

# CHT

400 °C/2h centrifugal roof fans with horizontal air outlet, aluminum hood



#### Fan:

- Support base in galvanized steel sheet.
- Backward curved impeller made of galvanized sheet steel.
- Bird protection grid.
- Aluminum rain cover.
- Approved in accordance with standard EN 12101-3, with certificate no.: 0370-CPR-1892.
- Maximum temperature of air to be carried: -25 °C +120 °C.

- Class F motors with ball bearings. IP55 protection. Except single-phase models, with IP54 protection. 1 or 2 speeds depending on model.
- Single-phase 230 V 50 Hz and three-phase 230/400 V 50 Hz.
- Working temperature: -25 °C +50 °C.

#### Finish:

- Anti-corrosive in galvanized steel sheet and aluminum.

#### Motor:

- Motors with IE3 efficiency for powers equal to or greater than 0.75 kW, except single-phase, 2-speed and 8-pole.

#### On request:

- Special windings for different voltages.
- ATEX certified Category 3.

## Order code

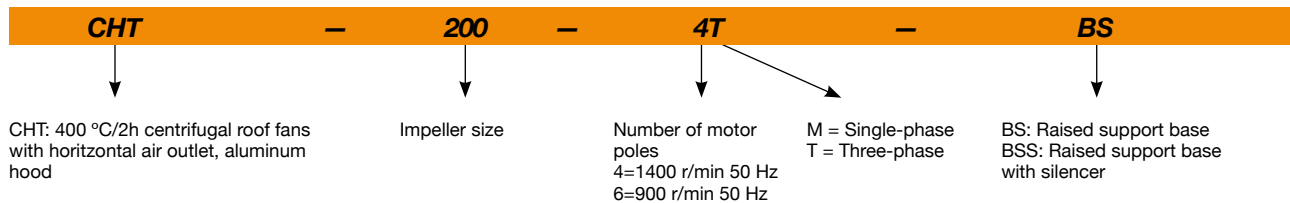

## Technical characteristics

Model	Speed (r/min)	Maximum admissible current (A)		Installed power (kW)	Maximum flow rate (m³/h)	Sound pressure level <sup>1</sup> dB (A)		Approx. weight (Kg)
		230V	400V			Inlet	Exhaust	
CHT-200-4T	1350	1.66	0.96	0.25	1450	36	43	25
CHT-200-4M	1380	1.70		0.25	1450	36	43	25
CHT-225-4T	1350	1.66	0.96	0.25	2100	40	46	25
CHT-225-4M	1380	2.60		0.25	2100	40	46	25
CHT-250-4T	1350	1.66	0.96	0.25	3100	44	49	34
CHT-250-4M	1380	2.60		0.25	3100	44	49	34
CHT-315-4T	1380	2.92	1.69	0.55	4950	47	53	39
CHT-315-4M	1380	3.30		0.55	4950	47	53	39
CHT-400-4T IE3	1420	2.82	1.62	0.75	7000	54	60	58
CHT-400-4M	1380	4.40		0.75	7000	54	60	57
CHT-400-6T	900	2.24	1.30	0.37	4500	43	49	56
CHT-450-4T IE3	1440	5.41	3.11	1.50	10200	58	63	74
CHT-450-6T	900	2.24	1.30	0.37	6720	46	53	59
CHT-500-6T IE3	945	4.68	2.69	1.10	12000	50	55	109
CHT-560-6T IE3	950	9.08	5.22	2.20	17300	53	59	130
CHT-630-6T IE3	960	15.60	8.99	4.00	24700	57	61	166

<sup>1</sup> Sound pressure level in dB(A) at a distance of 6 m and at maximum flow rate.



## Erp. (Energy Related Products)

Information on Directive 2009/125/EC can be downloaded from the SODECA website or the QuickFan selector programme.

## Acoustic characteristics

### Sound power spectrum Lw(A) in dB(A) per Hz frequency band

#### Values measured at inlet with maximum flow rate (Qmax)

	63	125	250	500	1000	2000	4000	8000
CHT-200-4	37	43	54	57	58	54	52	46
CHT-225-4	44	53	58	58	62	61	54	48
CHT-250-4	48	57	62	62	66	65	58	52
CHT-315-4	52	58	64	64	67	70	61	55
CHT-400-4	59	65	71	71	74	77	68	62
CHT-400-6	48	54	60	60	63	66	57	51
CHT-450-4	64	71	76	76	80	79	72	67
CHT-450-6	52	59	64	64	68	67	60	55
CHT-500-6	56	62	67	68	72	71	64	57
CHT-560-6	59	65	70	71	75	74	67	60
CHT-630-6	63	69	74	75	79	78	71	64

#### Values measured at exhaust with maximum flow rate (Qmax)

	63	125	250	500	1000	2000	4000	8000
CHT-200-4	41	46	60	62	63	63	58	53
CHT-225-4	43	52	62	66	69	66	59	53
CHT-250-4	46	55	65	69	72	69	62	56
CHT-315-4	51	63	71	73	74	74	66	58
CHT-400-4	58	70	78	80	81	81	73	65
CHT-400-6	47	59	67	69	70	70	62	54
CHT-450-4	62	74	82	84	85	82	75	67
CHT-450-6	52	64	72	74	75	72	65	57
CHT-500-6	52	66	74	78	77	74	68	62
CHT-560-6	56	70	78	82	81	78	72	66
CHT-630-6	59	73	81	85	74	81	75	69

## Dimensions mm

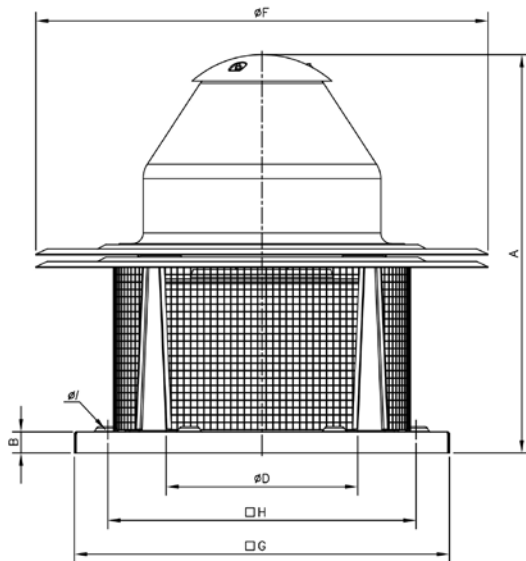

	A	B	øD*	øF	G	H	øI
CHT-200	530	20	250	570	450	360	12
CHT-225	548	20	250	570	450	360	12
CHT-250	620	30	355	726	560	450	12
CHT-315	670	30	355	726	560	450	12
CHT-400	755	40	500	856	710	590	12
CHT-450	770	40	500	856	710	590	12
CHT-500	846	40	630	1072	900	750	14
CHT-560	1035	40	710	1300	1100	900	14
CHT-630	1096	40	710	1300	1100	900	14

\* Recommended nominal tube diameter

### Characteristic curves

Q= Flow rate in m<sup>3</sup>/h, m<sup>3</sup>/s and cfm

Pe= Static pressure in mm H<sub>2</sub>O, Pa and inwg

**4M/4T=1500 r/min**

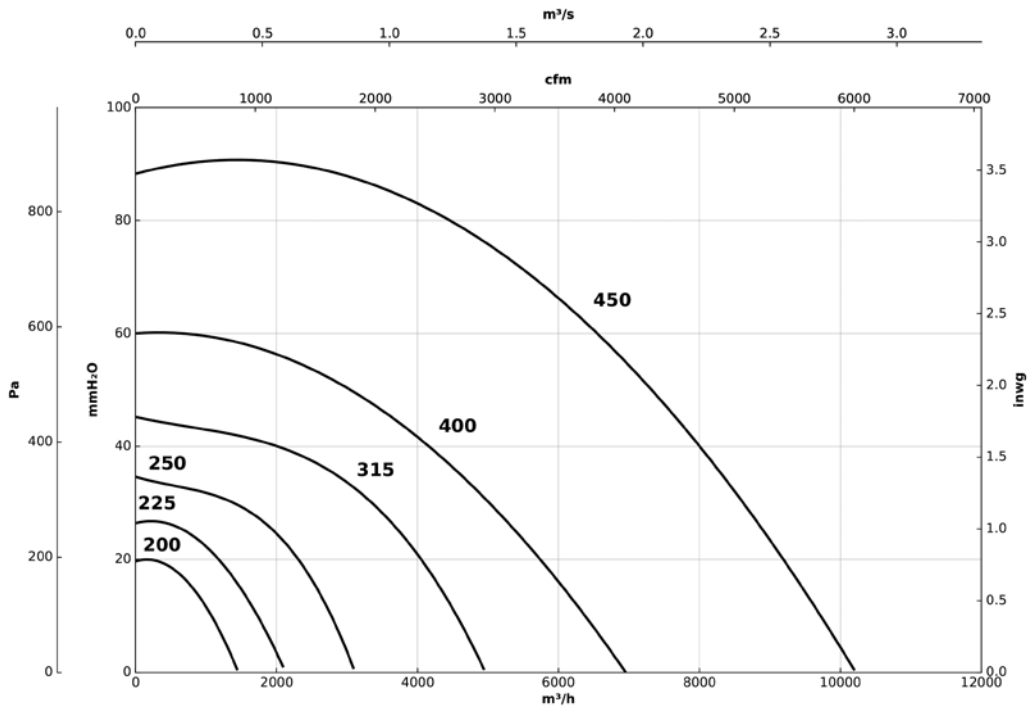

**6T=1000 r/min**

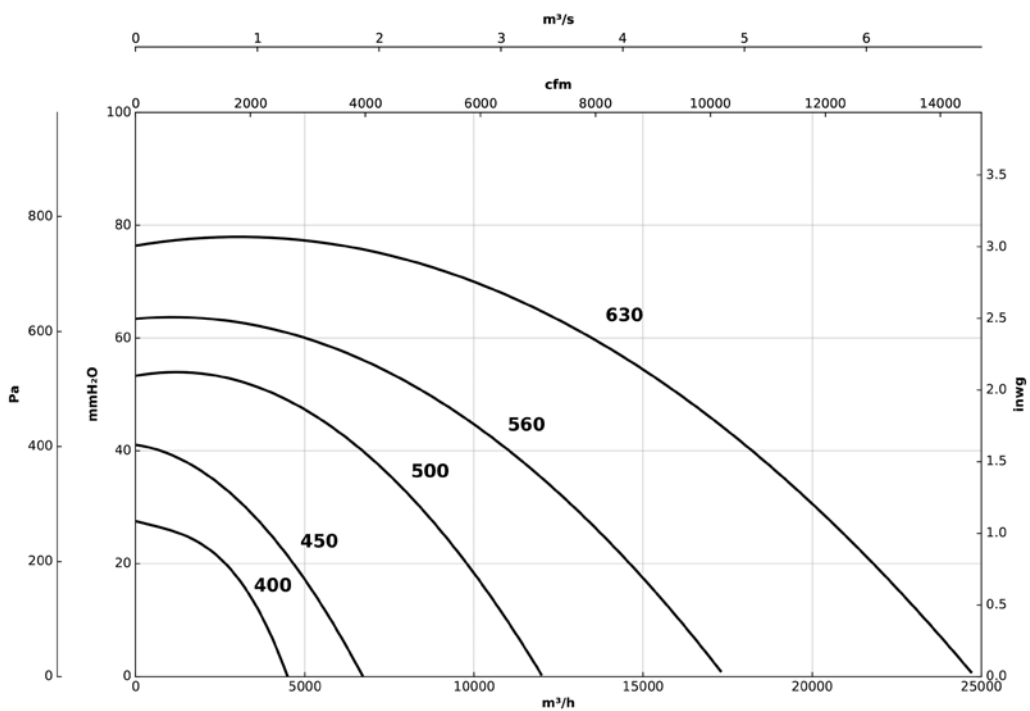

## Sound pressure variation depending on distance

The noise level may vary depending on the roof or tile structure.

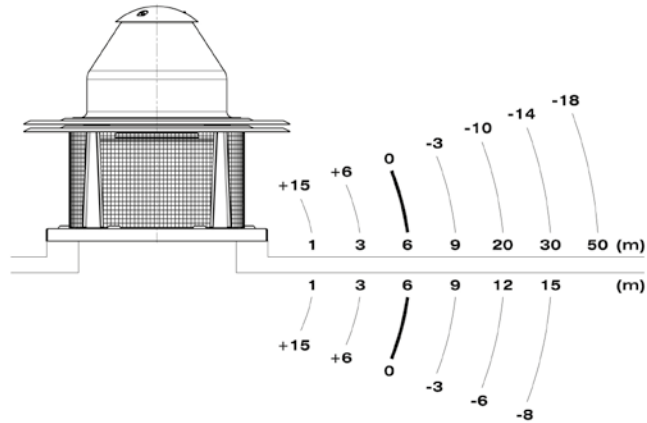

## Application example

Extract fans suitable for use in industrial kitchens

For the correct application of standard:

- C.T.E. Código Técnico de la Edificación (Technical Building Code). Basic Document SI on fire safety. Basic Document HS on health and safety.

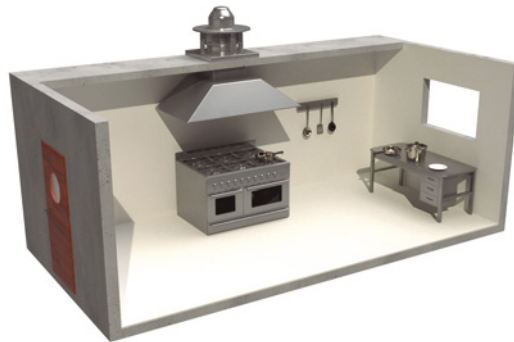

## Accessories



INT



C2V



RM



VSD3/A-RFT  
- VSD1/A-RFM



B



BAC

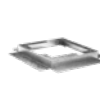

MS



PA



BS



BSS



PT



S



SI-PIR



SI-TEMP+HUMEDAD



SI-PRESIÓN



SI-FUENTE DE ALIMENTACIÓN



SI-VENT



SI-PRESOSTATO