

PF/EC

Plug Fan type high efficiency centrifugal fans, equipped with EC Technology IE5 motor with integrated electronics

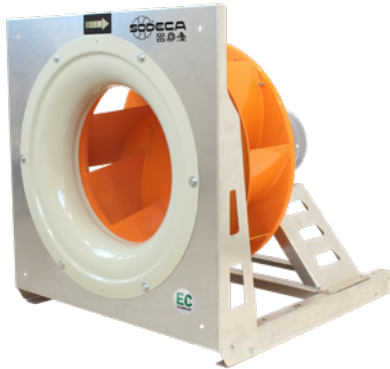

High-efficiency centrifugal Plug fans, for air treatment applications. Equipped with EC Technology IE5 motor with integrated electronics, specially designed to obtain high energy efficiency.

Fan:

- Galvanised sheet steel structure.
- Backward curved impeller made of sheet steel.
- Complete with a pressure measurement connection point for optional automatic flow and pressure control.
- Vertical execution not available for sizes 1871.

Motor:

- High efficiency EC Technology motors with integrated electronics, regulated by 0-10 V or 4-20 mA.
- IE5 efficiency motors, class F and IP55 protection.
- Single-phase 230 V 50/60 Hz and three-phase 400 V 50/60 Hz.
- Working temperature: -20 °C +60 °C.
- Modbus RTU and built-in alarm relay (three-phase models).

EC CONTROL: Supplied as an optional accessory. Control panel for ventilation systems with EC Technology motors with the electronics integrated in the motor itself. With the following characteristics:

- CPC: Constant pressure control.
- CFC: Constant flow control.
- DAY/NIGHT: Double pressure setpoint adjustment according to time of day.
- External sensor: compatible with temperature, humidity, air quality or CO sensor.
- Equipment preconfigured in constant pressure mode with 100 Pa set point.

Finish:

- Anti-corrosive in galvanized steel sheet.



EC TECHNOLOGY MOTOR with integrated electronics



EC CONTROL Supplied as an optional accessory

Order code

PF/EC	—	H	—	1856	—	4T	—	5.5	—	IE5		
↓		↓		↓		↓		↓		↓		
PF/EC: Plug Fan type high efficiency centrifugal fans, equipped with EC Technology IE5 motor with integrated electronics		H: Mounting with base. V: Vertical mount with spider mount.		Impeller size		Number of motor poles 2=3000 r/min 50/60 Hz 4=1500 r/min 50/60 Hz 6=900 r/min 50/60 Hz		T = Three-phase M = Single-phase		Motor power (HP)		IE5 motor

Technical characteristics

Model	Speed (r/min)	Maximum admissible current (A)		Installed power (kW)	Maximum flow rate (m³/h)	Sound pressure level¹ (dB (A))	Approx. weight (Kg)	According ErP*
		230V	400V					
PF/EC-925-2M-0.5-IE5	3000	3.30		0.37	2180	61	24	2020
PF/EC-925-2T-0.5-IE5	3000		1.12	0.37	2180	61	22	2020
PF/EC-1028-2M-1-IE5	3000	5.90		0.75	3255	64	24	2020
PF/EC-1028-2T-1-IE5	3000		2.20	0.75	3255	64	20	2020
PF/EC-1028-4M-0.33-IE5	1500	2.30		0.25	1630	49	22	Excluded
PF/EC-1028-4T-0.33-IE5	1500		0.72	0.25	1630	49	20	Excluded
PF/EC-1031-2T-2-IE5	3000		4.22	1.50	4540	68	24	2020
PF/EC-1031-4M-0.33-IE5	1500	2.30		0.25	2270	53	23	2020
PF/EC-1031-4T-0.33-IE5	1500		0.72	0.25	2270	53	22	2020
PF/EC-1135-2T-4-IE5	3000		8.17	3.00	6670	71	43	2020
PF/EC-1135-4T-0.5-IE5	1500		1.06	0.37	3335	56	34	2020
PF/EC-1240-2T-5.5-IE5	3000		10.77	4.00	9300	75	40	2020
PF/EC-1240-4T-0.75-IE5	1500		1.56	0.55	4650	60	29	2020
PF/EC-1445-4T-1.5-IE5	1500		3.07	1.10	6775	64	41	2020
PF/EC-1650-4T-3-IE5	1500		5.96	2.20	10290	77	67	2020
PF/EC-1856-4T-5.5-IE5	1500		10.62	4.00	15480	71	90	2020
PF/EC-1663-4T-5.5-IE5	1420		10.62	4.00	19770	76	97	2020
PF/EC-1871-6T-3-IE5	900		5.96	2.20	16320	74	160	2020

¹ Irradiated sound pressure level in dB(A) at a distance of 3 m and at maximum flow rate.

* In accordance with the ErP 2020 draft



Erp. (Energy Related Products)

Information on Directive 2009/125/EC can be downloaded from the SODECA website or the QuickFan selector programme.

Acoustic characteristics

Sound power spectrum Lw(A) in dB(A) per Hz frequency band

	63	125	250	500	1000	2000	4000	8000		63	125	250	500	1000	2000	4000	8000
PF/EC-925-2M-0.5 IE5	48	63	61	73	70	74	76	63	PF/EC-1135-2T-4 IE5	58	73	71	83	80	84	86	73
PF/EC-925-2T-0.5 IE5	48	63	61	73	70	74	76	63	PF/EC-1135-4T-0.5 IE5	43	58	56	68	65	69	71	58
PF/EC-1028-2M-1 IE5	51	66	64	76	73	77	79	66	PF/EC-1240-2T-5.5 IE5	62	77	75	87	84	88	90	77
PF/EC-1028-2T-1 IE5	51	66	64	76	73	77	79	66	PF/EC-1240-4T-0.75 IE5	47	62	60	72	69	73	75	62
PF/EC-1028-4M-0.33 IE5	36	51	49	61	58	62	64	51	PF/EC-1445-4T-1.5 IE5	51	66	64	76	73	77	79	66
PF/EC-1028-4T-0.33 IE5	36	51	49	61	58	62	64	51	PF/EC-1650-4T-3 IE5	68	78	86	88	87	89	80	70
PF/EC-1031-2T-2 IE5	55	70	68	80	77	81	83	70	PF/EC-1856-4T-5.5 IE5	63	72	85	81	84	85	79	65
PF/EC-1031-4M-0.33 IE5	40	55	53	65	62	66	68	55	PF/EC-1663-4T-5.5 IE5	77	82	88	90	88	85	78	70
PF/EC-1031-4T-0.33 IE5	40	55	53	65	62	66	68	55	PF/EC-1871-6T-3 IE5	72	73	82	85	87	88	84	71

Dimensions mm

Horizontal

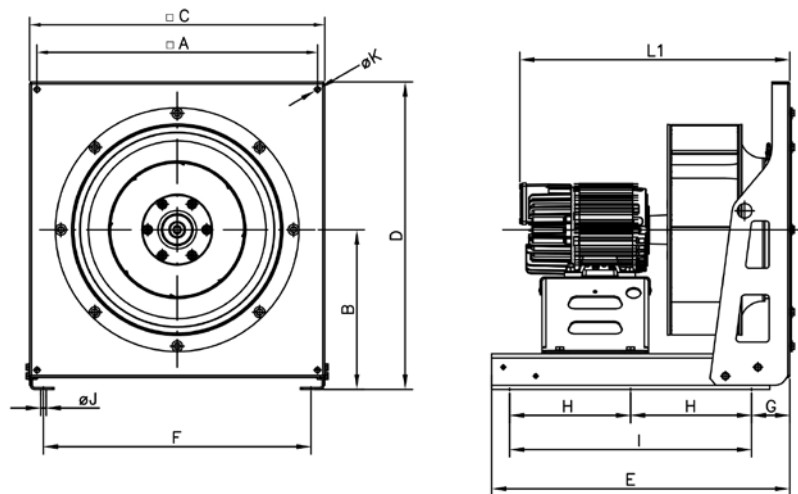

	□A	B	□C	D	E	F	G	H	I	ØJ	ØK	L1
PF/EC-H-925-2M-0.5-IE5	350	215	400	415	405	345	70	-	300	9	9	380
PF/EC-H-925-2T-0.5-IE5	350	215	400	415	405	345	70	-	300	9	9	390
PF/EC-H-1028-2M-1-IE5	375	215	400	415	405	345	70	-	300	9	9	435
PF/EC-H-1028-2T-1-IE5	375	215	400	415	405	345	70	-	300	9	9	406
PF/EC-H-1028-4M-0.33-IE5	375	215	400	415	405	345	70	-	300	9	9	395
PF/EC-H-1028-4T-0.33-IE5	375	215	400	415	405	345	70	-	300	9	9	406
PF/EC-H-1031-2T-2-IE5	375	215	400	415	505	345	70	-	400	9	9	422
PF/EC-H-1031-4M-0.33-IE5	375	215	400	415	505	345	70	-	400	9	9	411
PF/EC-H-1031-4T-0.33-IE5	375	215	400	415	505	345	70	-	400	9	9	422
PF/EC-H-1135-2T-4-IE5	475	270	500	520	505	445	70	-	400	9	9	506
PF/EC-H-1135-4T-0.5-IE5	475	270	500	520	505	445	70	-	400	9	9	458
PF/EC-H-1240-2T-5.5-IE5	475	270	500	520	505	445	70	-	400	9	9	530
PF/EC-H-1240-4T-0.75-IE5	475	270	500	520	505	445	70	-	400	9	9	495
PF/EC-H-1445-4T-1.5-IE5	580	335	630	650	605	575	70	-	500	9	9	542
PF/EC-H-1650-4T-3-IE5	600	335	630	650	705	575	70	-	600	9	9	653
PF/EC-H-1856-4T-5.5-IE5	700	430	760	810	705	705	70	-	600	9	9	688
PF/EC-H-1663-4T-5.5-IE5	700	430	760	810	805	710	70	-	700	11	9	770
PF/EC-H-1871-6T-3-IE5	800	545	960	1025	905	905	70	400	800	11	9	810

Dimensions mm

Vertical

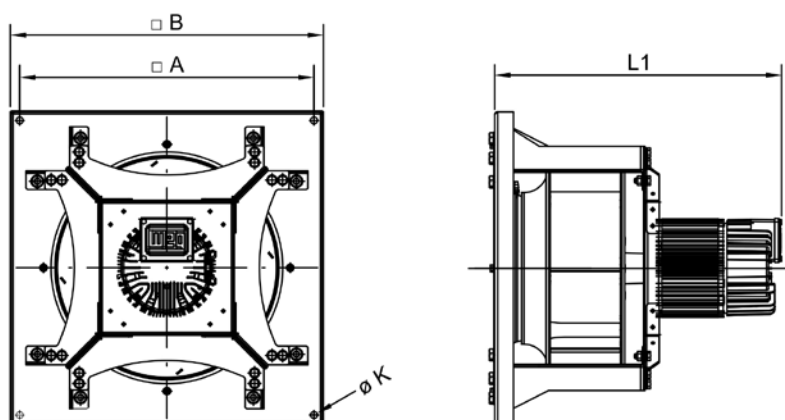

	□A	□B	ØK	L1
PF/EC-V-925-2M-0.5-IE5	367	400	11	380
PF/EC-V-925-2T-0.5-IE5	367	400	11	390
PF/EC-V-1028-2M-1-IE5	390	420	11	436
PF/EC-V-1028-2T-1-IE5	390	420	11	407
PF/EC-V-1028-4M-0.33-IE5	390	420	11	397
PF/EC-V-1028-4T-0.33-IE5	390	420	11	407
PF/EC-V-1031-2T-2-IE5	434	470	11	424
PF/EC-V-1031-4M-0.33-IE5	434	470	11	413
PF/EC-V-1031-4T-0.33-IE5	434	470	11	424
PF/EC-V-1135-2T-4-IE5	470	500	11	506
PF/EC-V-1135-4T-0.5-IE5	470	500	11	458
PF/EC-V-1240-2T-5.5-IE5	519	550	11	529
PF/EC-V-1240-4T-0.75-IE5	519	550	11	494
PF/EC-V-1445-4T-1.5-IE5	580	630	11	542
PF/EC-V-1650-4T-3-IE5	635	670	11	652
PF/EC-V-1856-4T-5.5-IE5	689	730	11	693
PF/EC-V-1663-4T-5.5-IE5	800	840	11	765

Characteristic curves

Q= Flow rate in m³/h, m³/s and cfm

Pe= Static pressure in mm H₂O, Pa and inwg

925-2M-0.5

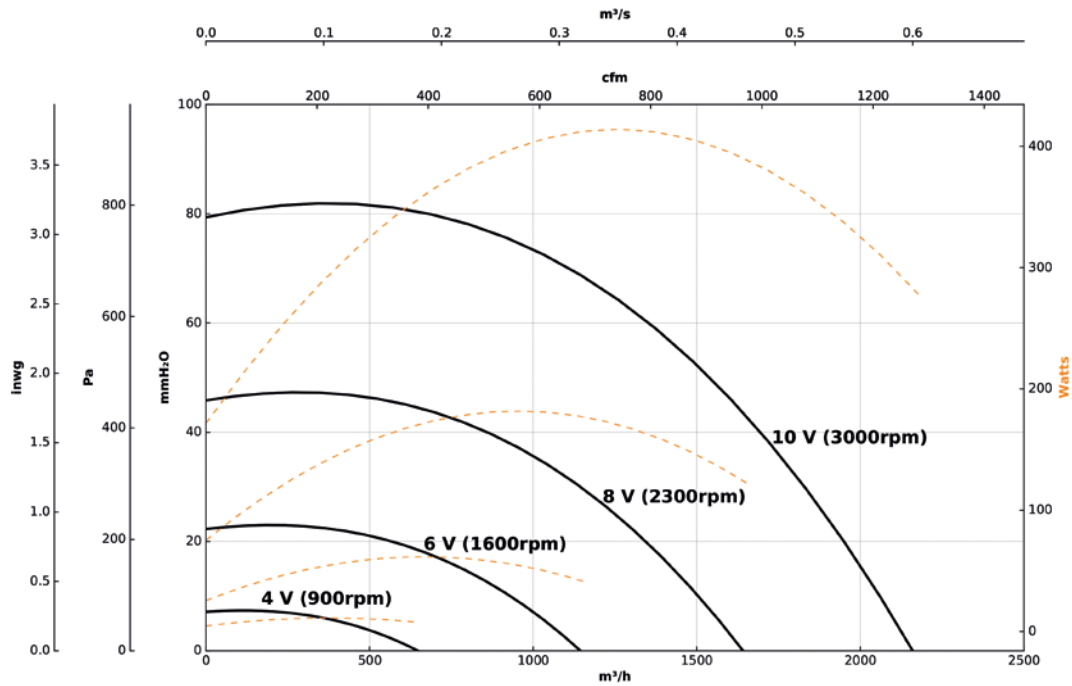

925-2T-0.5

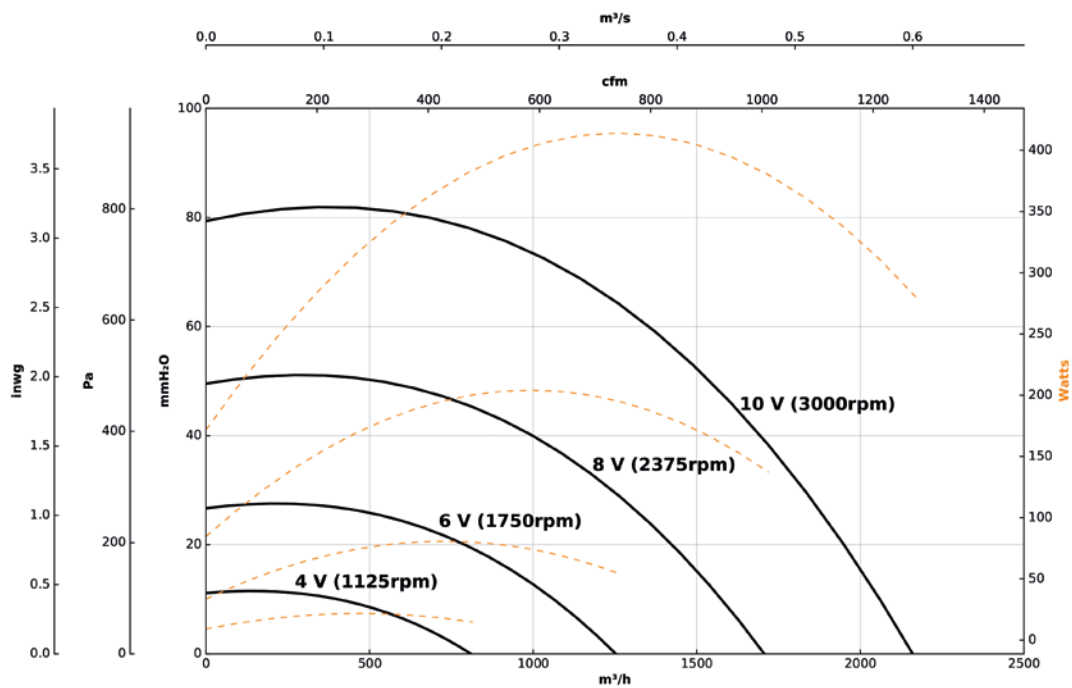

Characteristic curves

Q= Flow rate in m³/h, m³/s and cfm

Pe= Static pressure in mm H₂O, Pa and inwg

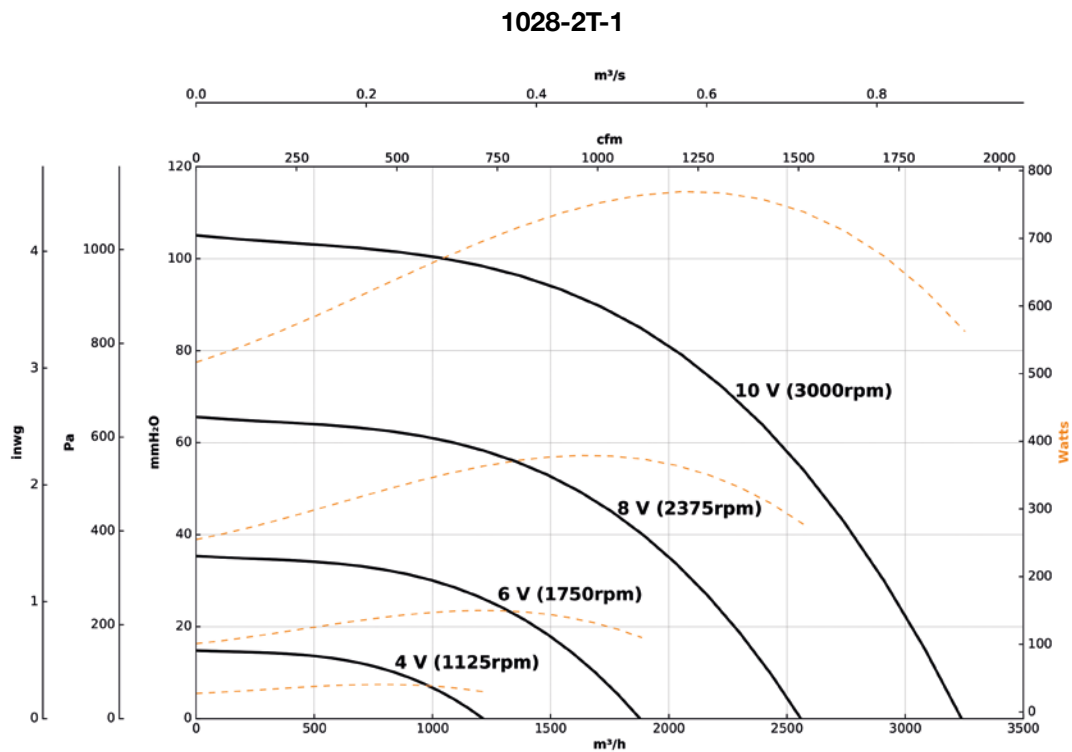
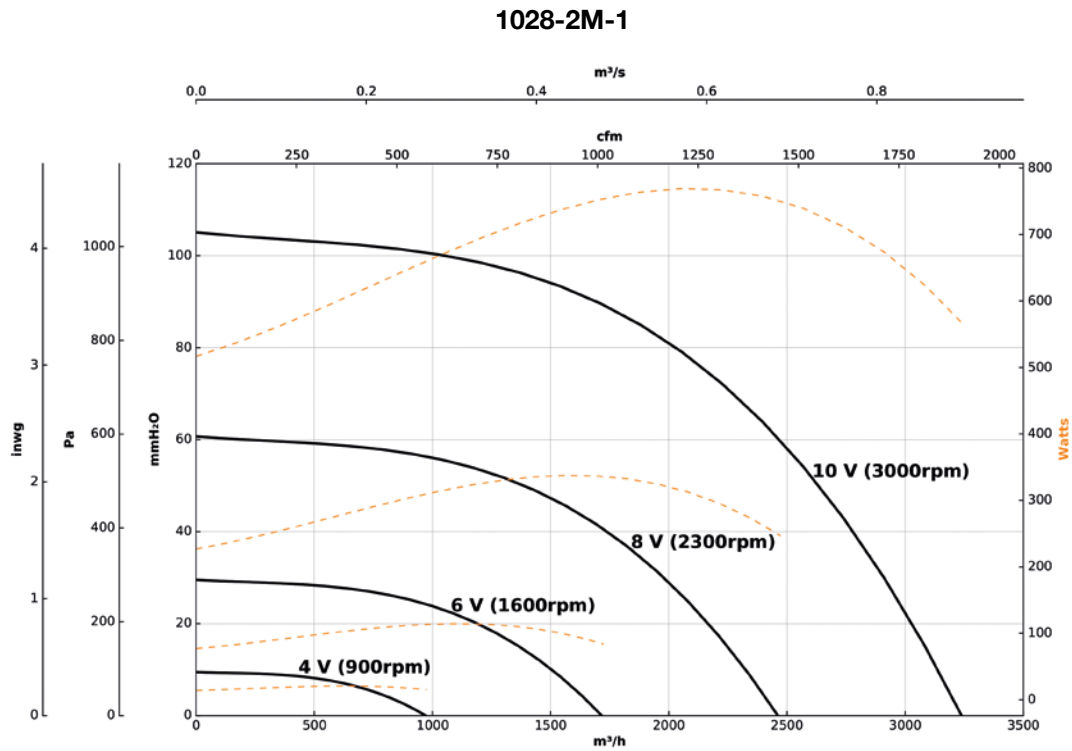

Characteristic curves

Q= Flow rate in m³/h, m³/s and cfm

Pe= Static pressure in mm H₂O, Pa and inwg

1028-4M-0.33

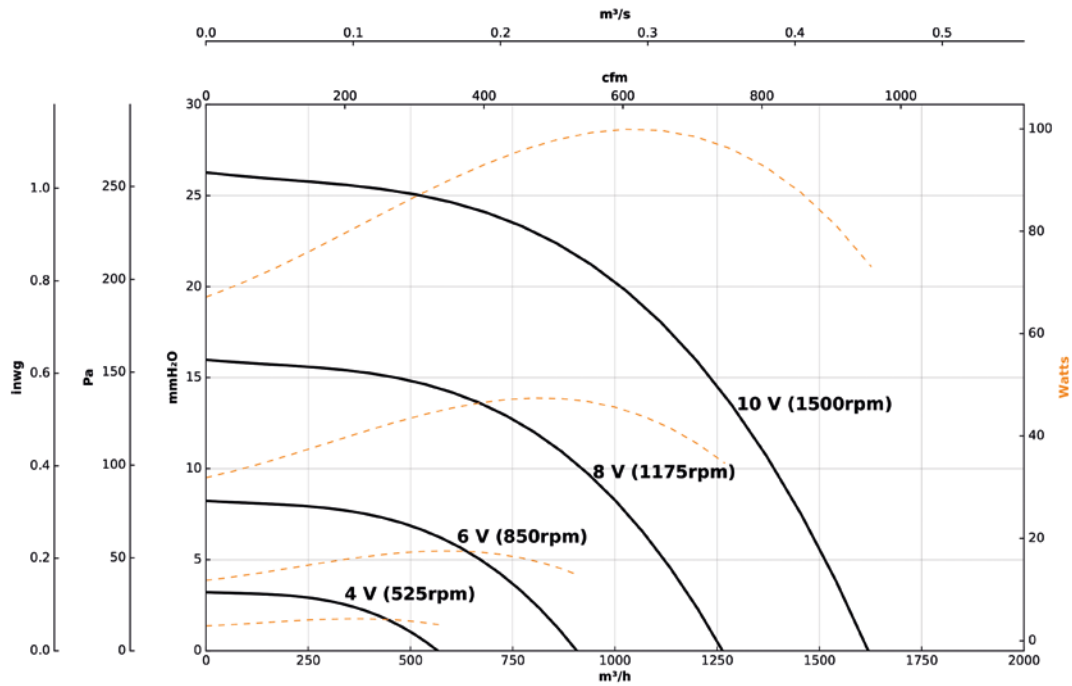

1028-4T-0.33

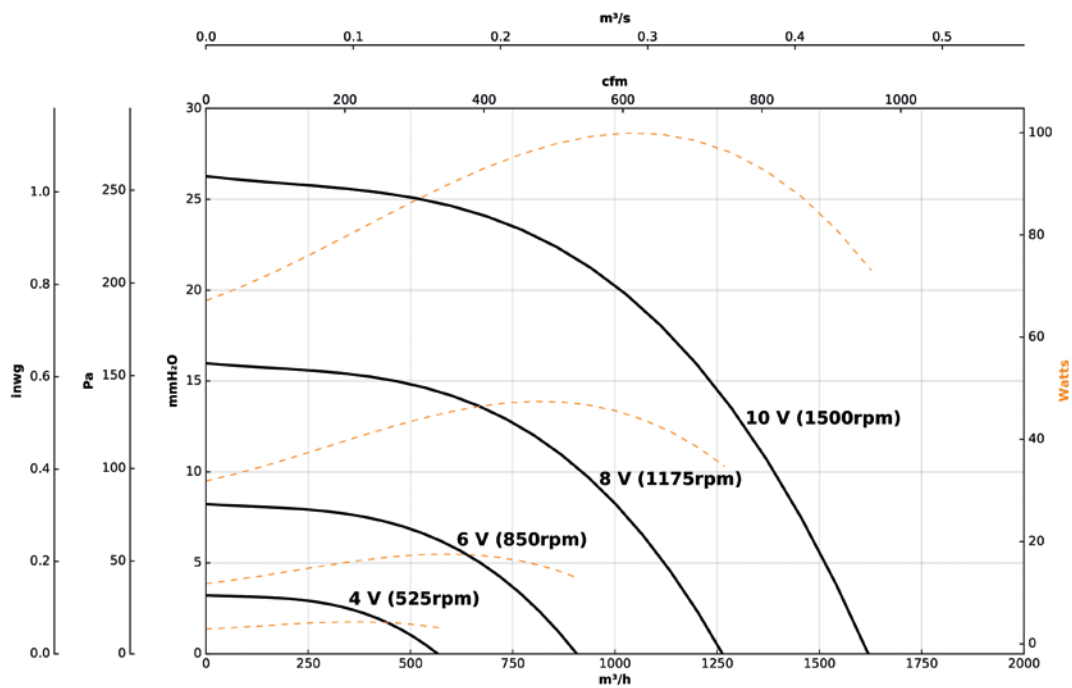

Characteristic curves

Q= Flow rate in m³/h, m³/s and cfm

Pe= Static pressure in mm H₂O, Pa and inwg

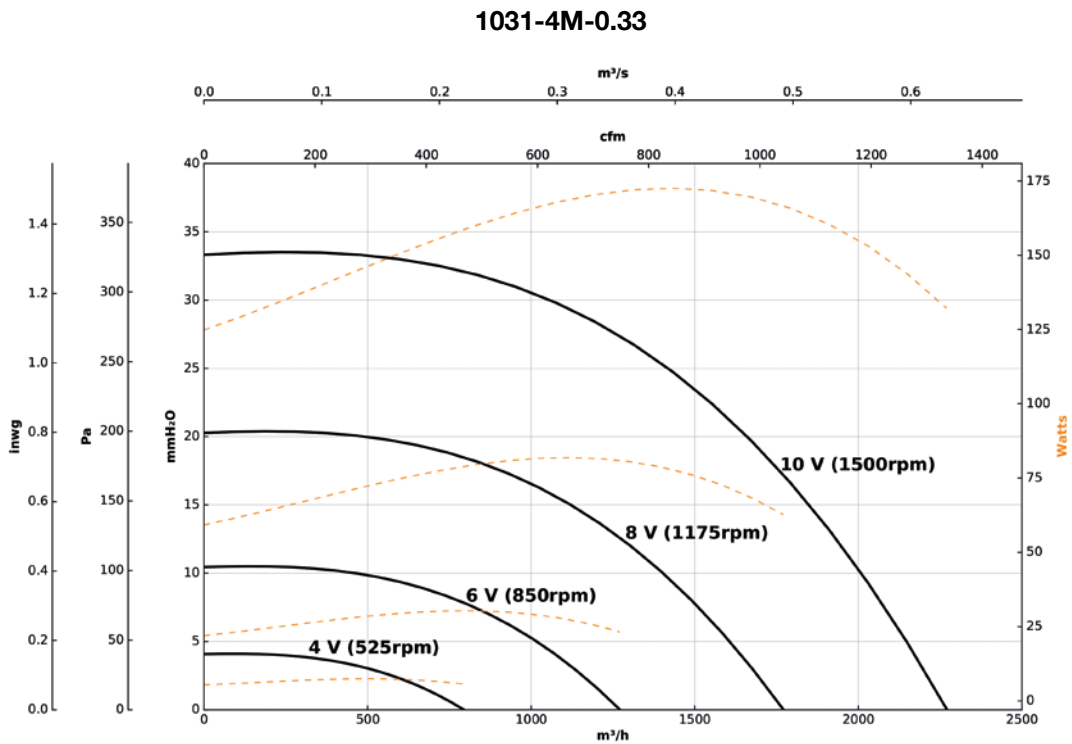
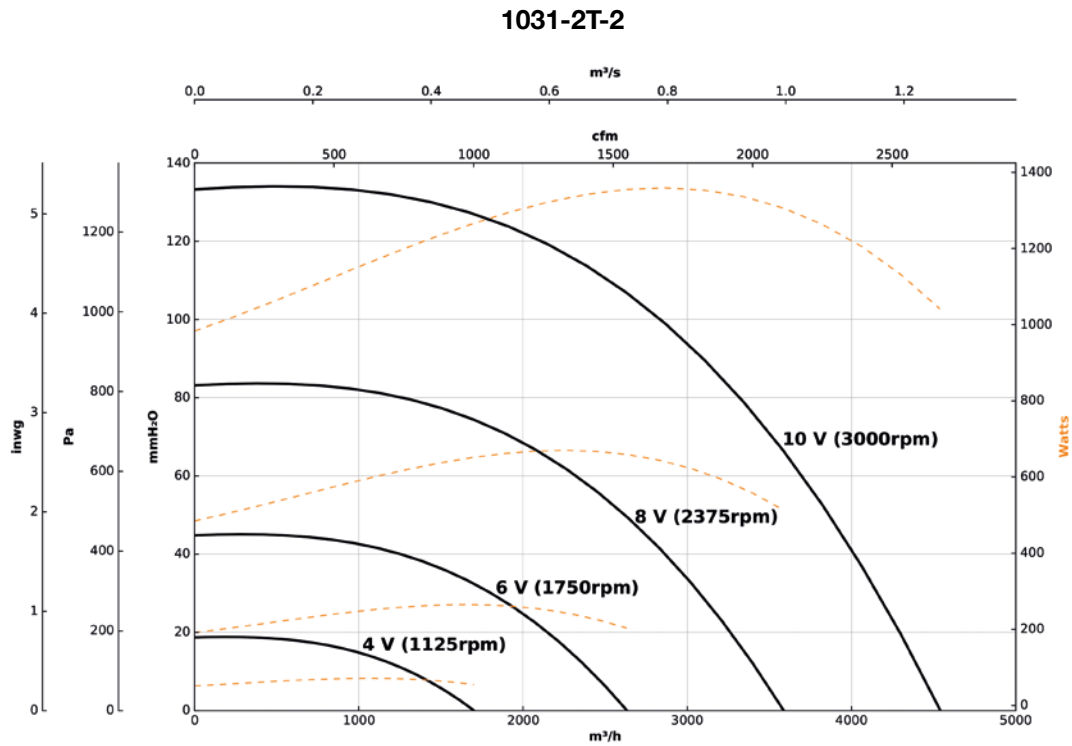

Characteristic curves

Q= Flow rate in m³/h, m³/s and cfm

Pe= Static pressure in mm H₂O, Pa and inwg

1031-4T-0.33

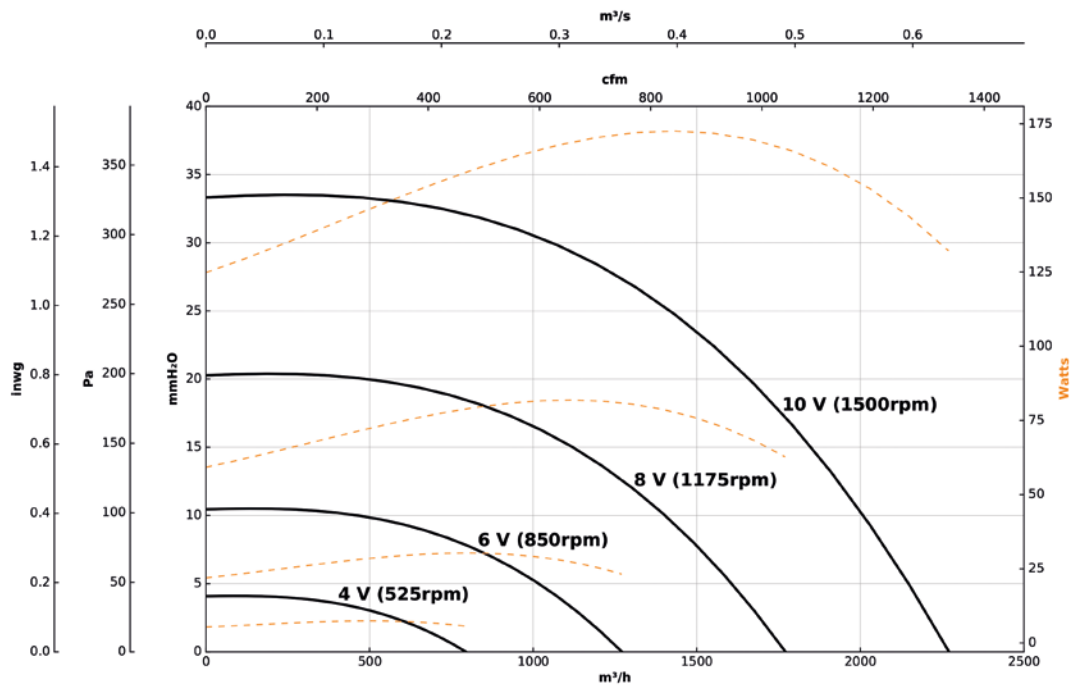

1135-2T-4

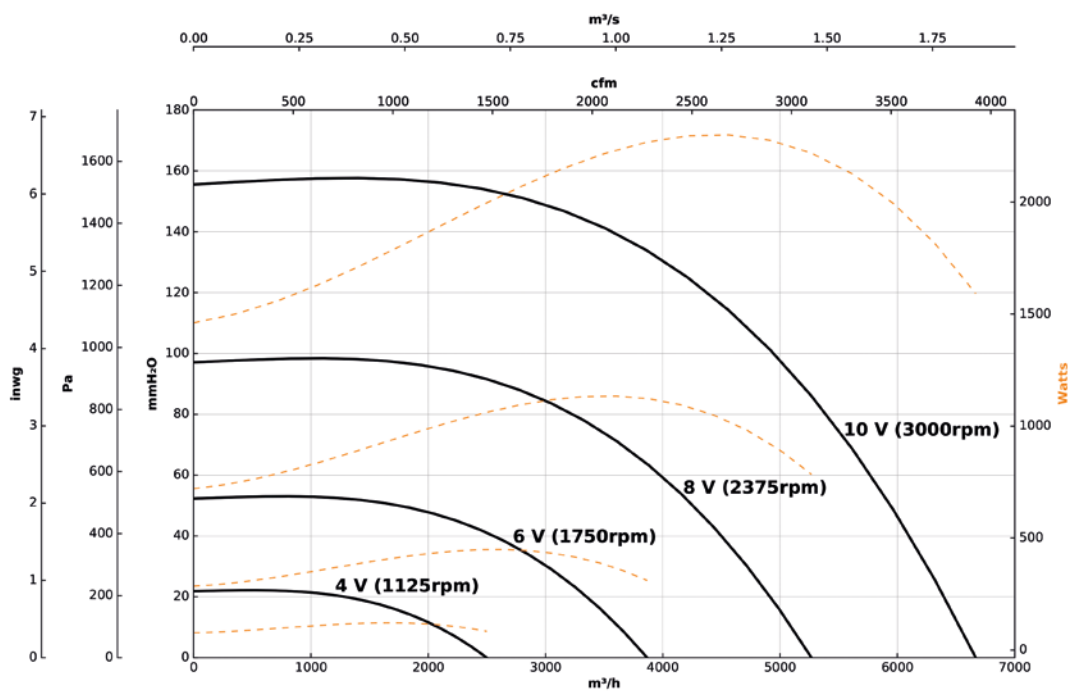

Characteristic curves

Q= Flow rate in m³/h, m³/s and cfm

Pe= Static pressure in mm H₂O, Pa and inwg

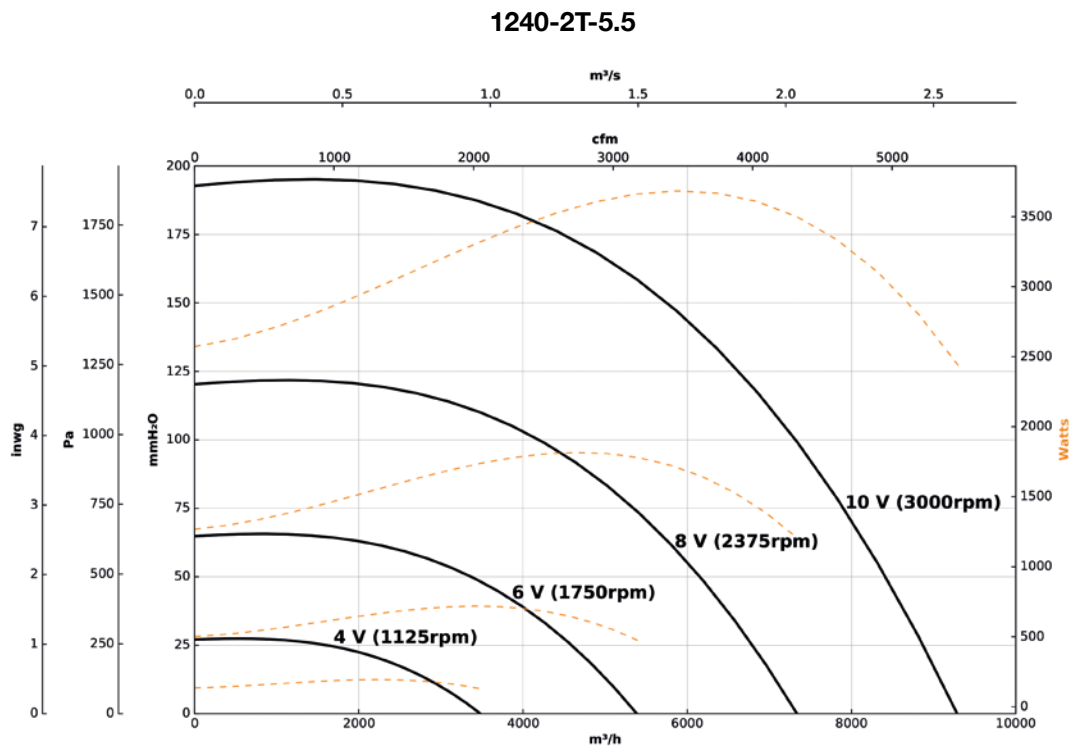
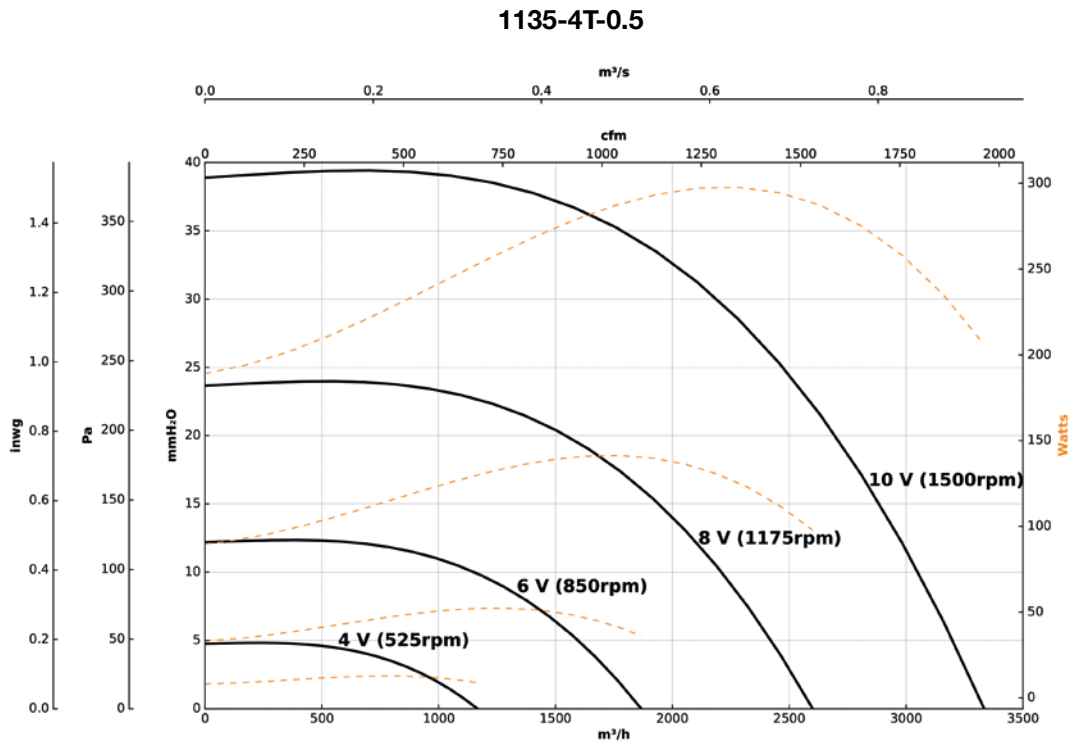

Characteristic curves

Q= Flow rate in m³/h, m³/s and cfm

Pe= Static pressure in mm H₂O, Pa and inwg

1240-4T-0.75

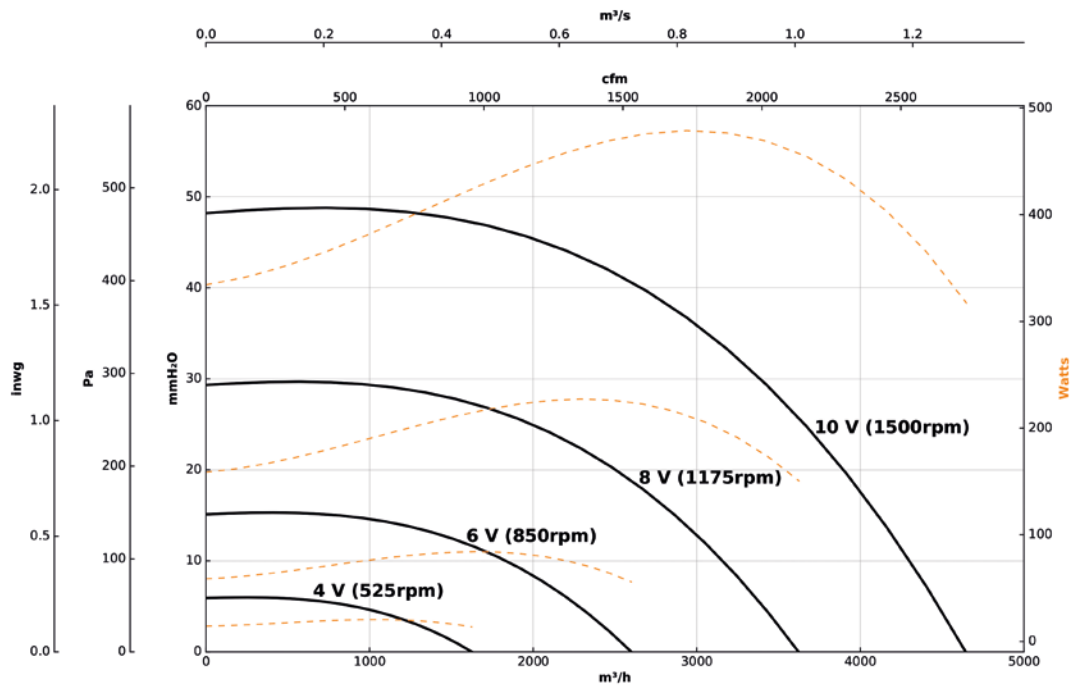

1445-4T-1.5

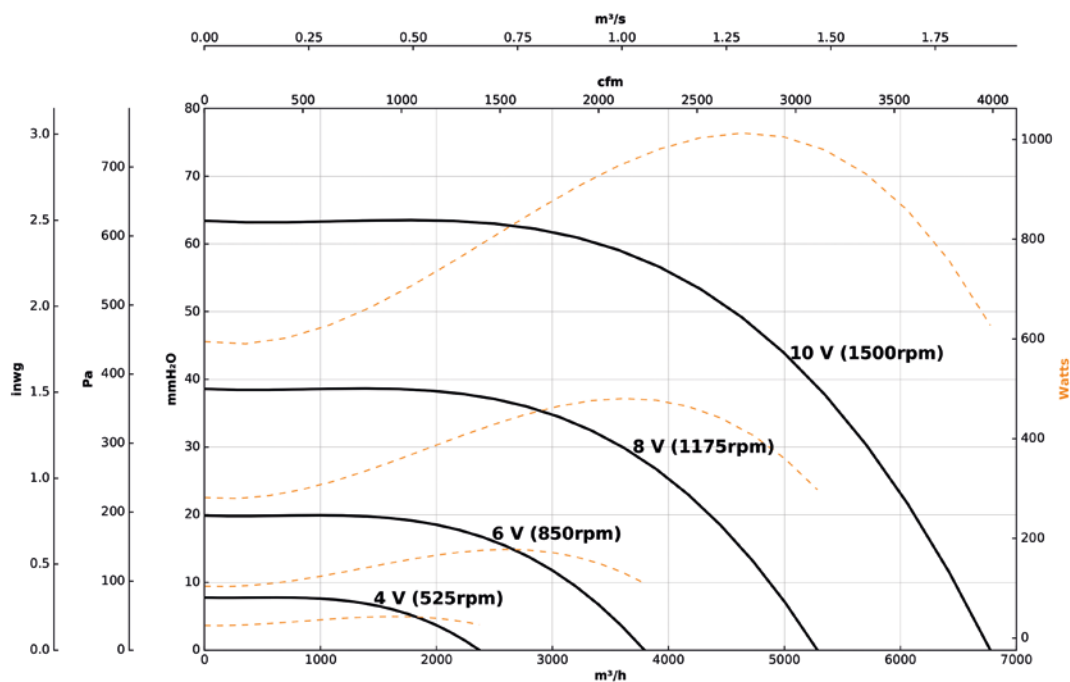

Characteristic curves

Q= Flow rate in m³/h, m³/s and cfm

Pe= Static pressure in mm H₂O, Pa and inwg

1650-4T-3

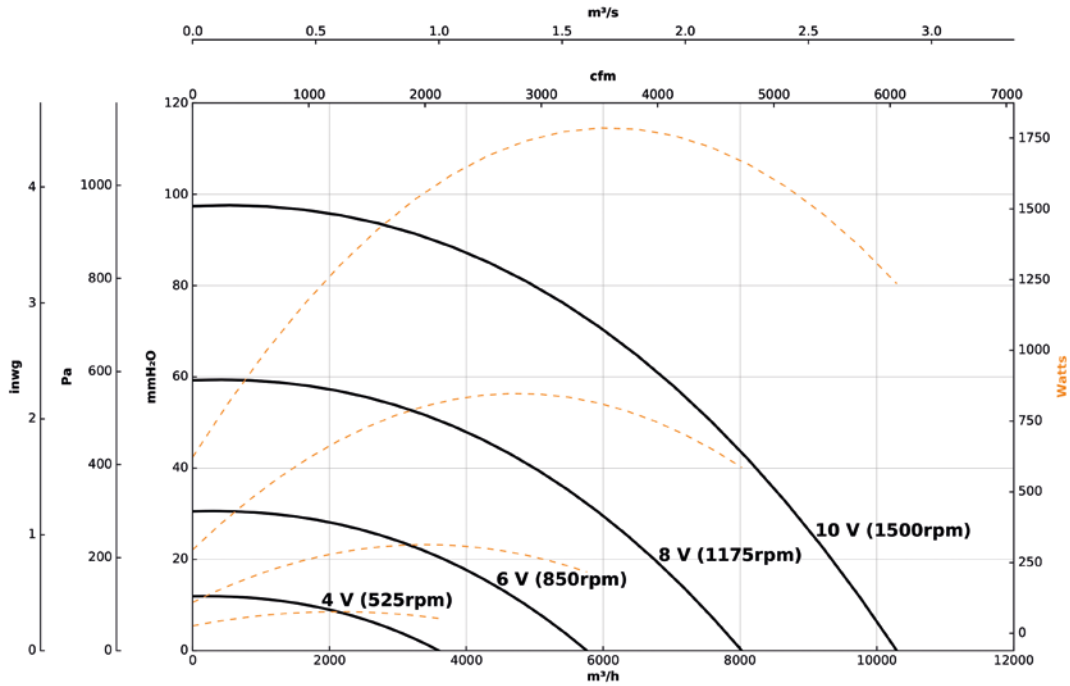

1856-4T-5.5

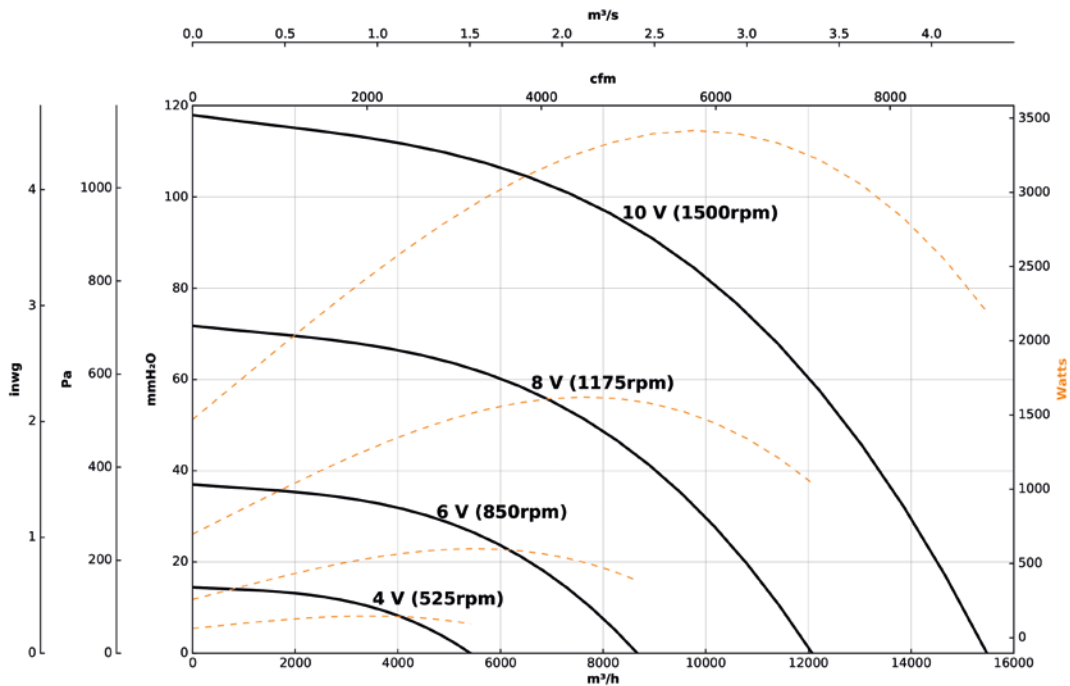

Characteristic curves

Q= Flow rate in m³/h, m³/s and cfm

Pe= Static pressure in mm H₂O, Pa and inwg

1663-4T-5.5

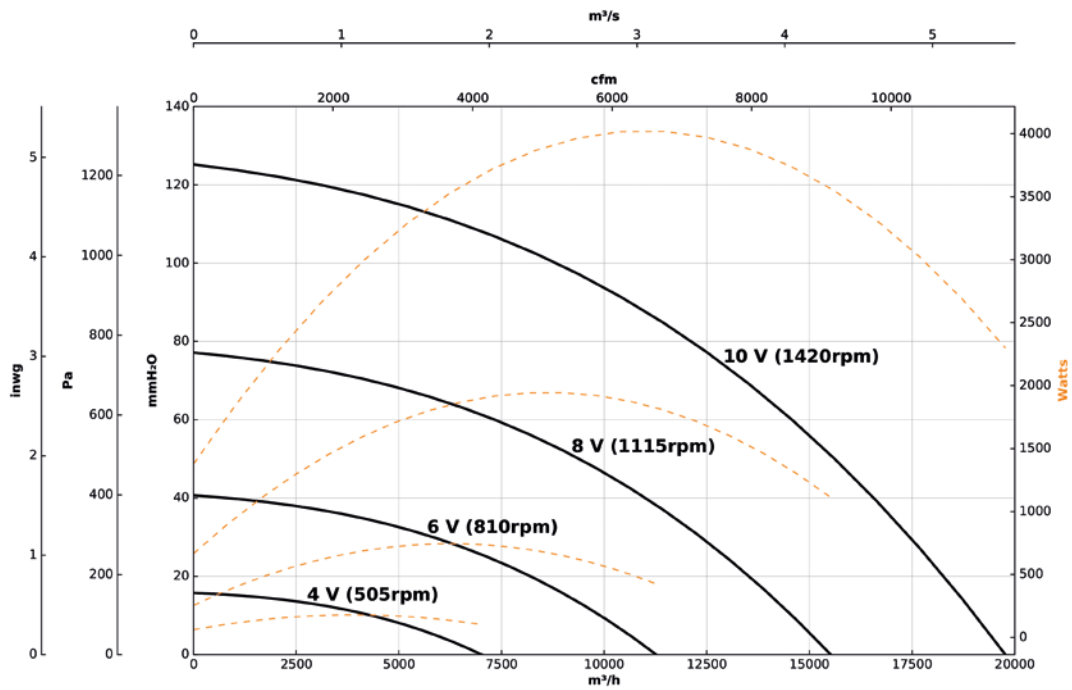

1871-6T-3

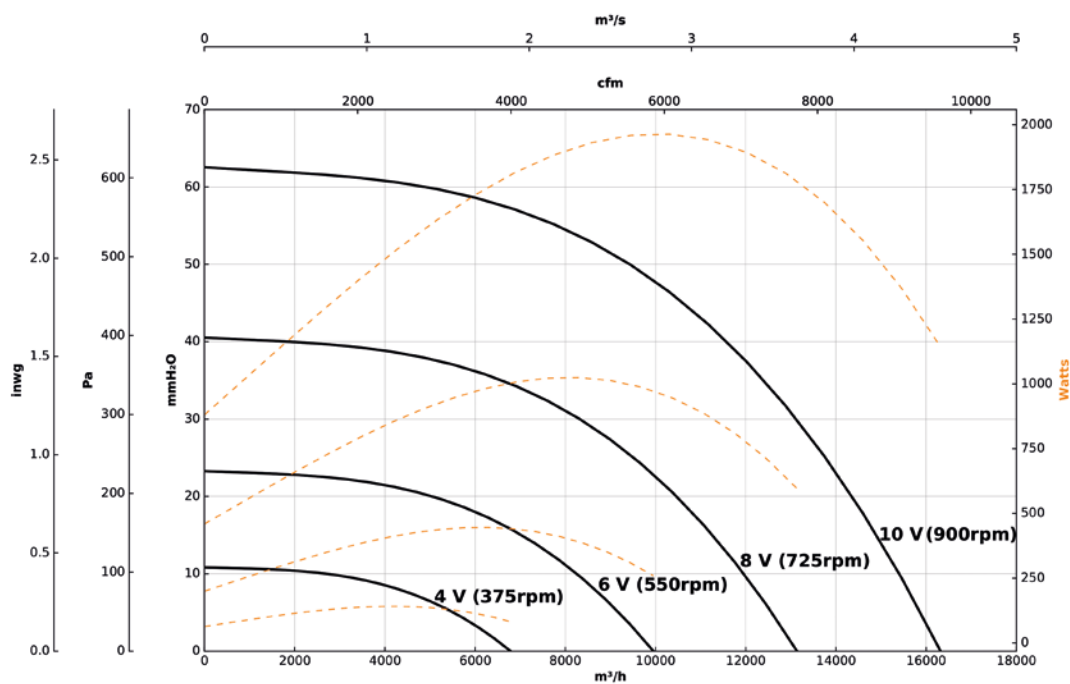

Pressure connection

Air flow rate → Q [m³/h]
 Calibration factor → K
 Difference in pressure → Δp [Pa]

$$Q = K x \sqrt{\Delta p}$$

	K Factor*
PF/EC-925	77
PF/EC-1028	94
PF/EC-1031	107
PF/EC-1135	143
PF/EC-1240	168
PF/EC-1445	245
PF/EC-1650	225
PF/EC-1856	310
PF/EC-1663	397
PF/EC-1871	513

* Values given for p = 1.2 kg/m³ and at 20 °C.

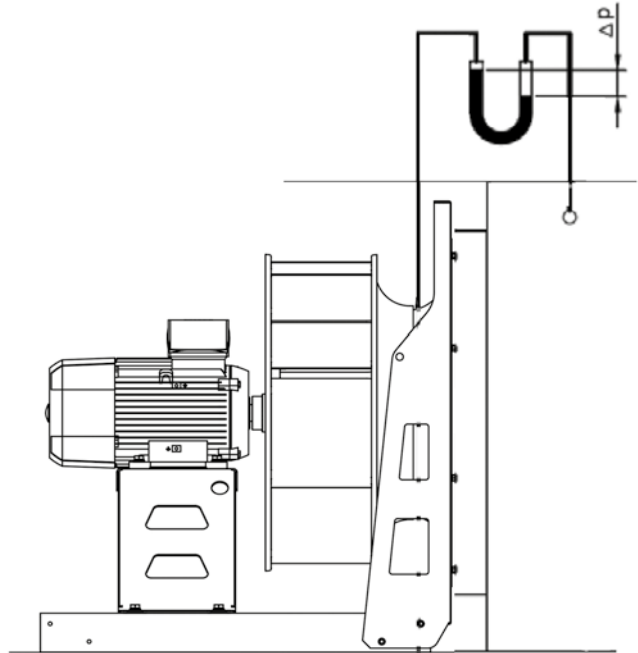

Accessories



SI-PRESIÓN



INT



EC CONTROL



MTP



RPA



B



BD