

CMR/EW

**HIGHLY EFFICIENT
IE3-COMPLIANT
THREE-PHASE MOTORS**

VARIABLE SPEED DRIVE
VSD: Variable Speed Drive.
- VSD1/A-RFM
- VSD3/A-RFT
Supply on request



CONTROL
Supply optional accessory

SUPPLY
VSD1/A-RFM:
220-240 V 50/60 Hz
VSD3/A-RFT:
380-415 V 50/60 Hz

High-efficiency centrifugal single-inlet, medium-pressure fans with a direct motor and impeller with backward-facing blades fitted with IE3 asynchronous motor adjustable electronically.

Fan:

- Steel sheet casing
- Impeller with backward-curved blades made from robust sheet steel

Motor and electronic variable speed:

- Motors with IE3 efficiency adjustable electronically.
- The variable speed drive VSD will be supplied as per order.
- Electronic variable speed drive (VSD) can be adjusted by external 0-10 V signal.
- It is advisable to install sinusoidal filters between the fan and the electronic variable speed drive (VSD) when they are far apart.
- Electronic variable speed drive (VSD), available with single-phase 220-240 V 50/60 Hz input (VSD1/B type) or three-phase 380-415 V 50/60 Hz (VSD3/B type). Standard protection IP20 til 15 Hp, higher powers IP55. On demand IP66 protection til 10 CV
- By default, the electronic variable speed drive (VSD) is delivered programmed for constant speed.
- Working fan temperature: -25 °C +120 °C.

Working temperature (VSD):

- -25 °C +50 °C.
- Class F motors with ball bearings, IP55 protection.
- Three-phase 230/400 V. 50 Hz. (up to 4kW) and 400/690 V 50 Hz. (power over 4kW)

Finish:

- Anticorrosive finish in polyester resin polymerised at 190°C, after alkaline degreasing with nanotechnology treatment and phosphate-free.

On request:

- Fan designed to transport air up to 250°C.
- Stainless steel fans

Fan order code

CMR/EW — 1031 — 2T — IE3

CMR/EW: High efficiency robust centrifugal single-inlet, medium-pressure fans fitted with an impeller with backward-facing blades, "Efficient work"

Impeller size

Number of motor poles:
2T=2900 r/min
4T=1440 r/min
6T=950 r/min

Three-phase motor IE3

CMR/EW — 1031 — 2T — IE3 — VSD1 — D

CMR/EW: High efficiency robust centrifugal single-inlet, medium-pressure fans fitted with an impeller with backward-facing blades, "Efficient work"

Impeller size

Number of motor poles:
2T=2900 r/min
4T=1440 r/min
6T=950 r/min

Three-phase motor IE3

VSD1: Fitted with VSD1/A-RFM, electronic variable speed, single phase power supply 220-240 V 50/60 Hz.

VSD3: Fitted with VSD3/A-RFT, electronic variable speed, three-phase power supply 380-415 V 50/60 Hz.

D: Standard version, VSD supplied programmed for constant speed.
P: Supplied with VSD programmed for pressure control and Si-Presión pressure transmitter
K: Supplied with VSD programmed for pressure control and built into a BOXPRES KIT/B box. Only available for fans with motor power less than or equal to 2.2 kW.



EFFICIENT WORK



Technical characteristics

Model	Speed min/max (r/min)	Single-phase VSD 230 V 50/60 Hz		Three-phase VSD 400 V 50/60 Hz		Maximum current Motor 50 Hz (A)			Installed power (kW)	Maximum airflow min/max (m³/h)	Sound pressure level min/max dB(A)	Weight approx. (Kg)
		Maximum current input (A)	Model VSD	Maximum current input (A)	Model VSD	230V	400V	690V				
CMR/EW-1031-2T	1150/2875	16.15	VSD1/A-RFM-2	4.49	VSD3/A-RFT-2	5.34	3.07	-	1.50	2065 / 5160	60 / 80	44.3
CMR/EW-1135-2T	1165/2910	23.25	VSD1/A-RFM-3	6.46	VSD3/A-RFT-3	7.32	4.21	-	2.20	3125 / 7800	63 / 83	54.9
CMR/EW-1240-2T	1160/2900	-	-	9.44	VSD3/A-RFT-5.5	13.00	7.50	-	4.00	4440 / 11100	66 / 86	93.5
CMR/EW-1240-4T	570/1420	8.32	VSD1/A-RFM-1	2.31	VSD3/A-RFT-1	2.82	1.62	-	0.75	2330 / 5800	51 / 71	70.5
CMR/EW-1445-2T	1175/2935	-	-	17.45	VSD3/A-RFT-10	-	13.90	8.06	7.50	6605 / 16500	67 / 87	126.0
CMR/EW-1445-4T	580/1455	11.87	VSD1/A-RFM-2	3.30	VSD3/A-RFT-2	4.07	2.34	-	1.10	3200 / 8030	52 / 72	92.5
CMR/EW-1650-2T	1170/2925	-	-	25.48	VSD3/A-RFT-15	-	19.60	11.40	11.00	7540 / 18850	69 / 89	178.0
CMR/EW-1650-4T	575/1440	15.78	VSD1/A-RFM-2	4.38	VSD3/A-RFT-2	5.41	3.11	-	1.50	4195 / 10500	54 / 74	114.0
CMR/EW-1650-6T	375/940	8.69	VSD1/A-RFM-1	2.41	VSD3/A-RFT-1	3.36	1.93	-	0.75	2955 / 7410	44 / 64	114.0
CMR/EW-1856-4T	575/1440	-	-	7.20	VSD3/A-RFT-5.5	10.70	6.15	-	3.00	6050 / 15150	59 / 79	152.0
CMR/EW-1856-6T	380/945	12.43	VSD1/A-RFM-2	3.45	VSD3/A-RFT-2	4.68	2.69	-	1.10	4040 / 10050	50 / 70	146.5
CMR/EW-2063-4T	585/1465	-	-	12.81	VSD3/A-RFT-7.5	-	10.30	5.97	5.50	9765 / 24450	60 / 80	226.0
CMR/EW-2063-6T	380/950	16.64	VSD1/A-RFM-2	4.62	VSD3/A-RFT-2	6.43	3.70	-	1.50	6440 / 16100	51 / 71	208.5
CMR/EW-2271-4T	590/1470	-	-	25.10	VSD3/A-RFT-15	-	21.40	12.40	11.00	13890 / 34610	65 / 85	315.0
CMR/EW-2271-6T	390/970	-	-	7.39	VSD3/A-RFT-5.5	12.00	6.91	-	3.00	9145 / 22750	56 / 76	293.5
CMR/EW-2380-4T	590/1475	-	-	49.98	VSD3/A-RFT-30	-	40.60	23.50	22.00	19200 / 48000	63 / 83	416.0
CMR/EW-2380-6T	390/970	-	-	17.59	VSD3/A-RFT-10	-	14.80	8.58	7.50	12060 / 30000	55 / 75	363.0

Acoustic features at maximum speed

The specified values are determined according to free field measurements of sound levels in dB(A) at an equivalent distance of twice the fan's span plus the impeller's diameter, with a minimum of 1.5 m.

Sound power Lw(A) spectrum in dB(A) via frequency band in Hz.

Model	63	125	250	500	1000	2000	4000	8000	Model	63	125	250	500	1000	2000	4000	8000
CMR/EW-1031-2T	65	78	78	91	86	86	86	79	CMR/EW-1856-4T	69	78	91	87	90	91	85	71
CMR/EW-1135-2T	72	79	77	89	87	93	92	79	CMR/EW-1856-6T	61	69	81	83	80	81	71	60
CMR/EW-1240-2T	68	83	81	93	90	94	96	83	CMR/EW-2063-4T	80	85	91	93	91	88	81	73
CMR/EW-1240-4T	56	70	76	79	79	80	70	59	CMR/EW-2063-6T	69	70	82	82	81	83	73	63
CMR/EW-1445-2T	73	85	83	95	93	97	99	89	CMR/EW-2271-4T	83	84	93	96	98	99	95	82
CMR/EW-1445-4T	59	72	78	83	80	83	78	64	CMR/EW-2271-6T	73	73	87	86	90	90	79	68
CMR/EW-1650-2T	73	81	85	99	97	99	99	88	CMR/EW-2380-4T	76	78	94	91	96	97	93	82
CMR/EW-1650-4T	64	74	82	84	83	85	76	66	CMR/EW-2380-6T	68	70	86	83	88	89	85	74
CMR/EW-1650-6T	53	65	72	77	73	69	62	54									

Dimensions in mm

CMR/EW-1031...2271

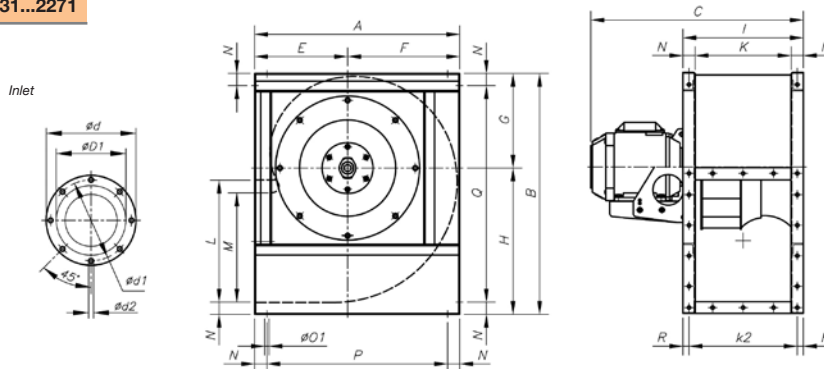

Model	A	B	C	øD1*	ød	ød1	ød2	E	F	G	H	I	K	k2	L	M	N	øO1	P	Q	R
CMR/EW-1031-2T	542	626	573,5	315	383	356	M8	250	292	245	381	320	250	285	315	276	35	11	472	556	17,5
CMR/EW-1135-2T	600	696	656	355	425	398	M8	275	325	273	423	350	280	315	355	310	35	11	530	626	17,5
CMR/EW-1240-2T	673	790	728	400	472	444	M10	305	368	310	480	395	315	355	400	358	40	11	593	710	20
CMR/EW-1240-4T	673	790	590	400	472	444	M10	305	368	310	480	395	315	355	400	358	40	11	593	710	20
CMR/EW-1445-2T	765	880	810	450	522	494	M10	350	415	339	541	445	355	403	450	404	45	11	675	790	21
CMR/EW-1445-4T	765	880	649	450	522	494	M10	350	415	339	541	445	355	403	450	404	45	11	675	790	21
CMR/EW-1650-2T	832	970	961	500	582	555	M10	375	457	378	592	490	400	450	500	445	45	13	742	880	20
CMR/EW-1650-4T	832	970	715	500	582	555	M10	375	457	378	592	490	400	450	500	445	45	13	742	880	20
CMR/EW-1650-6T	832	970	695	500	582	555	M10	375	457	378	592	490	400	450	500	445	45	13	742	880	20
CMR/EW-1856-4T	925	1084	832	560	645	615	M10	415	510	426	658	550	450	500	560	493	50	13	825	984	25
CMR/EW-1856-6T	925	1084	771	560	645	615	M10	415	510	426	658	550	450	500	560	493	50	13	825	984	25
CMR/EW-2063-4T	1037	1218	973	630	720	688	M10	465	572	477	741	620	500	560	630	530	60	13	917	1098	30
CMR/EW-2063-6T	1037	1218	893	630	720	688	M10	465	572	477	741	620	500	560	630	530	60	13	917	1098	30
CMR/EW-2271-4T	1173	1375	1126	710	800	768	M12	525	648	538	837	690	560	625	710	603	65	13	1043	1245	32,5
CMR/EW-2271-6T	1173	1375	1039	710	800	768	M12	525	648	538	837	690	560	625	710	603	65	13	1043	1245	32,5

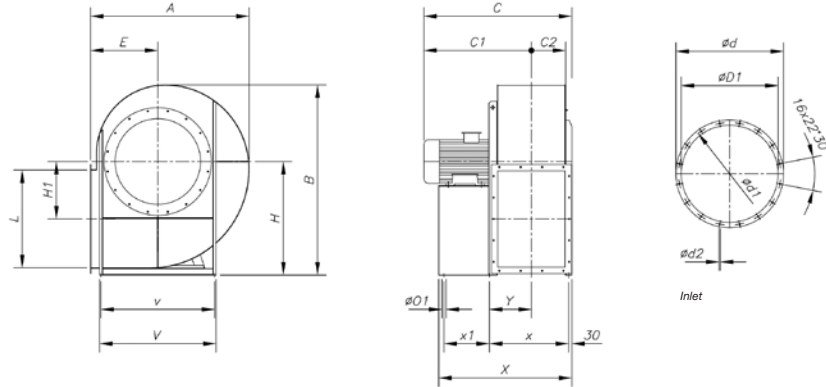

Dimensions in mm

CMR/EW-2380

Model	A	B	C	C1	C2	D1	d	d1	d2	E	H	H1	L	O1	V	v	X	x	x1	Y
CMR-2380-4T	1350	1660	1245	895	345	808	903	861	11,5	560	1000	500	820	17	930	870	1103	668	370	352,5
CMR-2380-6T	1350	1660	1175	825	345	808	903	861	11,5	560	1000	500	820	17	930	870	1051	651	340	342,5

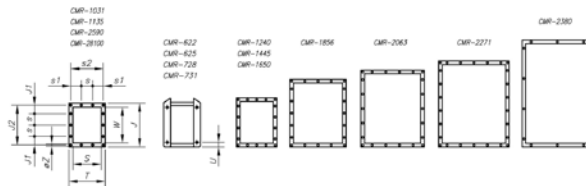

Model	T	J	J1	J2	S	s	s1	s2	W	Øz	U
CMR-1031	320	385	75	350	250	100	92,5	285	315	9	-
CMR-1135	350	425	95	390	280	100	107,5	315	355	9	-
CMR-1240	395	480	70	440	315	100	77,5	355	400	11	-
CMR-1445	445	540	99	498	355	100	102,5	403	450	11	-
CMR-1650	490	590	88	550	400	125	100	450	500	11	-
CMR-1856	550	660	55	610	450	125	125	500	560	13	-
CMR-2063	620	750	95	690	500	125	92,5	560	630	13	-
CMR-2271	690	840	75	775	560	125	62,5	625	710	13	-
CMR-2380	680	920	160	871	560	200	140	639	800	14	-

Positions

LG 270 standard supply
 Models 2380, 2590 and 28100 fixed positions LG 270 (other positions on request only)





EFFICIENT WORK



Erp. Characteristic curves and ErP data

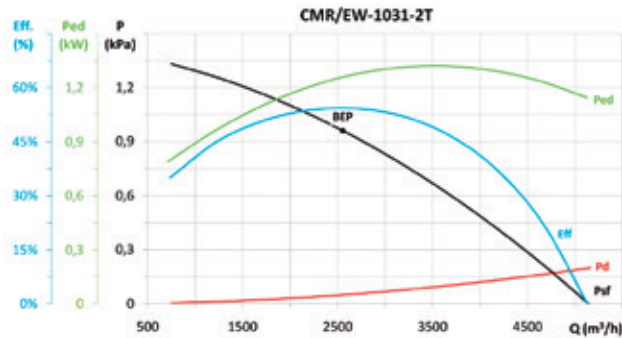

MC	EC	SR	Cc	η_e [%]*	N	[kW]	[m³/h]	[Pa]	[rpm]	VSD
A	S	1,01	1,08	58,8%	68,2	1,254	2553	961,3	2916	NECESSARY

* η_e (%) = Eff. (%) x Cc

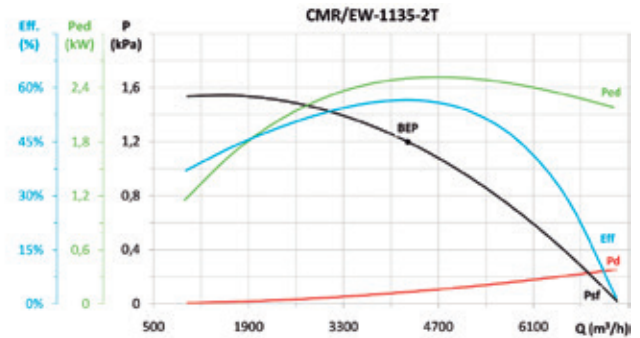

MC	EC	SR	Cc	η_e [%]*	N	[kW]	[m³/h]	[Pa]	[rpm]	VSD
A	S	1,01	1,06	60,0%	66,3	2,500	4249	1198,6	2916	NECESSARY

* η_e (%) = Eff. (%) x Cc

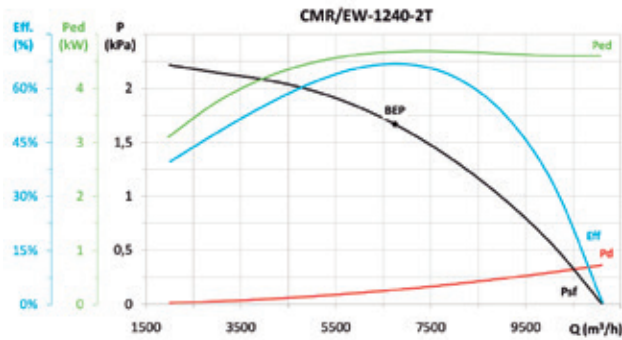

MC	EC	SR	Cc	η_e [%]*	N	[kW]	[m³/h]	[Pa]	[rpm]	VSD
A	S	1,02	1,04	69,6%	73,1	4,675	6744	1667,2	2901	NECESSARY

* η_e (%) = Eff. (%) x Cc

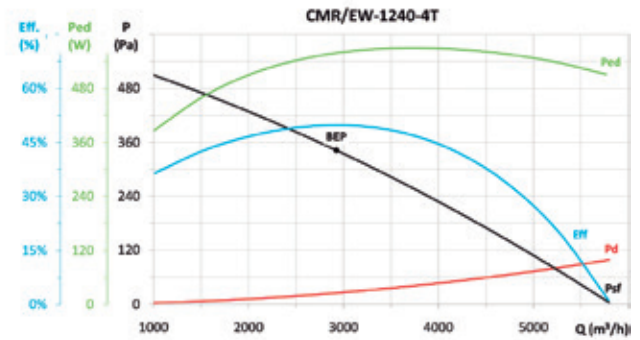

MC	EC	SR	Cc	η_e [%]*	N	[kW]	[m³/h]	[Pa]	[rpm]	VSD
A	S	1,00	1,11	55,1%	68,2	0,558	2924	342,3	1453	NECESSARY

* η_e (%) = Eff. (%) x Cc

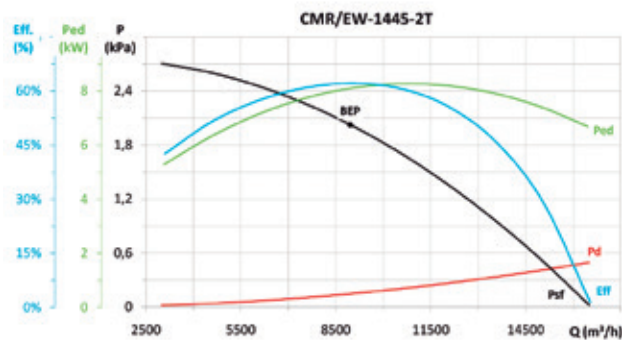

MC	EC	SR	Cc	η_e [%]*	N	[kW]	[m³/h]	[Pa]	[rpm]	VSD
A	S	1,02	1,04	64,6%	65,6	8,103	8951	2025,7	2939	NECESSARY

* η_e (%) = Eff. (%) x Cc

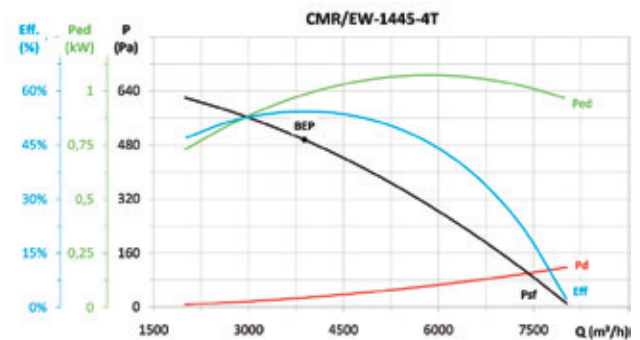

MC	EC	SR	Cc	η_e [%]*	N	[kW]	[m³/h]	[Pa]	[rpm]	VSD
A	S	1,01	1,09	59,1%	69,7	0,983	3883	495,3	1468	NECESSARY

* η_e (%) = Eff. (%) x Cc

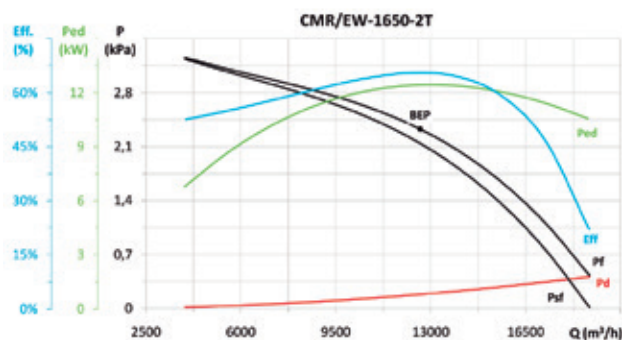

MC	EC	SR	Cc	η_e [%]*	N	[kW]	[m³/h]	[Pa]	[rpm]	VSD
B	T	1,02	1,04	68,2%	68,0	12,431	12602	2328,0	2927	NECESSARY

* η_e (%) = Eff. (%) x Cc

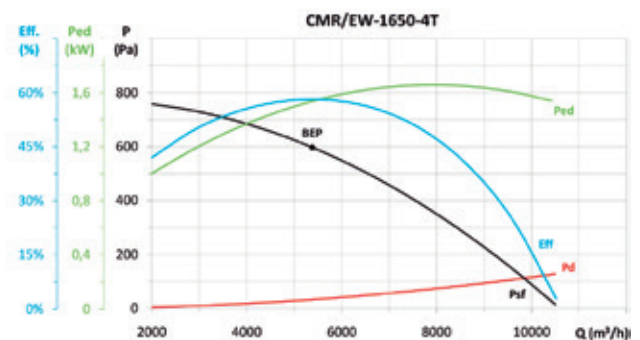

MC	EC	SR	Cc	η_e [%]*	N	[kW]	[m³/h]	[Pa]	[rpm]	VSD
A	S	1,01	1,08	62,5%	71,1	1,535	5378	597,4	1449	NECESSARY

* η_e (%) = Eff. (%) x Cc



Erp. Characteristic curves and ErP data

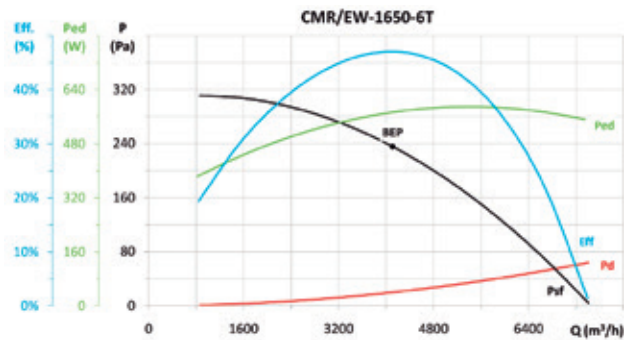

MC	EC	SR	Cc	η_e (%)*	N	[kW]	[m³/h]	[Pa]	[rpm]	VSD
A	S	1,00	1,10	52,0%	65,0	0,572	4109	235,7	966	NECESSARY

* η_e (%) = Eff. (%) x Cc

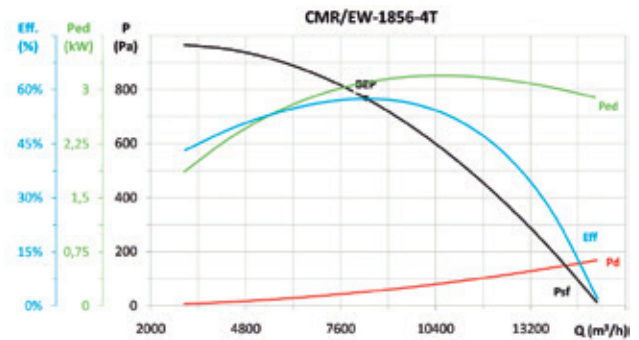

MC	EC	SR	Cc	η_e (%)*	N	[kW]	[m³/h]	[Pa]	[rpm]	VSD
A	S	1,01	1,05	60,6%	65,9	3,096	8342	768,0	1448	NECESSARY

* η_e (%) = Eff. (%) x Cc

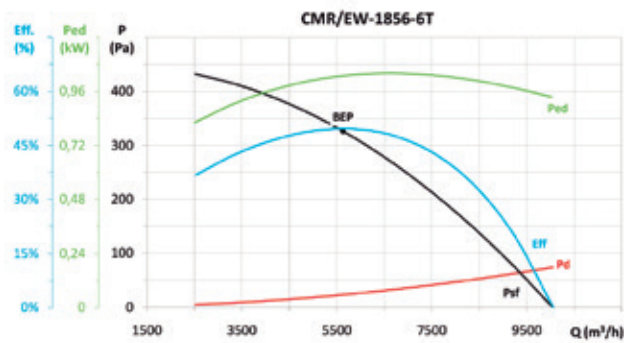

MC	EC	SR	Cc	η_e (%)*	N	[kW]	[m³/h]	[Pa]	[rpm]	VSD
A	S	1,00	1,09	53,9%	64,3	1,028	5632	326,1	960	NECESSARY

* η_e (%) = Eff. (%) x Cc

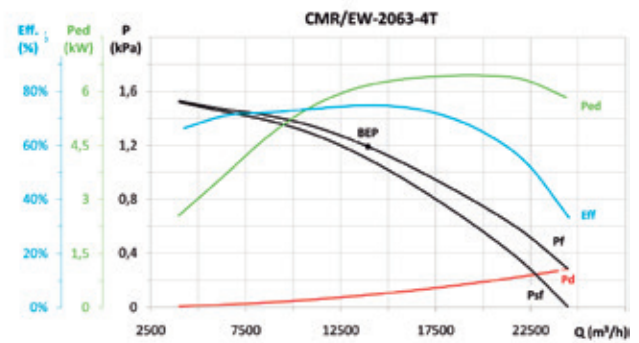

MC	EC	SR	Cc	η_e (%)*	N	[kW]	[m³/h]	[Pa]	[rpm]	VSD
B	T	1,01	1,04	77,8%	80,0	6,161	13932	1190,7	1466	NECESSARY

* η_e (%) = Eff. (%) x Cc

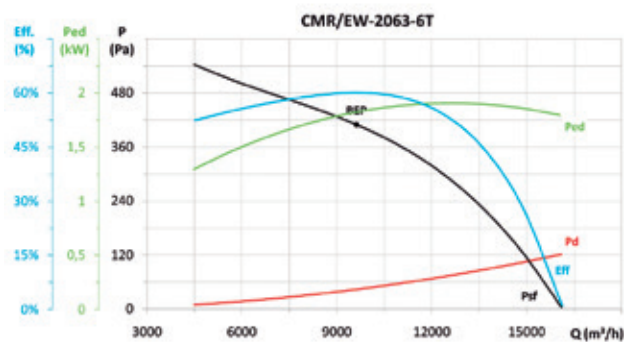

MC	EC	SR	Cc	η_e (%)*	N	[kW]	[m³/h]	[Pa]	[rpm]	VSD
A	S	1,00	1,07	64,3%	72,1	1,822	9620	409,7	952	NECESSARY

* η_e (%) = Eff. (%) x Cc

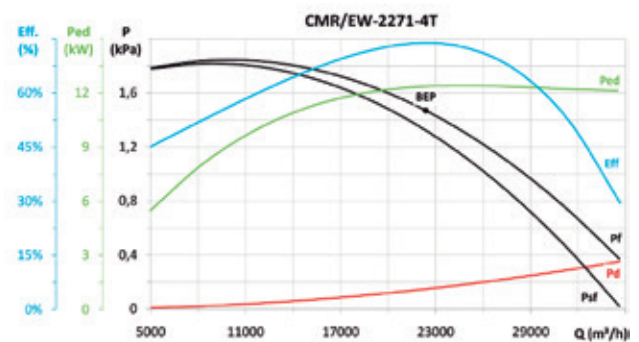

MC	EC	SR	Cc	η_e (%)*	N	[kW]	[m³/h]	[Pa]	[rpm]	VSD
B	T	1,01	1,04	76,8%	76,7	12,369	22380	1469,6	1470	NECESSARY

* η_e (%) = Eff. (%) x Cc

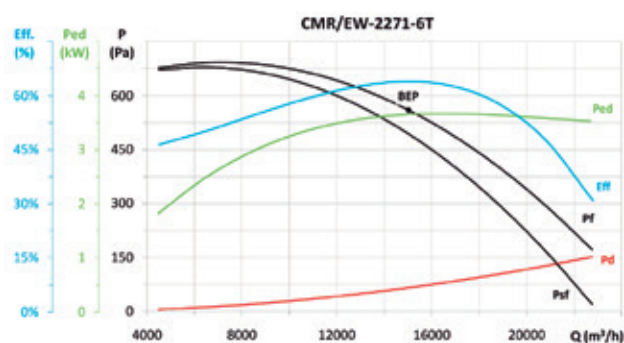

MC	EC	SR	Cc	η_e (%)*	N	[kW]	[m³/h]	[Pa]	[rpm]	VSD
B	T	1,01	1,05	67,1%	71,7	3,654	15016	560,2	970	NECESSARY

* η_e (%) = Eff. (%) x Cc

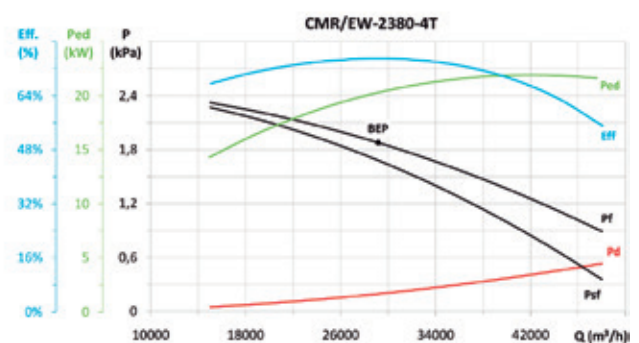

MC	EC	SR	Cc	η_e (%)*	N	[kW]	[m³/h]	[Pa]	[rpm]	VSD
B	T	1,02	1,04	78,0%	77,3	20,266	29151	1877,3	1480	NECESSARY

* η_e (%) = Eff. (%) x Cc



EFFICIENT WORK



Erp. Characteristic curves and ErP data

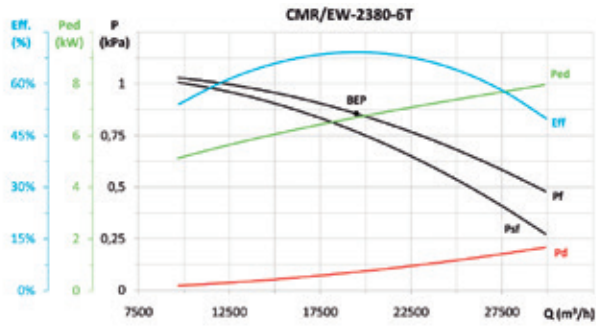

MC	EC	SR	Cc	η_r (%)*	N	[kW]	[m^3/h]	[Pa]	[rpm]	VSD
B	T	1,01	1,04	72,0%	73,8	6,696	19494	855,7	977	NECESSARY

* η_e (%) = Eff. (%) x Cc

Accessories

See accessories section.

