

CJTHT/PLUS

400 °C/2h and 300 °C/2h axial exhaust fan units with built-in acoustic attenuator



Extraction units with axial fans to work immersed in fire risk areas.

Fan:

- Fan with tubular sheet steel casing.
- Galvanised sheet steel structure with thermal insulation and acoustic insulation.
- Variable angle impeller made of cast aluminium.
- Approved in accordance with standard EN 12101-3, with certifications no.: 0370- CPR-0312 (F400) and 0370-CPR-0974 (F300).

Motor:

- Class H motors for S1 continuous operation and S2 emergency use. With ball bearings, IP55 protection and 1 or 2 speeds, depending on model.
- Motors with IE3 efficiency for powers equal to or greater than 0.75 kW, except single-phase, 2-speed and 8-pole.
- Three-phase 230/400 V 50 Hz (up to 3 kW) and 400/690 V 50 Hz (powers greater than 3 kW).

- Maximum temperature of air to be carried: S1 -20 °C +40 °C continuous service, also suitable for warm climates with temperatures up to 50 °C. S2 operation, 300 °C/2h, 400 °C/2h.

Finish:

- Fan: anti-corrosive in polyester resin polymerized at 190 °C, after degreasing with phosphate-free nanotechnological treatment.
- Box: anti-corrosive in galvanised sheet steel.

Available versions:

- CJTHT: axial fans with acoustically insulated boxes.
- CJTHT/ATEX: axial fans with acoustically insulated boxes and ATEX certification, category 3 Ex II3G for zone 2 (only 400 °C/2h and 300 °C/2h).
- CJTHT/PLUS Axial fans with acoustic attenuators.

On request:

- Airflow direction from impeller to motor.
- 100% reversible impellers.

Order code

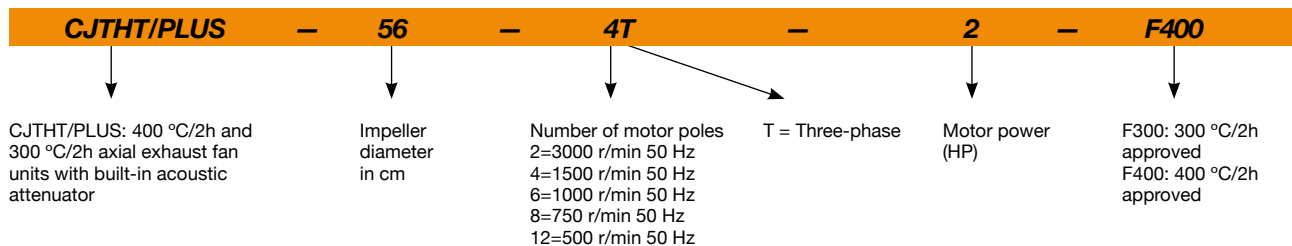

Technical characteristics

Model	Speed (r/min)	Maximum admissible current (A)			Installed power (kW)	Blade tilt angle (°)	Maximum flow rate (m³/h)	Sound pressure level ¹ dB (A)	Approx. weight (Kg)
		230V	400V	690V					
CJTHT/PLUS-40-2/4T-1.5	2900 / 1435	2.89 / 1.04			1.10 / 0.25	20	7040 / 3480	71 / 56	53
CJTHT/PLUS-40-4T-0.75	1420	2.84	1.64		0.55	32	4800	55	47
CJTHT/PLUS-40-6T-0.75	930	2.90	1.75		0.55	32	3150	46	52
CJTHT/PLUS-40-6/12T-0.75	940 / 455	2.35 / 1.15			0.60 / 0.15	32	3150 / 1520	46 / 31	56
CJTHT/PLUS-45-2/4T-2	2940 / 1465	3.58 / 1.19			1.50 / 0.37	16	9400 / 4680	71 / 56	56
CJTHT/PLUS-45-4T-0.75	1420	2.84	1.64		0.55	36	7450	58	49
CJTHT/PLUS-45-6T-0.75	930	2.90	1.75		0.55	30	4450	48	53
CJTHT/PLUS-45-6/12T-0.75	940 / 455	2.35 / 1.15			0.60 / 0.15	30	4450 / 2150	48 / 33	58
CJTHT/PLUS-50-4T-0.75	1420	2.84	1.64		0.55	22	8392	60	50

Technical characteristics

Model	Speed (r/min)	Maximum admissible current (A)			Installed power (kW)	Blade tilt angle (°)	Maximum flow rate (m ³ /h)	Sound pressure level ¹ dB (A) Inlet	Approx. weight (Kg)
		230V	400V	690V					
CJTHT/PLUS-50-6T-0.75	930	2.90	1.75		0.55	32	7000	52	55
CJTHT/PLUS-56-4T-1 IE3	1430	3.08	1.79		0.75	22	11250	63	62
CJTHT/PLUS-56-4T-1.5 IE3	1420	4.10	2.37		1.10	30	13600	63	64
CJTHT/PLUS-56-4/8T-1.5	1440 / 705		2.69 / 1.12		1.10 / 0.25	30	13600 / 6640	63 / 48	68
CJTHT/PLUS-56-4T-2 IE3	1425	5.89	3.38		1.50	36	15030	64	68
CJTHT/PLUS-56-6T-0.75	930	2.90	1.75		0.55	38	10140	54	64
CJTHT/PLUS-56-6/12T-0.75	940 / 455		2.35 / 1.15		0.60 / 0.15	38	10140 / 4890	54 / 39	68
CJTHT/PLUS-63-4T-1 IE3	1430	3.08	1.79		0.75	14	15190	67	66
CJTHT/PLUS-63-4T-1.5 IE3	1420	4.10	2.37		1.10	20	17800	66	69
CJTHT/PLUS-63-4/8T-1.5	1440 / 705		2.69 / 1.12		1.10 / 0.25	20	17800 / 8680	66 / 51	72
CJTHT/PLUS-63-4T-2 IE3	1425	5.89	3.38		1.50	24	19280	66	72
CJTHT/PLUS-63-4/8T-2	1415 / 715		3.40 / 1.65		1.50 / 0.30	24	19280 / 9740	66 / 52	84
CJTHT/PLUS-63-4T-3 IE3	1435	7.86	4.52		2.20	32	22150	68	78
CJTHT/PLUS-63-4/8T-3	1415 / 700		4.80 / 1.85		2.20 / 0.45	32	22150 / 10920	68 / 53	90
CJTHT/PLUS-63-4T-4 IE3	1430	11.01	6.33		3.00	38	24240	69	87
CJTHT/PLUS-63-4/8T-4	1420 / 710		6.45 / 2.28		3.00 / 0.60	38	24240 / 12070	69 / 54	101
CJTHT/PLUS-63-6T-0.75	930	2.90	1.75		0.55	28	13590	57	68
CJTHT/PLUS-63-6/12T-0.75	940 / 455		2.35 / 1.15		0.60 / 0.15	28	13590 / 6550	57 / 42	72
CJTHT/PLUS-63-6T-1 IE3	940	3.36	1.93		0.75	38	15890	58	72
CJTHT/PLUS-63-6/12T-1	935 / 455		3.75 / 2.76		0.80 / 0.20	38	15890 / 7700	58 / 43	78
CJTHT/PLUS-71-4T-1.5 IE3	1420	4.10	2.37		1.10	12	19480	71	85
CJTHT/PLUS-71-4/8T-1.5	1440 / 705		2.69 / 1.12		1.10 / 0.25	12	19480 / 9500	71 / 56	89
CJTHT/PLUS-71-4T-2 IE3	1425	5.89	3.38		1.50	14	20900	70	89
CJTHT/PLUS-71-4/8T-2	1415 / 715		3.40 / 1.65		1.50 / 0.30	14	20900 / 10560	70 / 56	101
CJTHT/PLUS-71-4T-3 IE3	1435	7.86	4.52		2.20	22	25100	70	95
CJTHT/PLUS-71-4/8T-3	1415 / 700		4.80 / 1.85		2.20 / 0.45	22	25100 / 12370	70 / 55	107
CJTHT/PLUS-71-4T-4 IE3	1430	11.01	6.33		3.00	28	27480	70	104
CJTHT/PLUS-71-4/8T-4	1420 / 710		6.45 / 2.28		3.00 / 0.60	28	27480 / 13680	70 / 55	118
CJTHT/PLUS-71-6T-0.75	930	2.90	1.75		0.55	20	16100	60	85
CJTHT/PLUS-71-6/12T-0.75	940 / 455		2.35 / 1.15		0.60 / 0.15	20	16100 / 7760	60 / 45	89
CJTHT/PLUS-71-6T-1 IE3	940	3.36	1.93		0.75	26	17300	60	88
CJTHT/PLUS-71-6/12T-1	935 / 455		3.75 / 2.76		0.80 / 0.20	26	17300 / 8380	60 / 45	95
CJTHT/PLUS-71-6T-1.5 IE3	945	4.73	2.72		1.10	34	19930	61	94
CJTHT/PLUS-71-6/12T-1.5	940 / 460		3.52 / 2.00		1.20 / 0.30	34	19930 / 9760	61 / 46	102
CJTHT/PLUS-80-4T-3 IE3	1435	7.86	4.52		2.20	12	25450	75	103
CJTHT/PLUS-80-4/8T-3	1415 / 700		4.80 / 1.85		2.20 / 0.45	12	25450 / 12550	75 / 60	115
CJTHT/PLUS-80-4T-4 IE3	1430	11.01	6.33		3.00	16	30250	74	112
CJTHT/PLUS-80-4/8T-4	1420 / 710		6.45 / 2.28		3.00 / 0.60	16	30250 / 15060	74 / 59	125
CJTHT/PLUS-80-4T-5.5 IE3	1440		7.95	4.61	4.00	18	32750	73	118
CJTHT/PLUS-80-4/8T-5.5	1450 / 715		7.88 / 2.87		3.80 / 1.00	18	32750 / 16150	73 / 58	153
CJTHT/PLUS-80-6T-1.5 IE3	945	4.73	2.72		1.10	18	21450	63	102
CJTHT/PLUS-80-6/12T-1.5	940 / 460		3.52 / 2.00		1.20 / 0.30	18	21450 / 10500	63 / 48	110
CJTHT/PLUS-80-6T-2 IE3	945	6.25	3.62		1.50	26	25950	64	111
CJTHT/PLUS-80-6/12T-2	960 / 470		4.46 / 3.43		1.60 / 0.40	26	25950 / 12700	64 / 49	115
CJTHT/PLUS-80-6T-3 IE3	950	9.78	5.62		2.20	32	29930	65	118
CJTHT/PLUS-80-6/12T-3	940 / 475		5.62 / 3.32		2.20 / 0.55	32	29930 / 15120	65 / 51	124
CJTHT/PLUS-80-8T-0.75	700	3.48	2.00		0.55	20	17540	57	95
CJTHT/PLUS-80-8T-1	710	5.06	2.92		0.75	28	20650	58	102
CJTHT/PLUS-90-4T-4 IE3	1430	11.01	6.33		3.00	8	33580	79	136
CJTHT/PLUS-90-4/8T-4	1420 / 710		6.45 / 2.28		3.00 / 0.60	8	33580 / 16720	79 / 64	149
CJTHT/PLUS-90-4T-5.5 IE3	1440		7.95	4.61	4.00	12	38890	78	142
CJTHT/PLUS-90-4/8T-5.5	1450 / 715		7.88 / 2.87		3.80 / 1.00	12	38890 / 19170	78 / 63	177
CJTHT/PLUS-90-4T-7.5 IE3	1430		10.40	6.04	5.50	18	46140	77	168
CJTHT/PLUS-90-4/8T-7.5	1455 / 725		11.40 / 3.86		5.50 / 1.10	18	46140 / 22910	77 / 62	182
CJTHT/PLUS-90-4T-10 IE3	1460		14.20	8.17	7.50	22	50140	76	179

Technical characteristics

Model	Speed (r/min)	Maximum admissible current (A)			Installed power (kW)	Blade tilt angle (°)	Maximum flow rate (m³/h)	Sound pressure level¹ dB (A) Inlet	Approx. weight (Kg)
		230V	400V	690V					
CJTHT/PLUS-90-4/8T-10	1455 / 725		15.10 / 5.16		7.50 / 1.50	22	50140 / 24900	76 / 61	182
CJTHT/PLUS-90-6T-2 IE3	945	6.25	3.62		1.50	16	28780	66	135
CJTHT/PLUS-90-6/12T-2	960 / 470		4.46 / 3.43		1.60 / 0.40	16	28780 / 14090	66 / 51	139
CJTHT/PLUS-90-6T-3 IE3	950	9.78	5.62		2.20	24	34000	66	142
CJTHT/PLUS-90-6/12T-3	940 / 475		5.62 / 3.32		2.20 / 0.55	24	34000 / 17180	66 / 52	148
CJTHT/PLUS-90-6T-4 IE3	945	12.80	6.36		3.00	30	38900	69	166
CJTHT/PLUS-90-6/12T-4	970 / 485		7.37 / 3.53		2.80 / 0.70	30	38900 / 19450	69 / 54	168
CJTHT/PLUS-90-8T-1	710	5.06	2.92		0.75	18	22900	60	126
CJTHT/PLUS-90-8T-2	700	7.32	4.21		1.50	30	29490	63	142
CJTHT/PLUS-90-8T-3	705	9.30	5.35		2.20	32	30850	64	158
CJTHT/PLUS-100-4T-7.5 IE3	1430		10.40	6.04	5.50	10	46850	82	176
CJTHT/PLUS-100-4/8T-7.5	1455 / 725		11.40 / 3.86		5.50 / 1.10	10	46850 / 23260	82 / 67	190
CJTHT/PLUS-100-4T-10 IE3	1460		14.20	8.17	7.50	16	57400	79	187
CJTHT/PLUS-100-4/8T-10	1455 / 725		15.10 / 5.16		7.50 / 1.50	14	54710 / 27170	80 / 65	190
CJTHT/PLUS-100-4T-15 IE3	1455		20.70	11.99	11.00	22	66300	79	231
CJTHT/PLUS-100-4/8T-15	1470 / 730		20.70 / 7.19		11.00 / 3.00	22	66300 / 32880	79 / 64	231
CJTHT/PLUS-100-4T-20 IE3	1460		27.80	16.03	15.00	28	76150	80	246
CJTHT/PLUS-100-4/8T-20	1470 / 725		31.72 / 11.75		15.00 / 3.80	28	76150 / 37560	80 / 65	246
CJTHT/PLUS-100-4T/9-15 IE3	1460		20.70	11.99	11.00	18	55340	80	231
CJTHT/PLUS-100-4T/9-20 IE3	1460		27.80	16.03	15.00	22	63260	80	240
CJTHT/PLUS-100-4T/9-25 IE3	1475		35.40	20.39	18.50	26	70625	80	280
CJTHT/PLUS-100-4T/9-30 IE3	1475		42.20	24.44	22.00	30	74845	82	288
CJTHT/PLUS-100-6T-3 IE3	950	9.78	5.62		2.20	16	37600	70	150
CJTHT/PLUS-100-6/12T-3	940 / 475		5.62 / 3.32		2.20 / 0.55	16	37600 / 18990	70 / 56	156
CJTHT/PLUS-100-6T-4 IE3	945	12.80	6.36		3.00	20	41150	69	175
CJTHT/PLUS-100-6/12T-4	970 / 485		7.37 / 3.53		2.80 / 0.70	20	41150 / 20580	69 / 54	176
CJTHT/PLUS-100-6T-5.5 IE3	970		8.37	4.82	4.00	26	47780	70	187
CJTHT/PLUS-100-6T/9-5.5 IE3	970		11.00	6.35	4.00	20	39020	70	201
CJTHT/PLUS-100-6T/9-7.5 IE3	970		12.30	7.07	5.50	26	46765	71	205
CJTHT/PLUS-100-6T/9-10 IE3	970		15.20	8.83	7.50	34	52255	74	230

1 The noise level values are pressures in dB(A) measured at a distance of 3 metres in a free field.



Erp. (Energy Related Products)

Information on Directive 2009/125/EC can be downloaded from the SODECA website or the QuickFan selector programme.

Acoustic characteristics

Sound power spectrum Lw(A) in dB(A) per Hz frequency band
Values measured at inlet with maximum flow rate

	63	125	250	500	1000	2000	4000	8000		63	125	250	500	1000	2000	4000	8000
40-2-1.5	47	63	75	83	88	86	82	75	56-4-1.5	51	63	72	78	78	78	72	64
40-4-1.5 (2V)	32	48	60	68	73	71	67	60	56-8-1.5 (2V)	35	47	56	62	62	62	56	48
40-4-0.75	37	53	63	70	71	68	67	68	56-4-2	52	64	73	79	79	79	73	65
40-6-0.75	28	44	54	61	62	59	58	59	56-6-0.75	45	55	65	69	70	68	61	53
40-12-0.75 (2V)	12	28	38	45	46	43	42	43	56-12-0.75 (2V)	29	39	49	53	54	52	45	37
45-2-2	47	60	74	86	87	86	82	74	63-4-1	48	64	76	82	84	81	74	66
45-4-2 (2V)	32	45	59	71	72	71	67	59	63-4-1.5	47	63	75	81	83	80	73	65
45-4-0.75	47	59	67	73	73	73	68	60	63-8-1.5 (2V)	31	47	59	65	67	64	57	49
45-6-0.75	37	49	57	63	63	63	58	50	63-4-2	54	66	75	81	81	81	75	67
45-12-0.75 (2V)	21	33	41	47	47	47	42	34	63-8-2 (2V)	39	51	60	66	66	66	60	52
50-4-0.75	49	61	69	75	75	75	70	62	63-4-3	56	68	77	83	83	83	77	69
50-6-0.75	41	53	61	67	67	67	62	54	63-8-3 (2V)	41	53	62	68	68	68	62	54
56-4-1	51	63	72	78	78	78	72	64	63-4-4	57	69	78	84	84	84	78	70

Acoustic characteristics

Sound power spectrum Lw(A) in dB(A) per Hz frequency band
Values measured at inlet with maximum flow rate

	63	125	250	500	1000	2000	4000	8000		63	125	250	500	1000	2000	4000	8000
63-8-4 (2V)	42	54	63	69	69	69	63	55	90-4-5.5	60	76	87	93	94	92	87	79
63-6-0.75	48	58	68	72	73	71	64	56	90-8-5.5 (2V)	45	61	72	78	79	77	72	64
63-12-0.75 (2V)	32	42	52	56	57	55	48	40	90-4-7.5	59	75	86	92	93	91	86	78
63-6-1	49	59	69	73	74	72	65	57	90-8-7.5 (2V)	44	60	71	77	78	76	71	63
63-12-1 (2V)	32	42	52	56	57	55	48	40	90-4-10	58	74	85	91	92	90	85	77
71-4-1.5	57	73	80	86	86	86	82	74	90-8-10 (2V)	43	59	70	76	77	75	70	62
71-8-1.5 (2V)	41	57	64	70	70	70	66	58	90-6-2	52	67	78	82	82	78	71	63
71-4-2	56	72	79	85	85	85	81	73	90-12-2 (2V)	36	51	62	66	66	62	55	47
71-8-2 (2V)	41	57	64	70	70	70	66	58	90-6-3	52	67	78	82	82	78	71	63
71-4-3	56	72	79	85	85	85	81	73	90-12-3 (2V)	37	52	63	67	67	63	56	48
71-8-3 (2V)	41	57	64	70	70	70	66	58	90-6-4	60	70	80	85	85	82	76	68
71-4-4	63	75	79	85	85	86	83	75	90-12-4 (2V)	45	55	65	70	70	67	61	53
71-8-4 (2V)	48	60	64	70	70	71	68	60	90-8-1	42	63	70	75	78	74	67	56
71-6-0.75	46	53	73	76	76	71	63	55	90-8-2	51	66	73	78	81	77	70	59
71-12-0.75 (2V)	30	37	57	60	60	55	47	39	90-8-3	53	67	74	79	82	78	71	60
71-6-1	46	64	73	76	76	71	64	55	100-4-7.5	67	83	90	97	98	96	92	84
71-12-1 (2V)	29	47	56	59	59	54	47	38	100-8-7.5 (2V)	52	68	75	82	83	81	77	69
71-6-1.5	47	65	74	77	77	72	65	56	100-4-10	65	81	88	95	96	94	90	82
71-12-1.5 (2V)	32	50	59	62	62	57	50	41	100-8-10 (2V)	50	66	73	80	81	79	75	67
80-4-3	55	71	84	91	91	88	82	74	100-4-15	71	83	87	93	94	94	91	83
80-8-3 (2V)	40	56	69	76	76	73	67	59	100-8-15 (2V)	56	68	72	78	79	79	76	68
80-4-4	54	70	83	90	90	87	81	73	100-4-20	72	84	88	94	95	95	92	84
80-8-4 (2V)	39	55	68	75	75	72	66	58	100-8-20 (2V)	57	69	73	79	80	80	77	69
80-4-5.5	53	69	82	89	89	86	80	72	100-4-9-15	65	81	88	95	96	94	90	82
80-8-5.5 (2V)	38	54	67	74	74	71	65	57	100-4-9-20	72	84	88	94	95	95	92	84
80-6-1.5	53	68	75	78	79	76	70	62	100-4-9-25	72	84	88	94	95	95	92	84
80-12-1.5 (2V)	38	53	60	63	64	61	55	47	100-4-9-30	74	86	90	96	97	97	94	86
80-6-2	59	69	75	79	80	78	73	65	100-6-3	57	72	82	85	86	83	75	67
80-12-2 (2V)	43	53	59	63	64	62	57	49	100-12-3 (2V)	42	57	67	70	71	68	60	52
80-6-3	60	70	76	80	81	79	74	66	100-6-4	56	71	81	84	85	82	74	66
80-12-3 (2V)	45	55	61	65	66	64	59	51	100-12-4 (2V)	41	56	66	69	70	67	59	51
80-8-0.75	46	59	67	72	74	71	64	53	100-6-5.5	57	72	82	85	86	83	75	67
80-8-1	47	60	68	73	75	72	65	54	100-6/9-5.5	57	72	82	85	86	83	75	67
90-4-4	61	77	88	94	95	93	88	80	100-6/9-7.5	57	72	82	85	86	83	75	67
90-8-4 (2V)	46	62	73	79	80	78	73	65	100-6/9-10	58	73	83	86	87	84	76	68

Dimensions mm

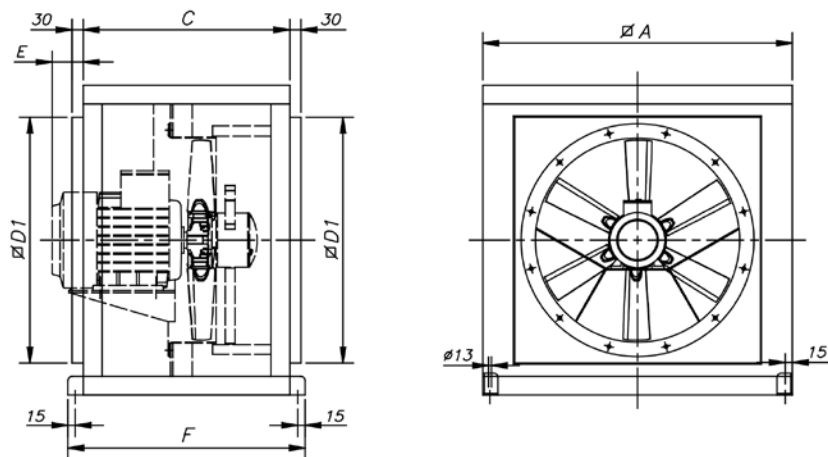

	A	C	øD1	E	F
CJTH/PLUS-40/45/50	700	550	565	-	630
CJTH/PLUS-56/63	825	550	690	140	630
CJTH/PLUS-71/80	1000	650	850	-	730
CJTH/PLUS-90/100	1200	750	1050	-	830

Accessories



Configuration with BOXPARK



Control panels for car park ventilation systems with triple purpose: daily ventilation, CO concentration control and smoke extraction in case of fire

Control panels in metal enclosure with all the necessary elements for the management and control of fans in car park ventilation systems, whether they are based on duct networks or impulse fans, for the control of CO concentration levels and smoke extraction in case of fire. Customised panels for all power ratings and number of fans according to project requirements.

More information see BOXPARK series.

Installation examples with BOXPARK

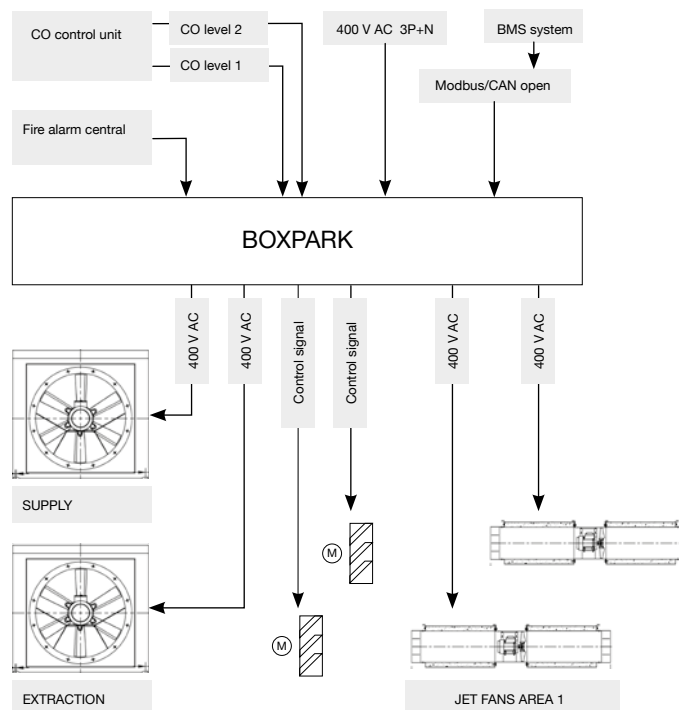

EXAMPLE OF SELECTION

Characteristic curves

Q= Flow rate in m³/h, m³/s and cfm

Pe= Static pressure in mm H₂O, Pa and inwg

Impeller diameter in cm: **71**

Number of motor poles: **6**

Number of blades: **6**

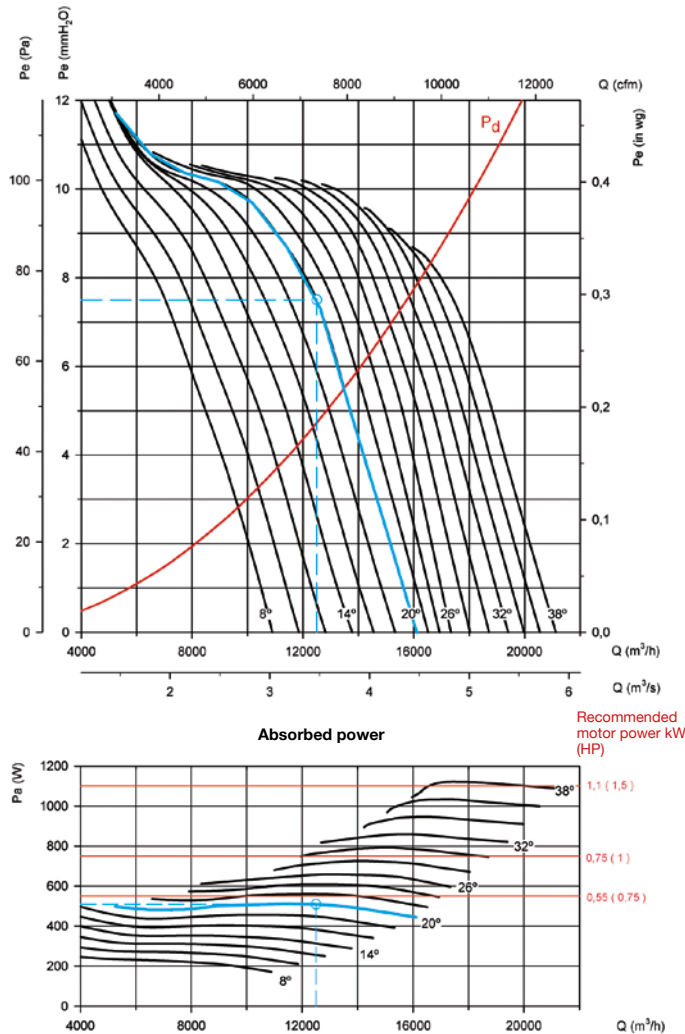

Initial data

Working point:

- Flow rate: 12,500 m³/h
- Loss of load: 7.5 mmH₂O

Steps for the selection of equipment

On the pressure graph:

- Mark the working point, defined by the airflow (12,500 m³/h) and the loss of load (7.5 mmH₂O).
- Select the curve of the equipment which is closest above the working point. In our case, a curve with a blade angle of 20° is obtained.

On the power graph:

- Mark the working point, defined by the airflow (12,500 m³/h) and the selected blade angle (20°).
- Read the absorbed power on the power axis on the left. Pa= 510 W at the working point.
- Look for the straight red line which is closest to the working point above. On the right-hand side of the graph, the value of the installed motor power is obtained. In our case, this is 0.55 kW or 0.75 HP.

EXAMPLE OF ORDER CODE

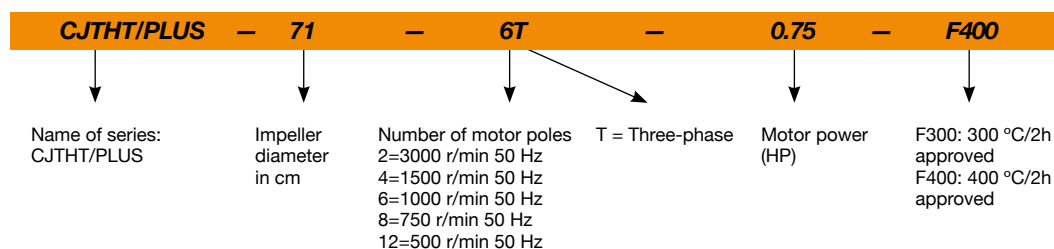

Characteristic curves

Q= Flow rate in m³/h, m³/s and cfm

Pe= Static pressure in mm H₂O, Pa and inwg

Impeller diameter in cm: 40

Number of motor poles: 2

Number of blades: 6

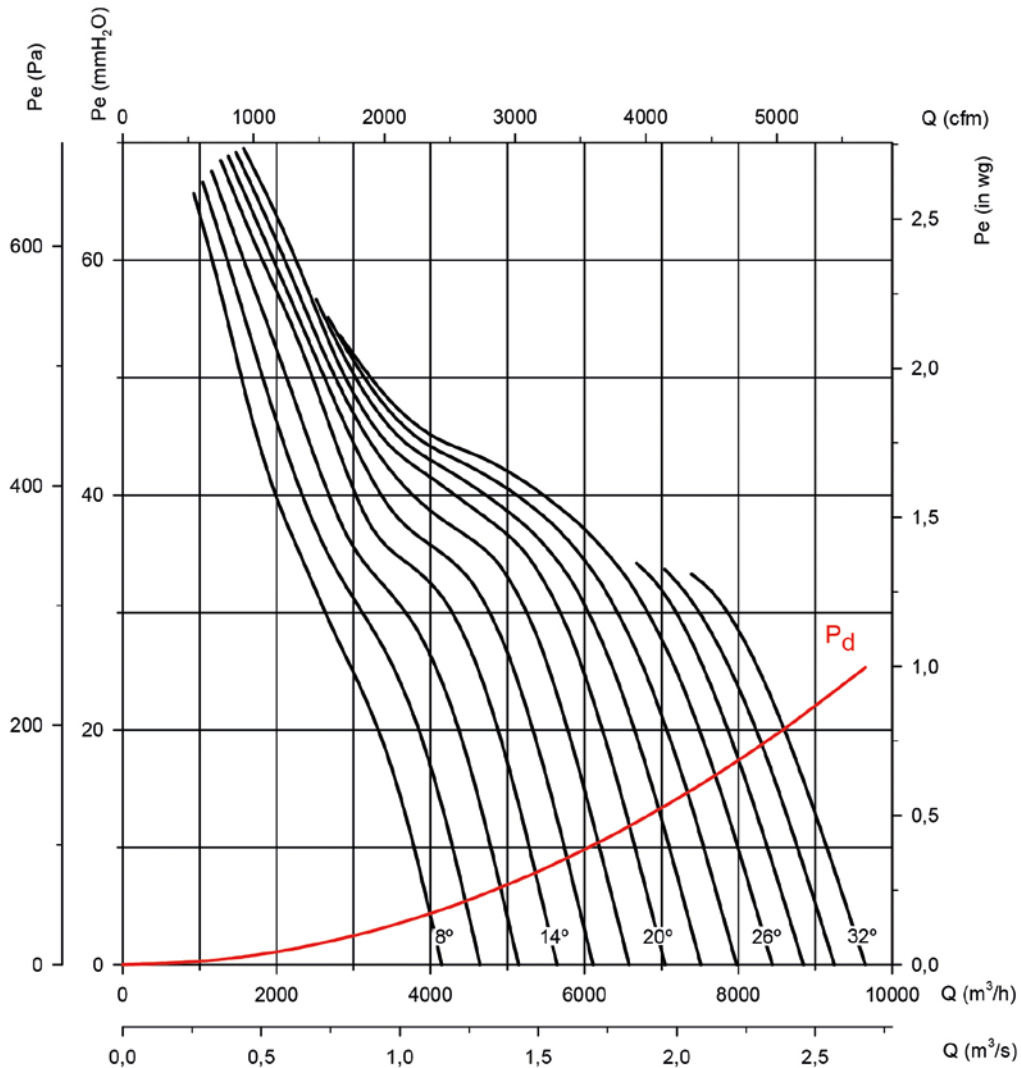

Absorbed power

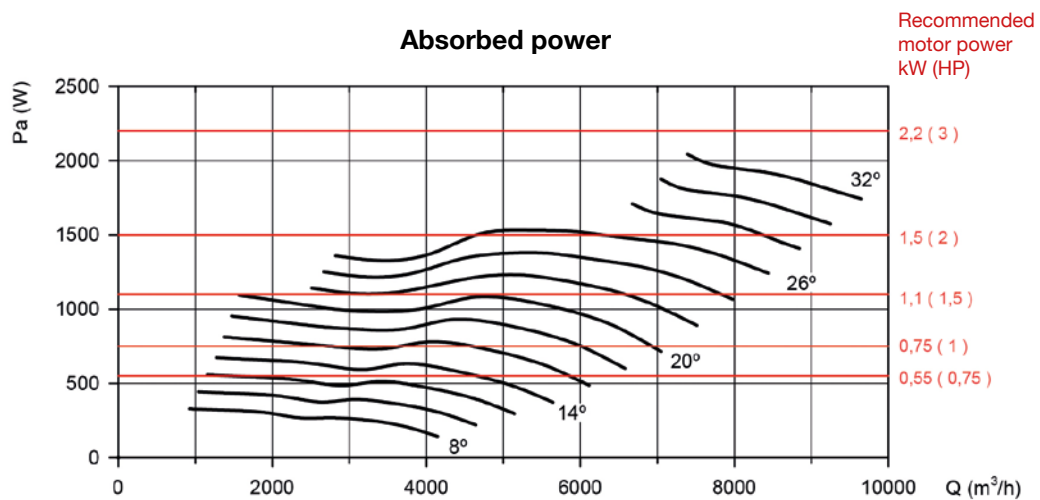

Characteristic curves

Q= Flow rate in m³/h, m³/s and cfm Pe= Static pressure in mm H₂O, Pa and inwg

Impeller diameter in cm: 40

Number of motor poles: 4

Number of blades: 6

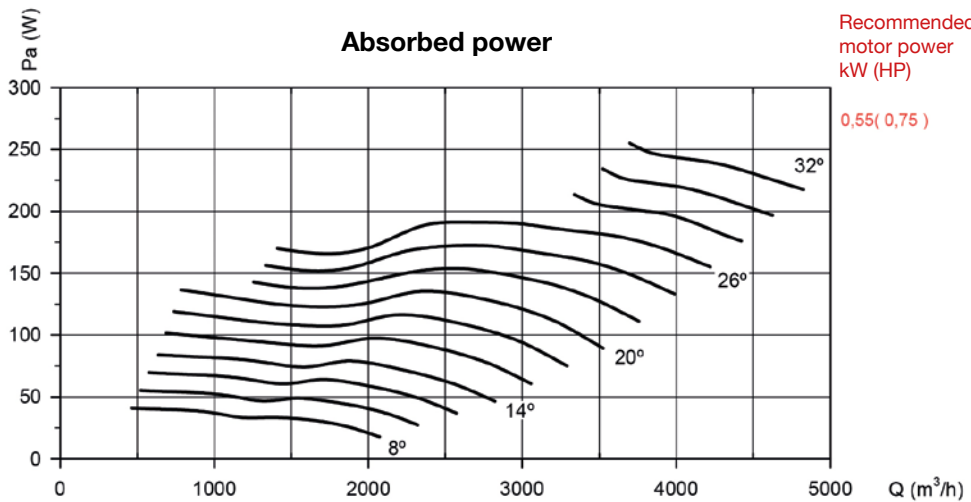
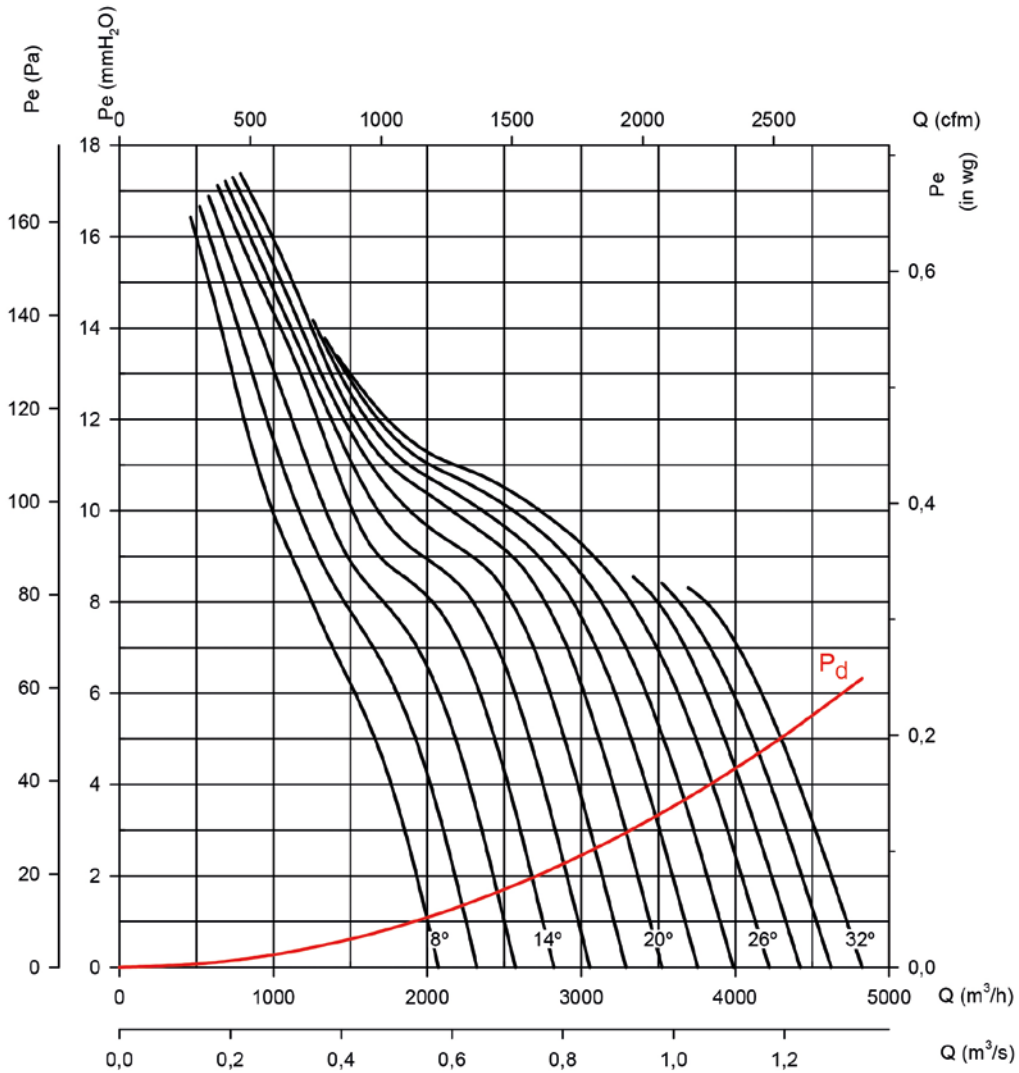

Recommended motor power kW (HP)

0,55 (0,75)

Characteristic curves

Q= Flow rate in m³/h, m³/s and cfm

Pe= Static pressure in mm H₂O, Pa and inwg

Impeller diameter in cm: 40

Number of motor poles: 6

Number of blades: 6

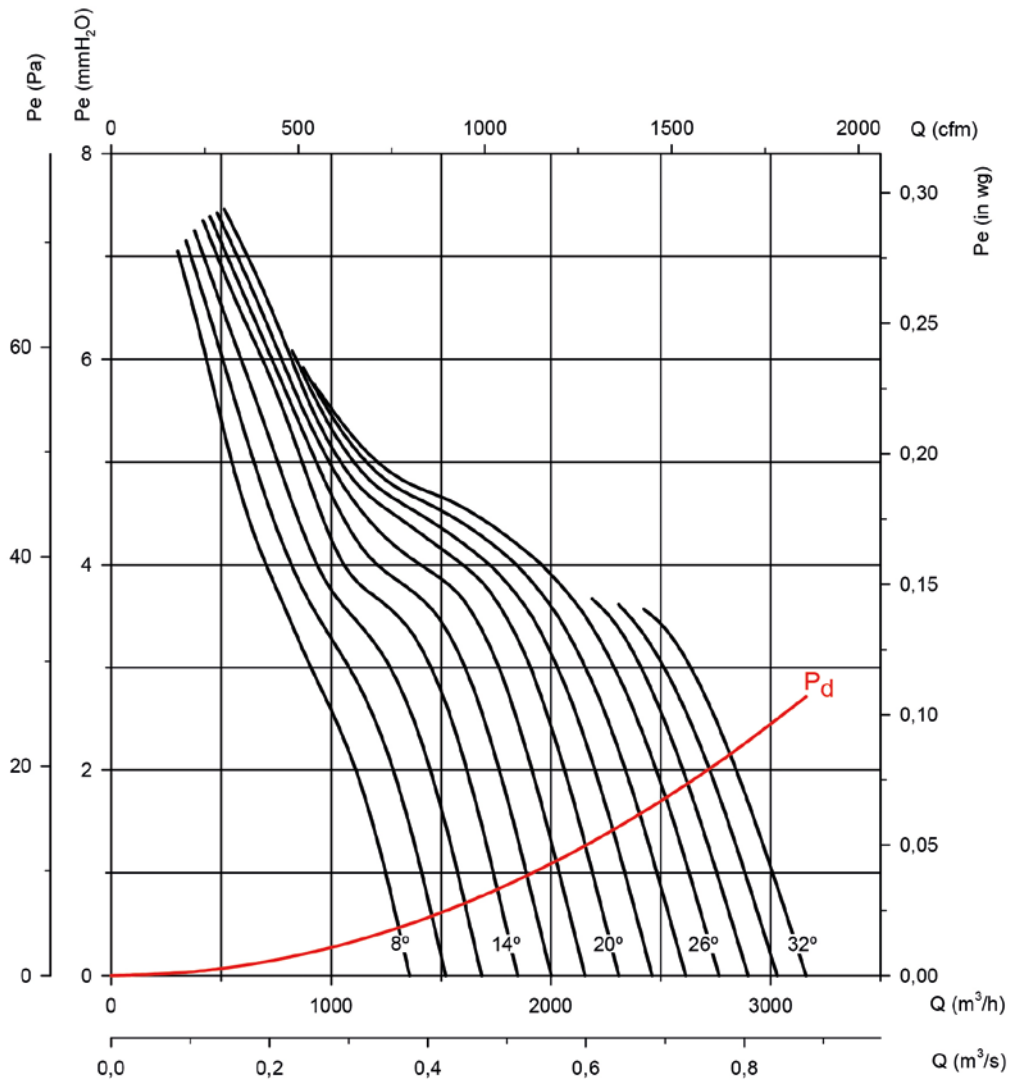

Absorbed power

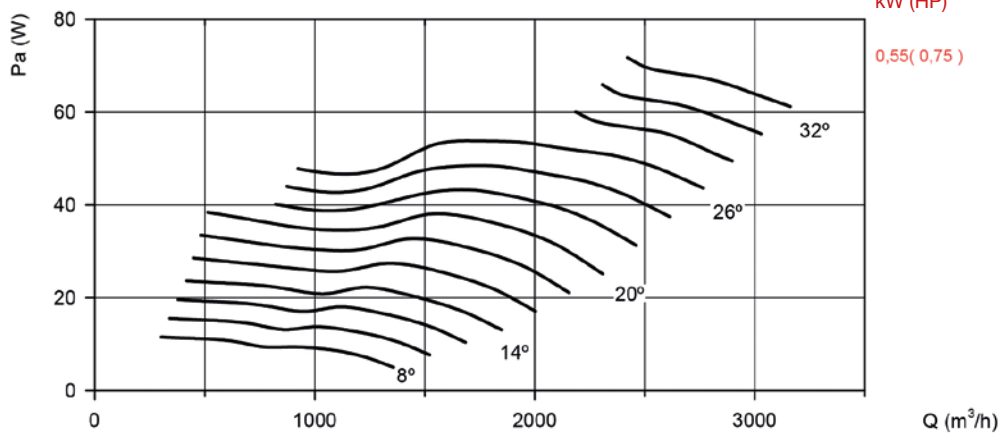

Characteristic curves

Q= Flow rate in m³/h, m³/s and cfm Pe= Static pressure in mm H₂O, Pa and inwg

Impeller diameter in cm: 45

Number of motor poles: 2

Number of blades: 6

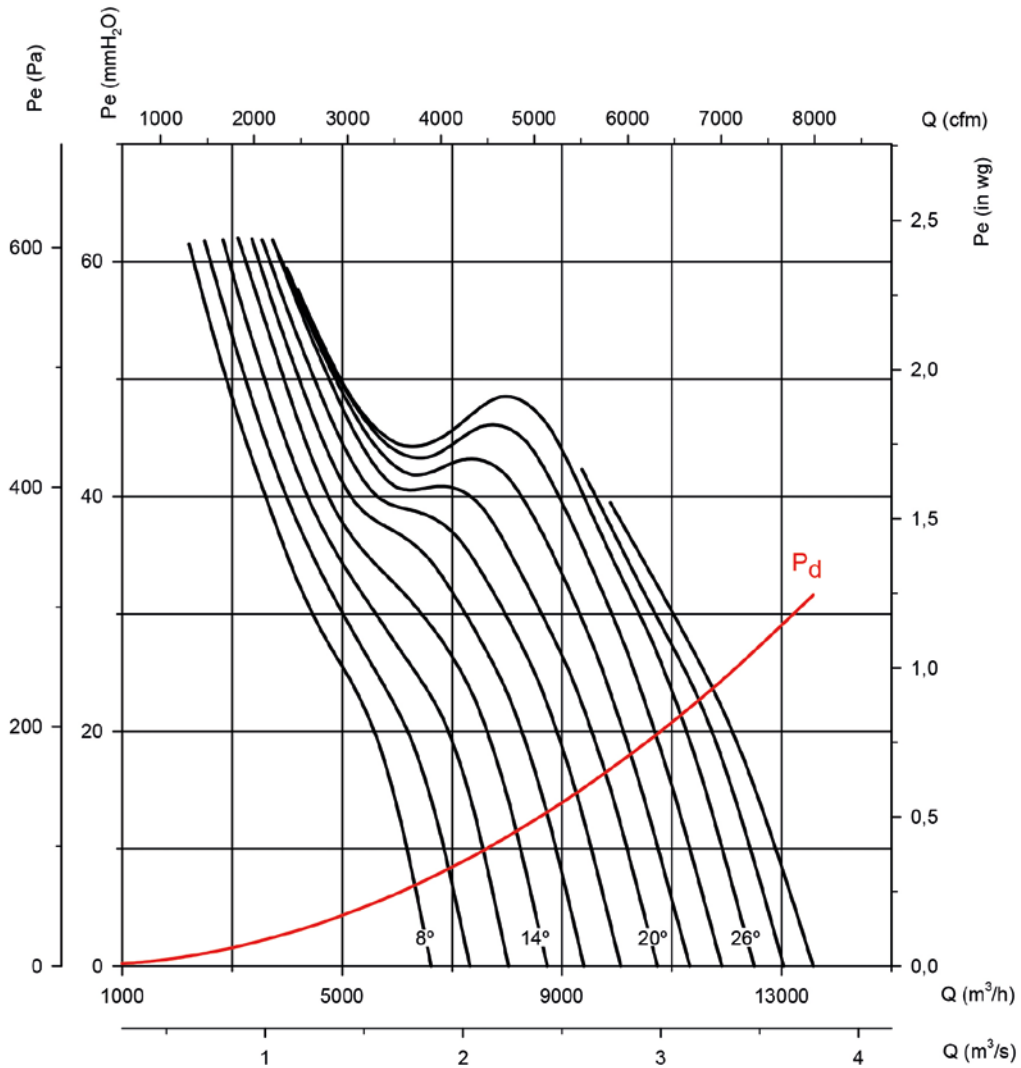

Absorbed power

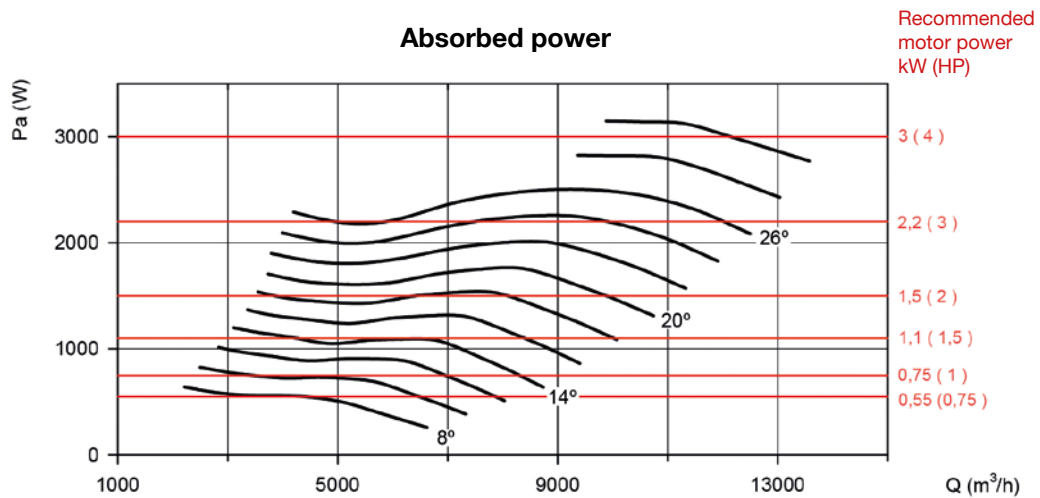

Characteristic curves

Q= Flow rate in m³/h, m³/s and cfm

Pe= Static pressure in mm H₂O, Pa and inwg

Impeller diameter in cm: 45

Number of motor poles: 4

Number of blades: 6

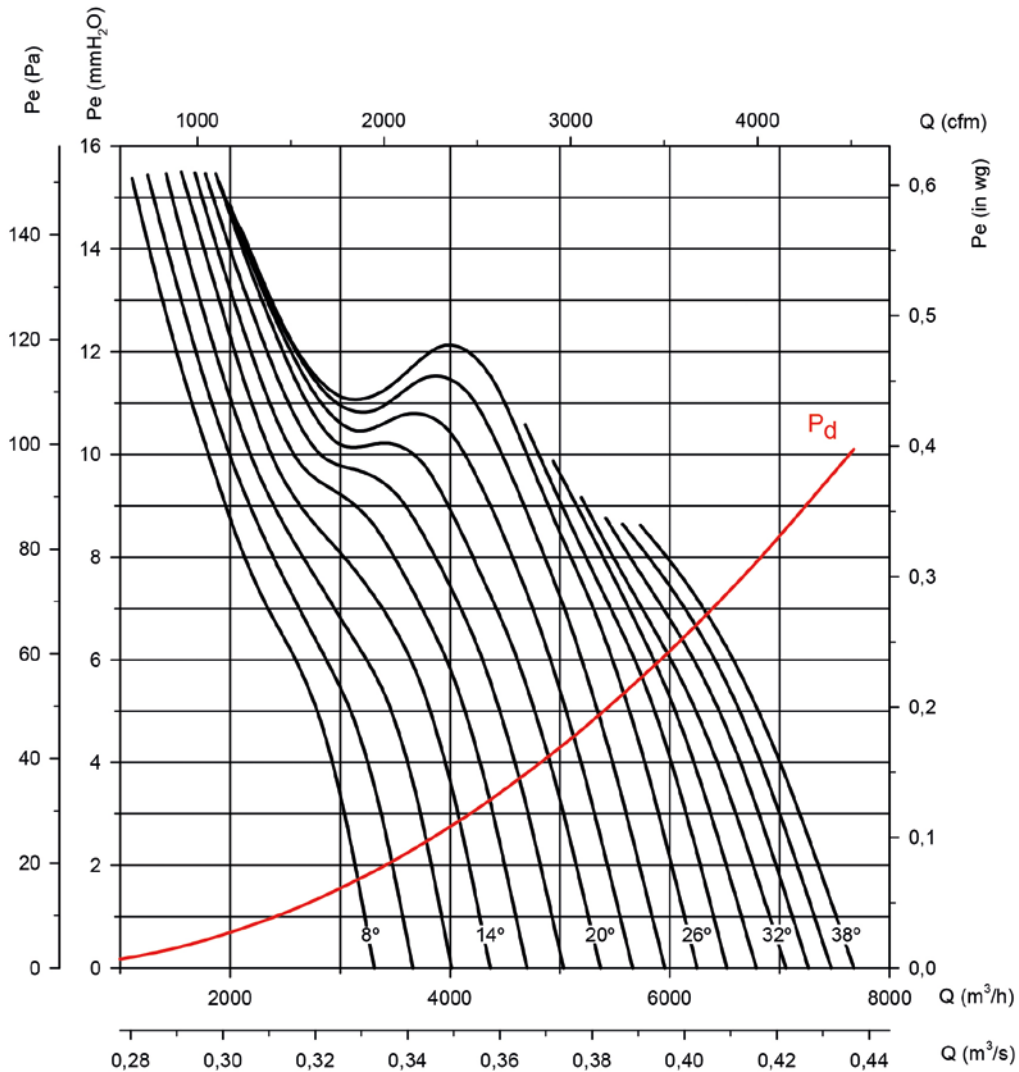

Absorbed power

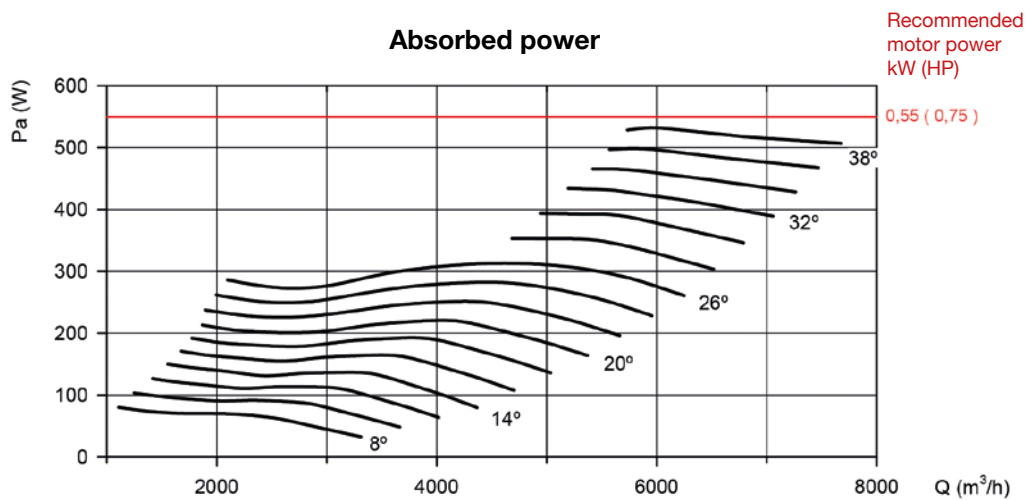

Characteristic curves

Q= Flow rate in m³/h, m³/s and cfm Pe= Static pressure in mm H₂O, Pa and inwg

Impeller diameter in cm: 45

Number of motor poles: 6

Number of blades: 6

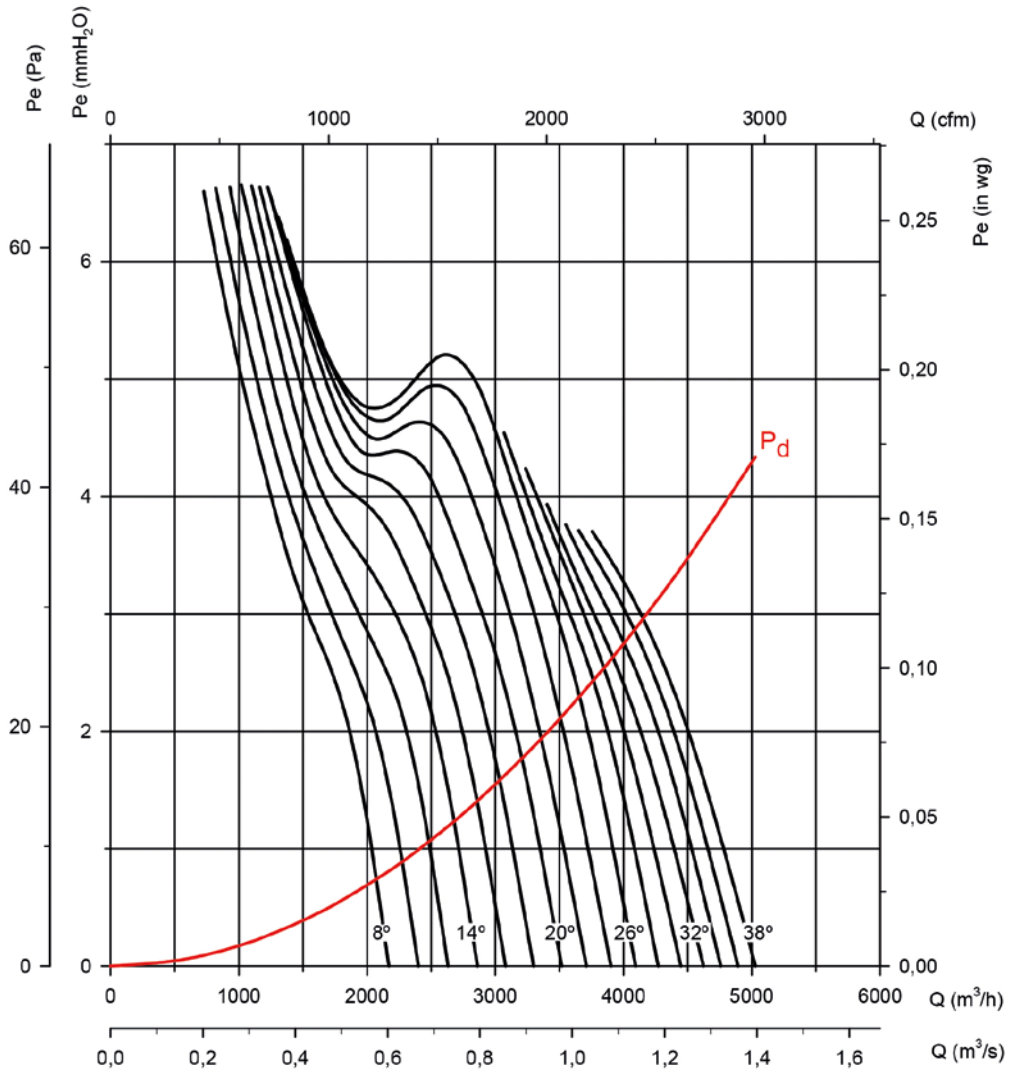

Absorbed power

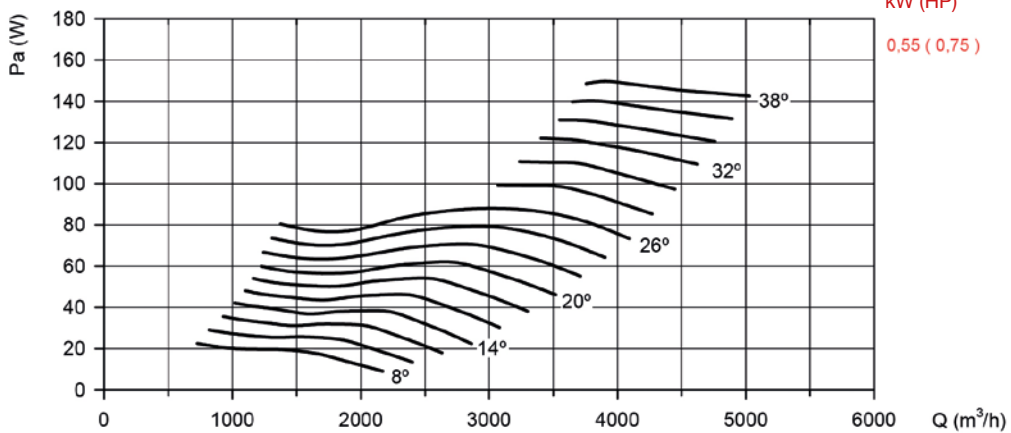

Characteristic curves

Q= Flow rate in m³/h, m³/s and cfm Pe= Static pressure in mm H₂O, Pa and inwg

Impeller diameter in cm: 50

Number of motor poles: 4

Number of blades: 6

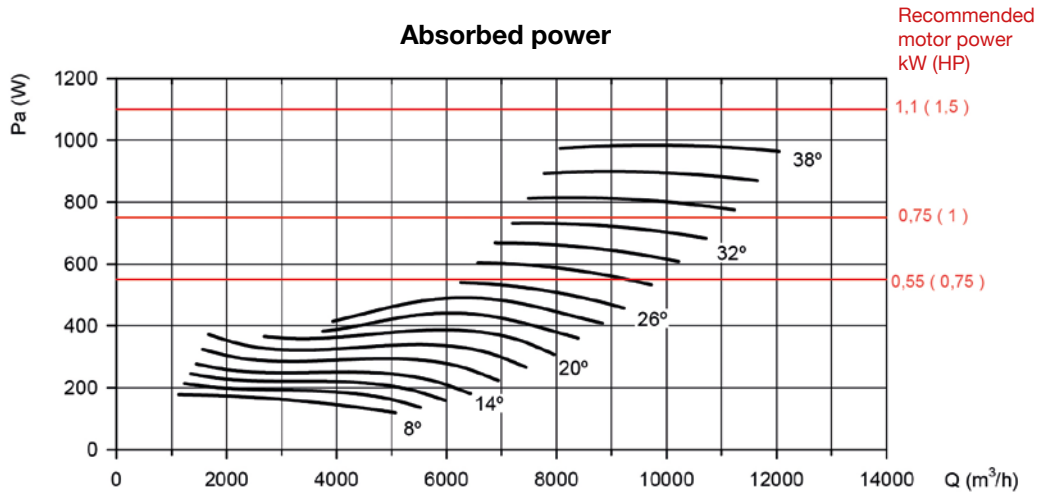
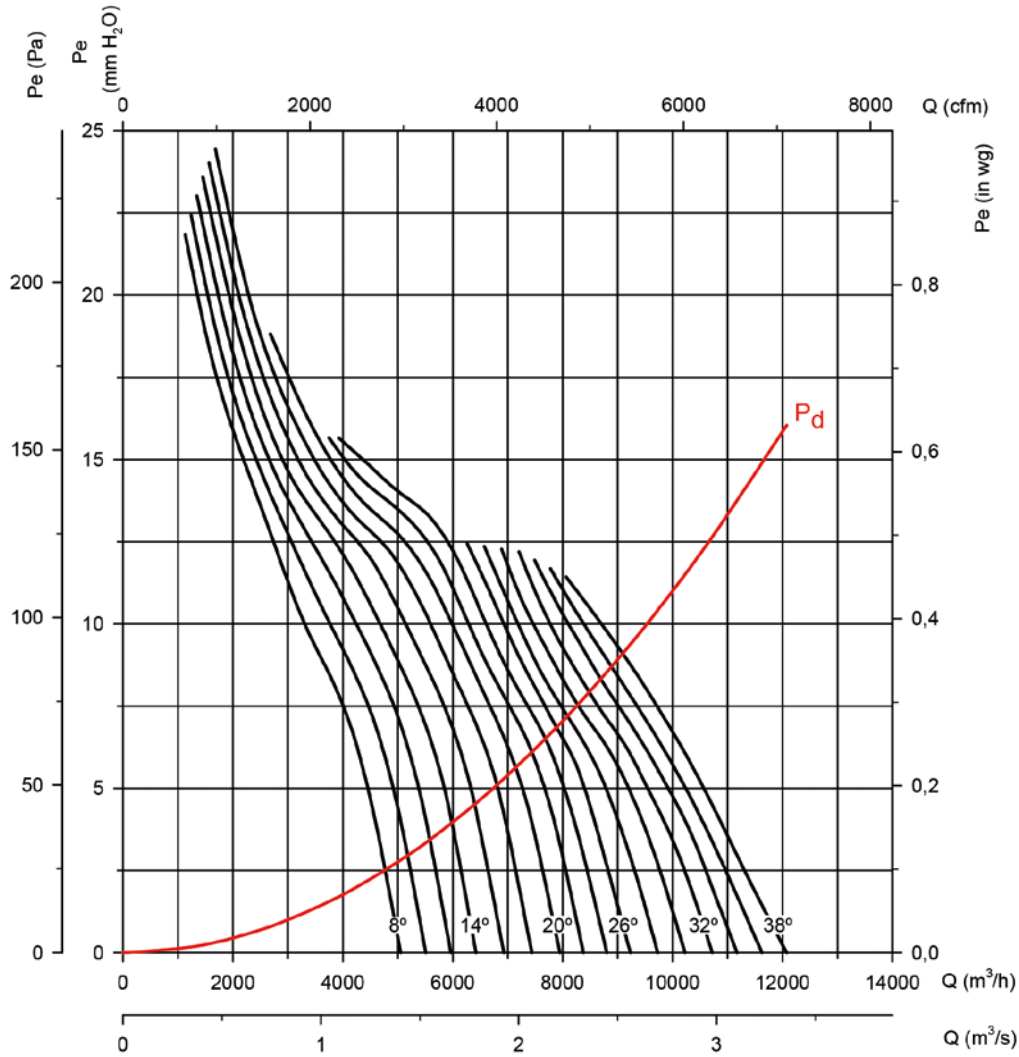

Characteristic curves

Q= Flow rate in m³/h, m³/s and cfm Pe= Static pressure in mm H₂O, Pa and inwg

Impeller diameter in cm: 50

Number of motor poles: 6

Number of blades: 6

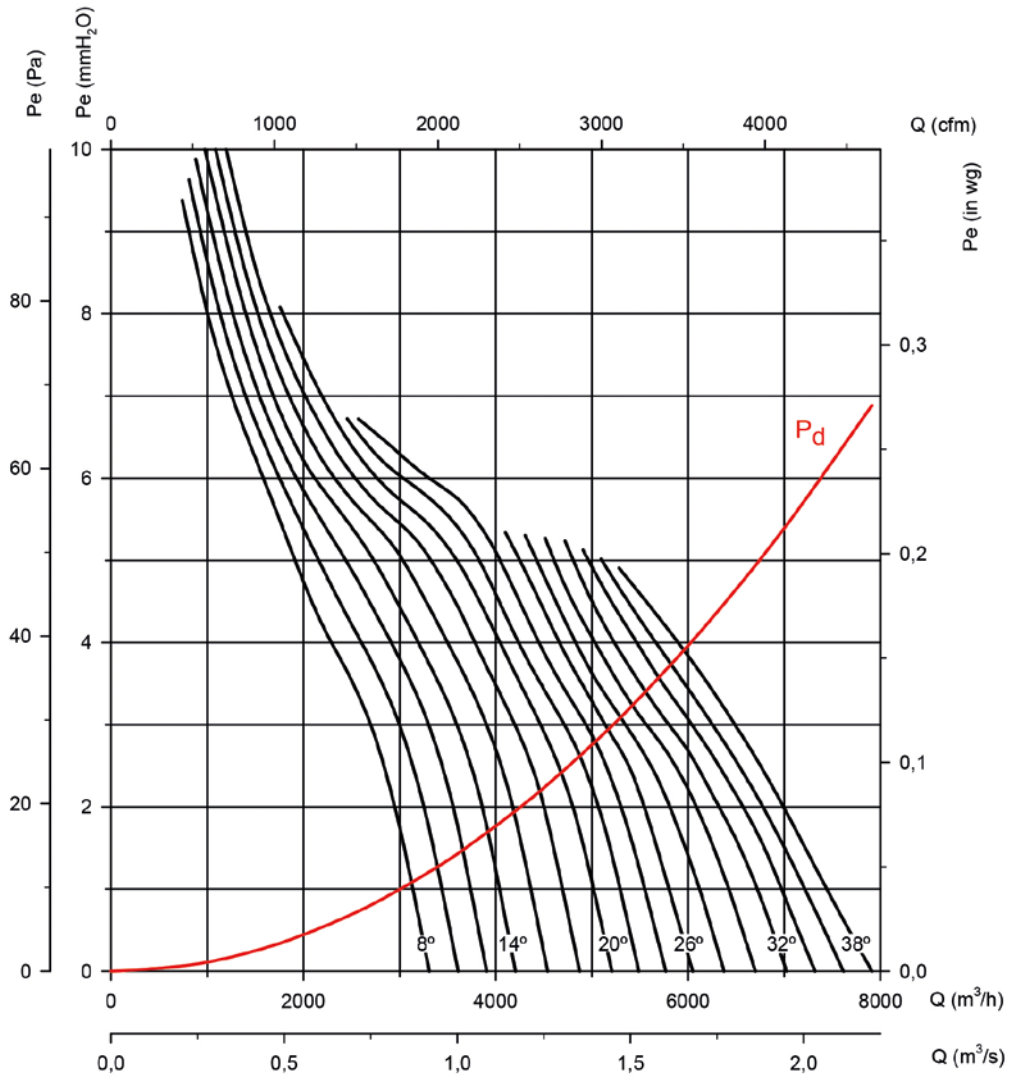

Absorbed power

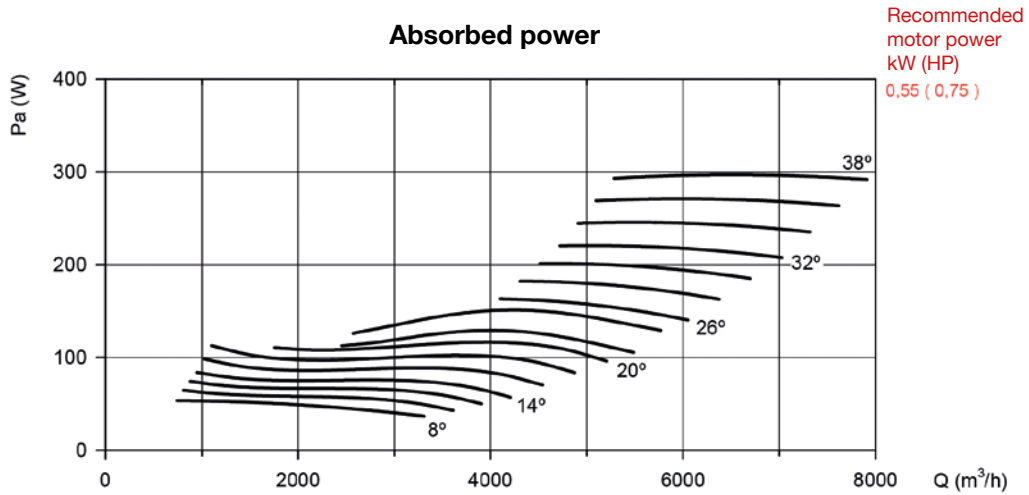

Characteristic curves

Q= Flow rate in m³/h, m³/s and cfm

Pe= Static pressure in mm H₂O, Pa and inwg

Impeller diameter in cm: 56

Number of motor poles: 4

Number of blades: 6

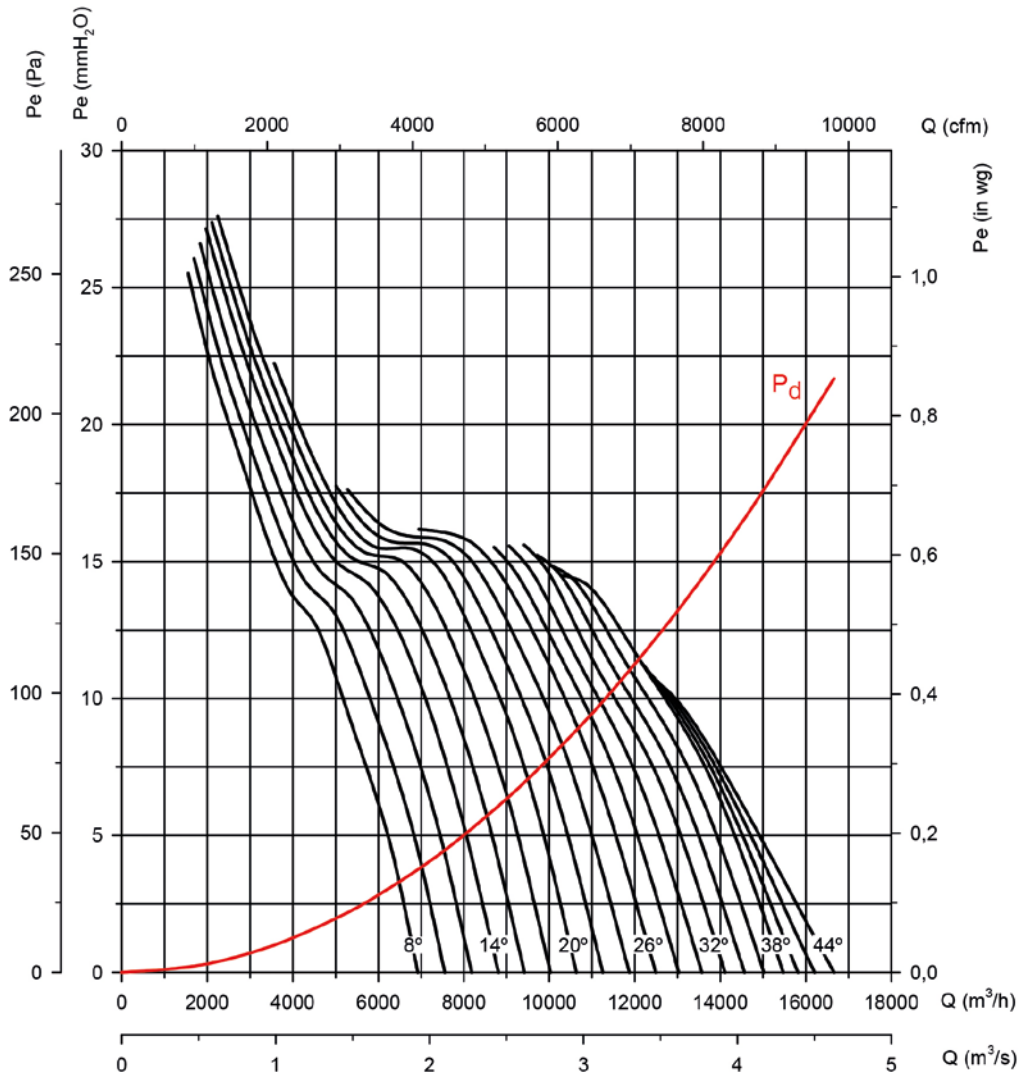

Absorbed power

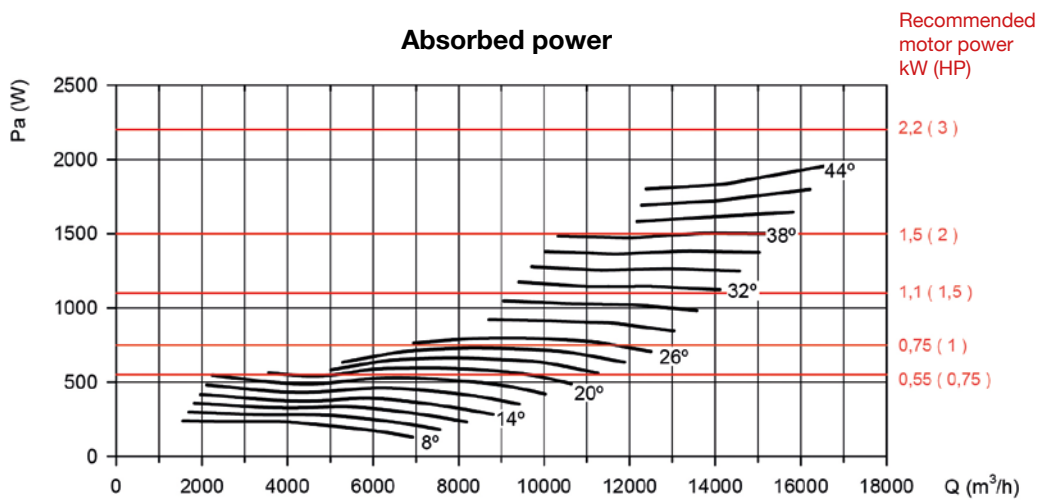

Characteristic curves

Q= Flow rate in m³/h, m³/s and cfm Pe= Static pressure in mm H₂O, Pa and inwg

Impeller diameter in cm: 56

Number of motor poles: 6

Number of blades: 6

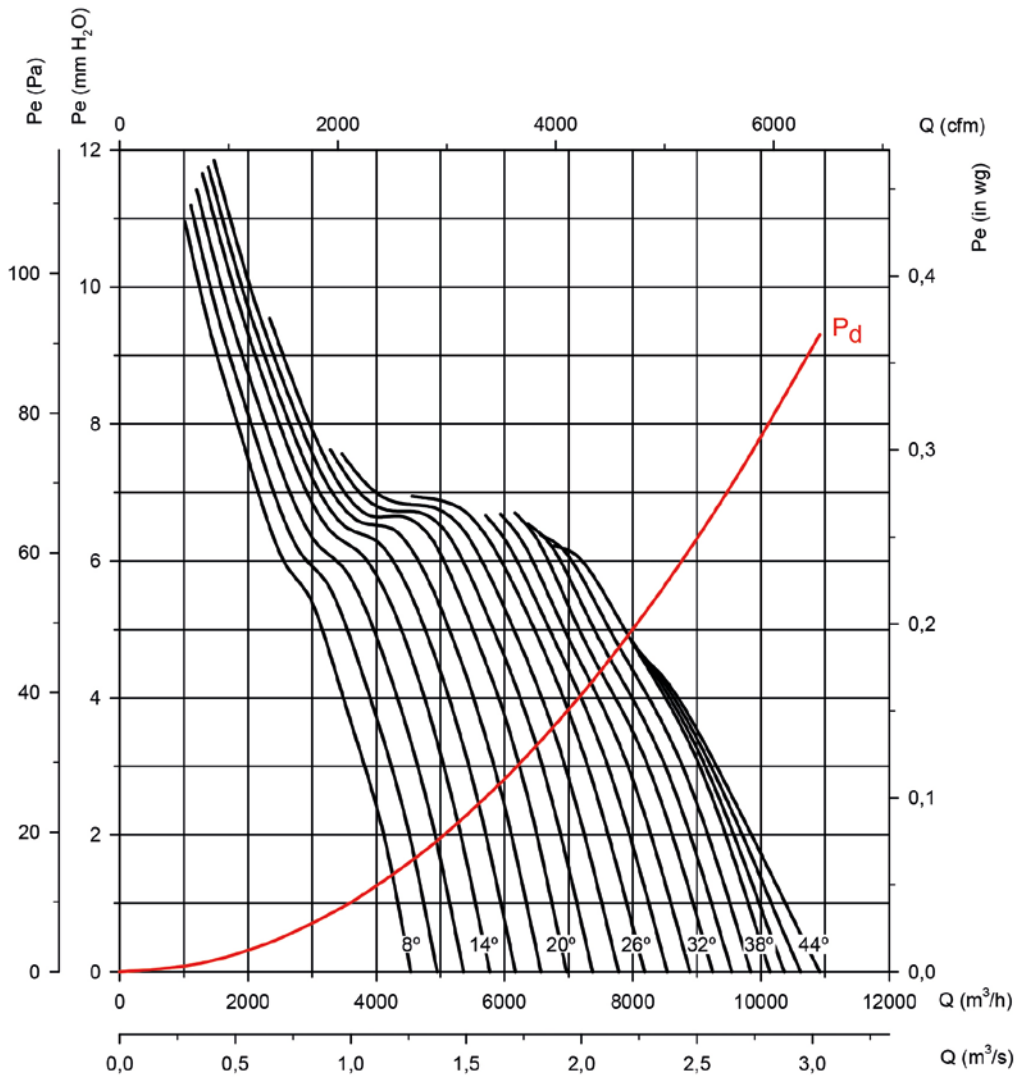

Absorbed power

Recommended motor power kW (HP)

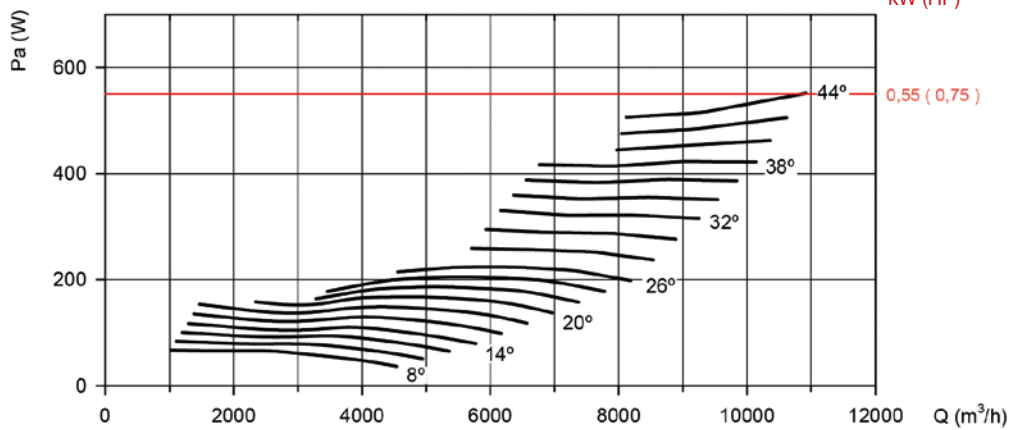

Characteristic curves

Q= Flow rate in m³/h, m³/s and cfm

Pe= Static pressure in mm H₂O, Pa and inwg

Impeller diameter in cm: 63

Number of motor poles: 4

Number of blades: 6

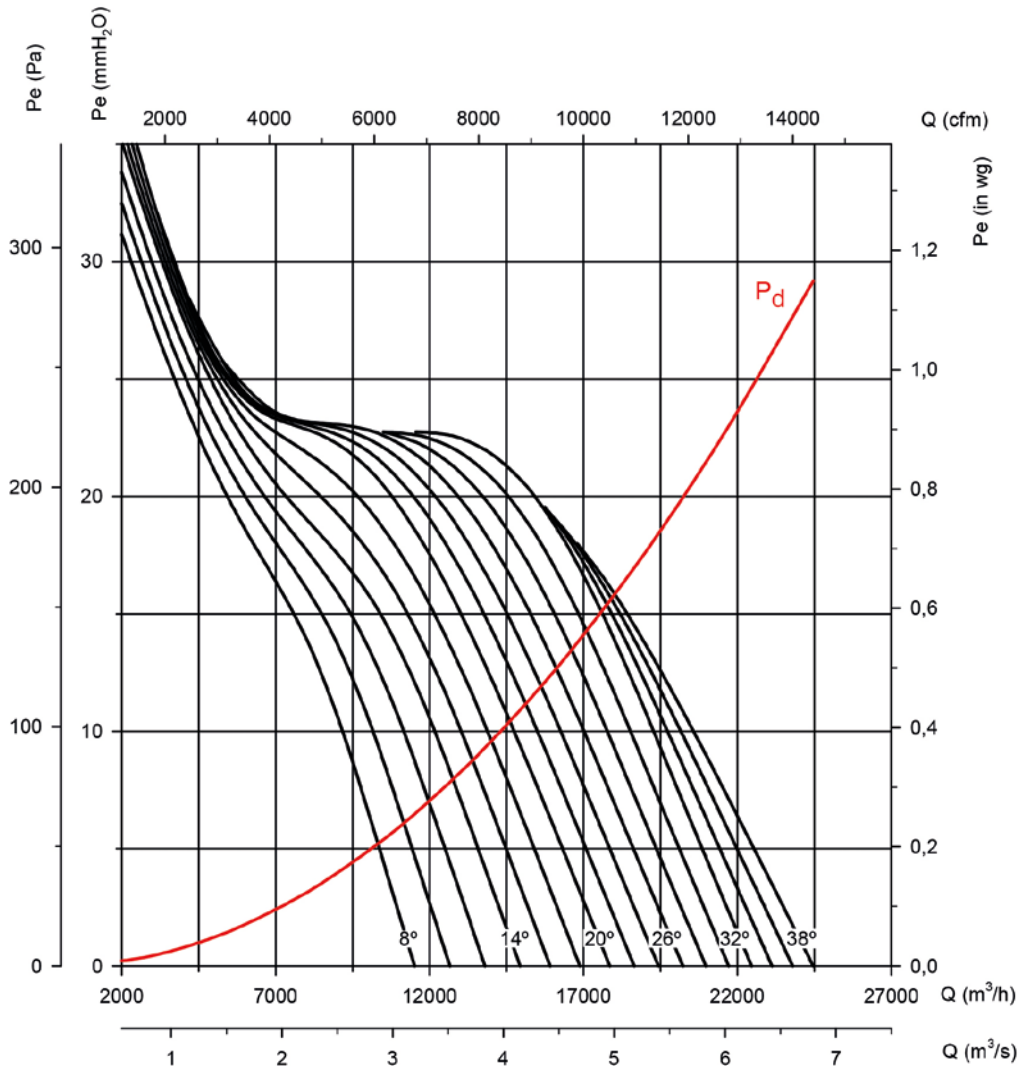

Absorbed power

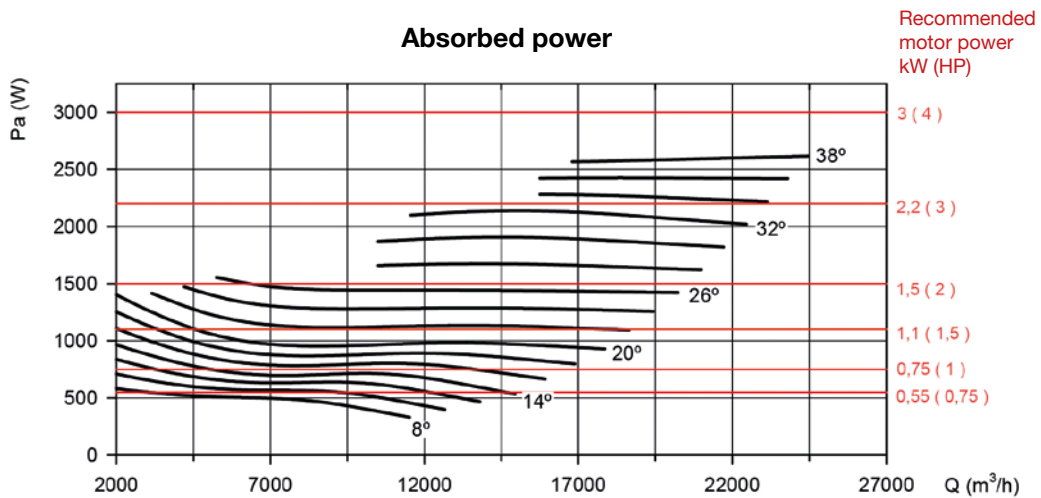

Characteristic curves

Q= Flow rate in m³/h, m³/s and cfm Pe= Static pressure in mm H₂O, Pa and inwg

Impeller diameter in cm: 63

Number of motor poles: 6

Number of blades: 6

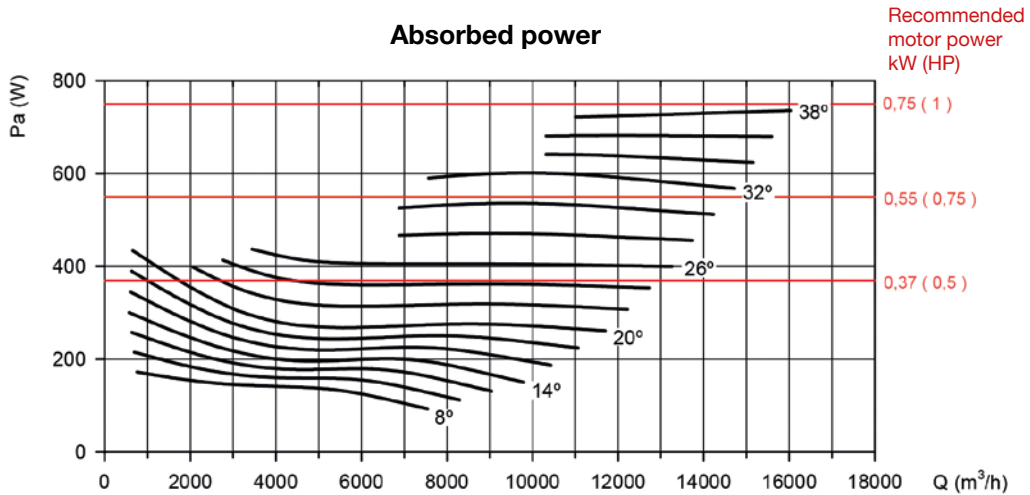
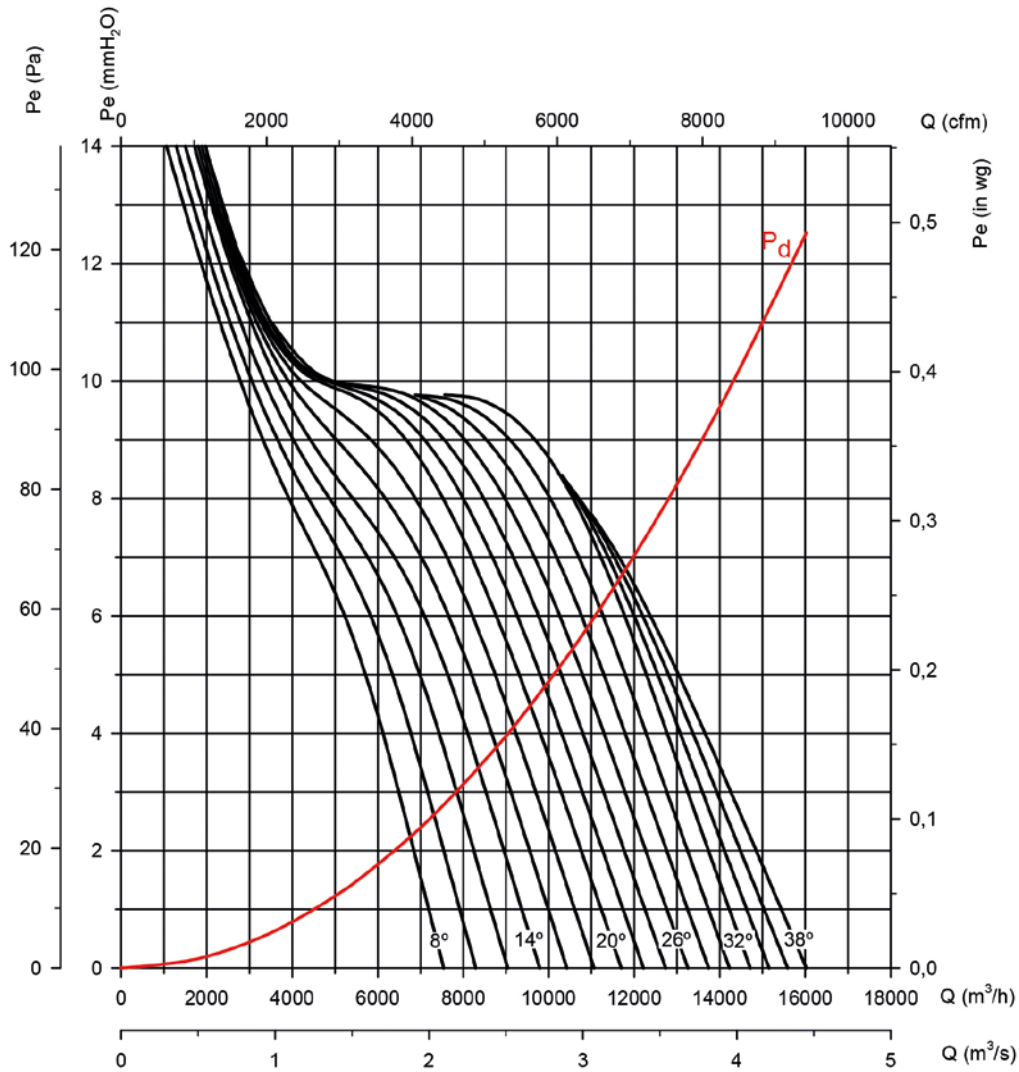

Characteristic curves

Q= Flow rate in m³/h, m³/s and cfm Pe= Static pressure in mm H₂O, Pa and inwg

Impeller diameter in cm: 71

Number of motor poles: 4

Number of blades: 6

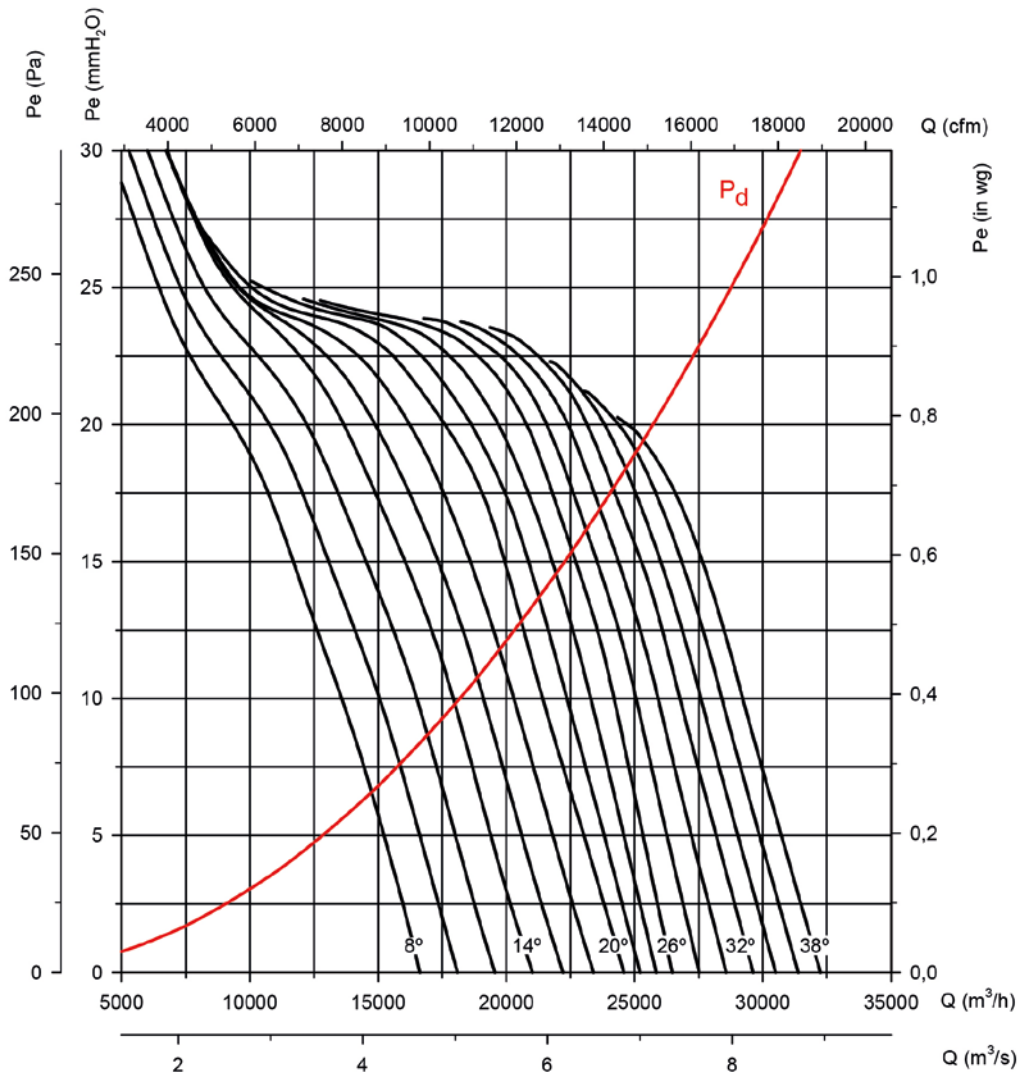

Absorbed power

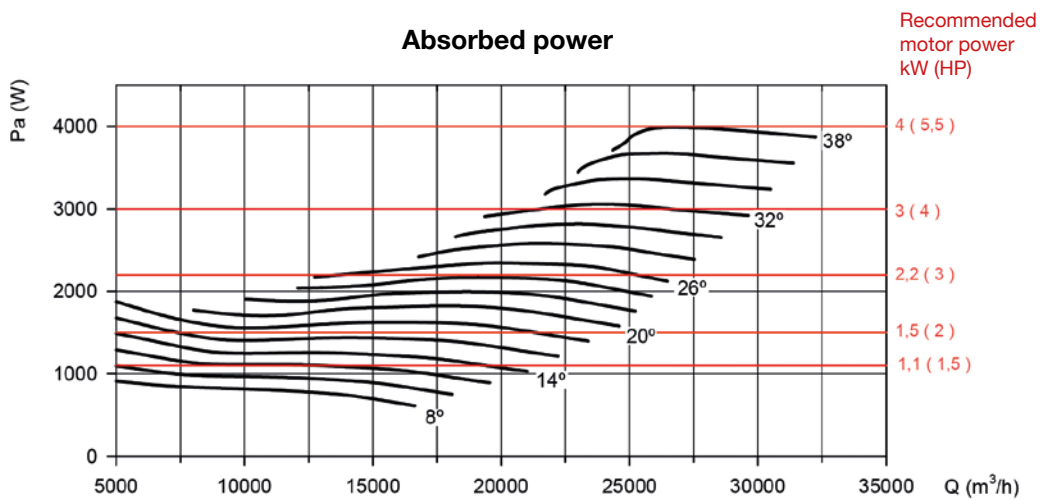

Characteristic curves

Q= Flow rate in m³/h, m³/s and cfm Pe= Static pressure in mm H₂O, Pa and inwg

Impeller diameter in cm: 71

Number of motor poles: 6

Number of blades: 6

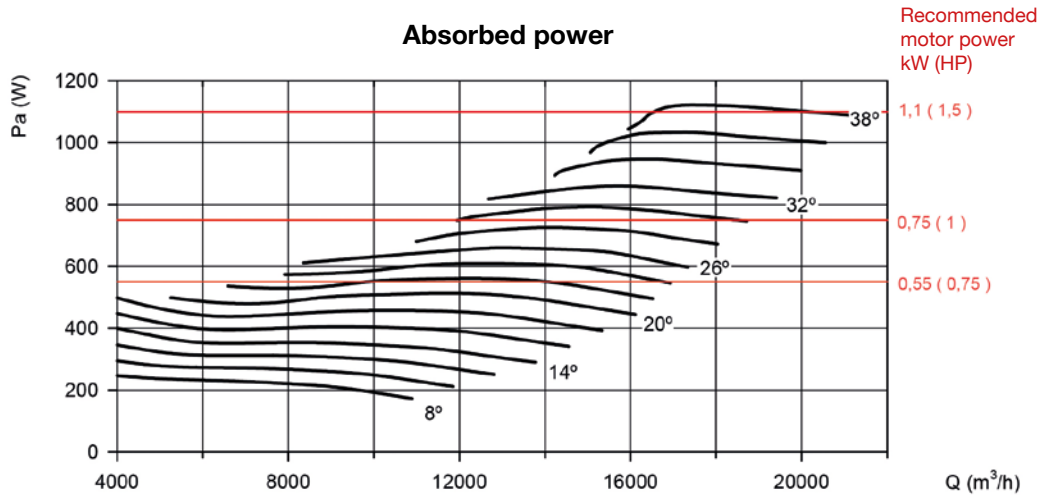
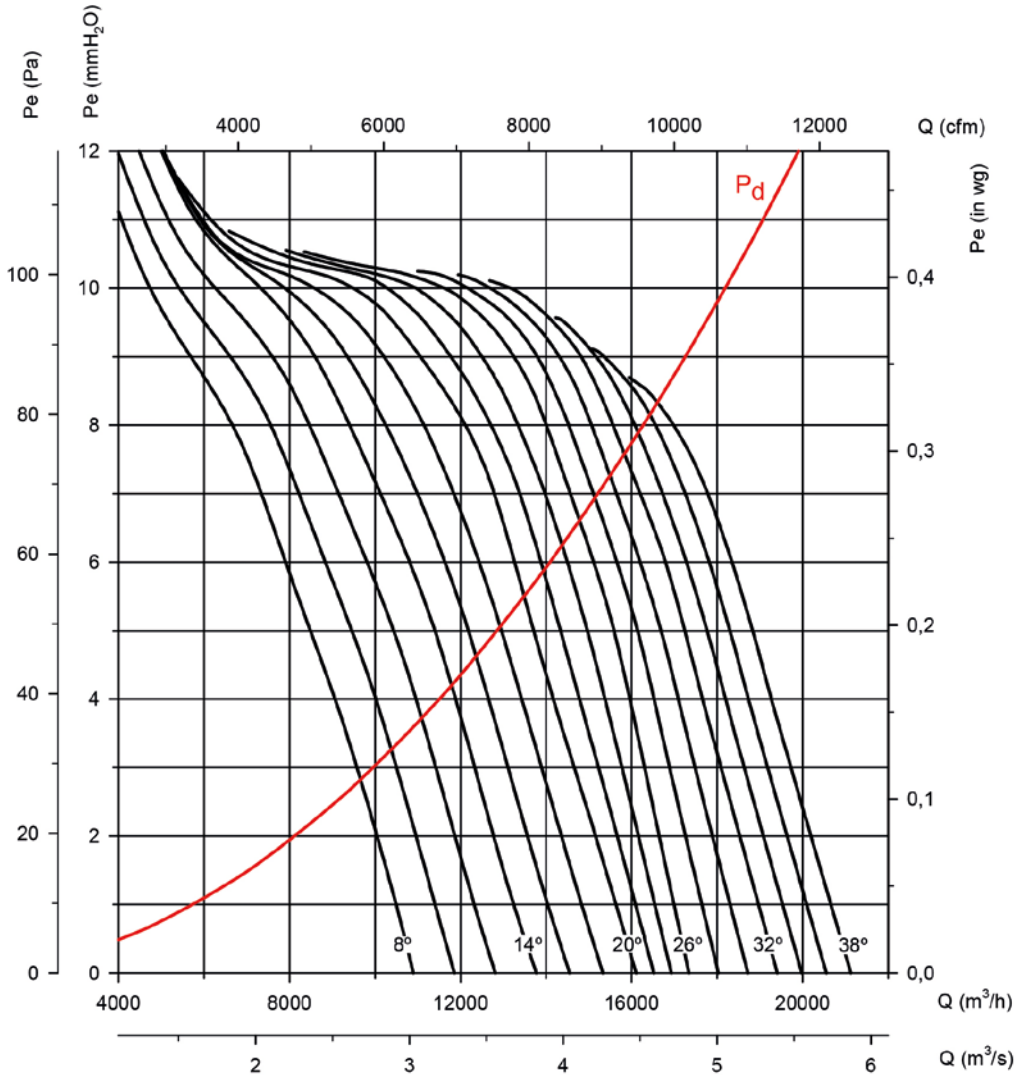

Characteristic curves

Q= Flow rate in m³/h, m³/s and cfm

Pe= Static pressure in mm H₂O, Pa and inwg

Impeller diameter in cm: 80

Number of motor poles: 4

Number of blades: 6

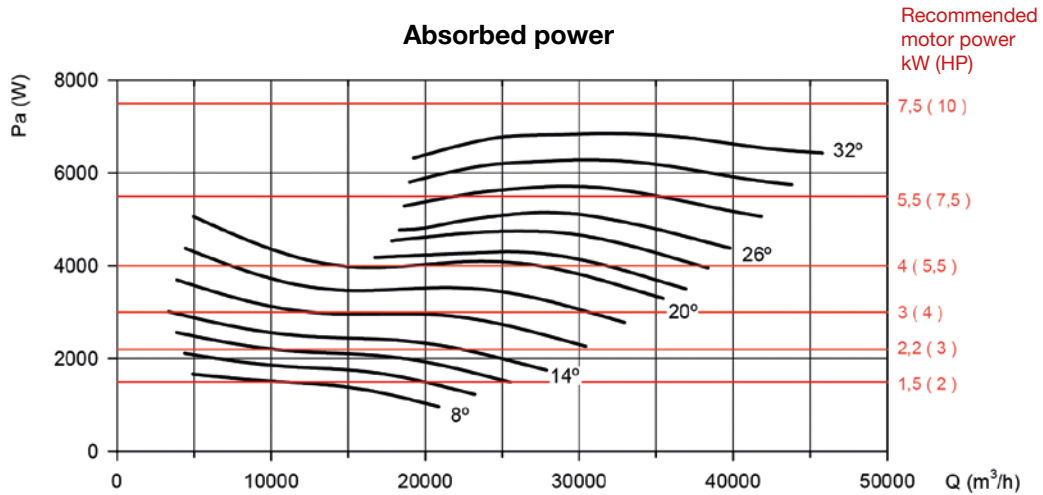
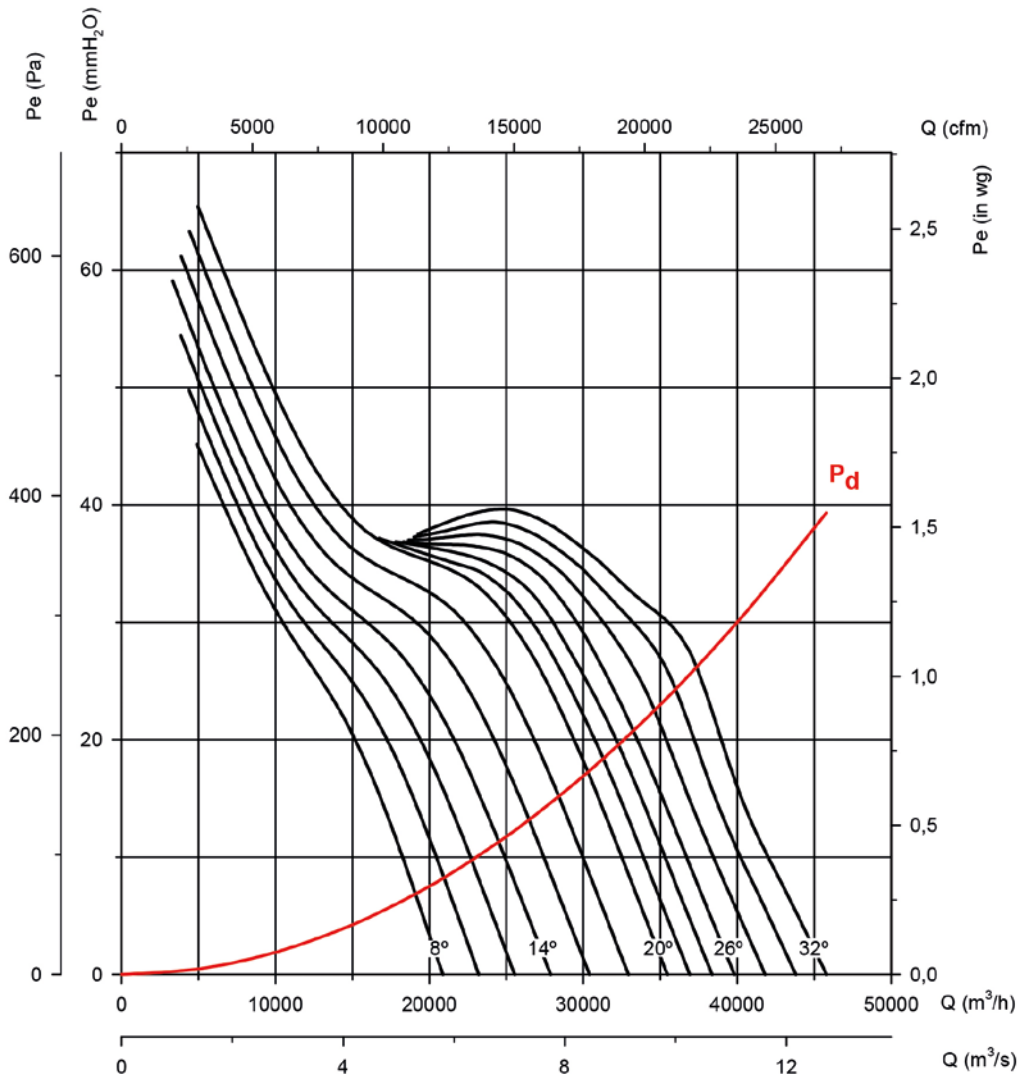

Characteristic curves

Q= Flow rate in m³/h, m³/s and cfm Pe= Static pressure in mm H₂O, Pa and inwg

Impeller diameter in cm: 80

Number of motor poles: 6

Number of blades: 6

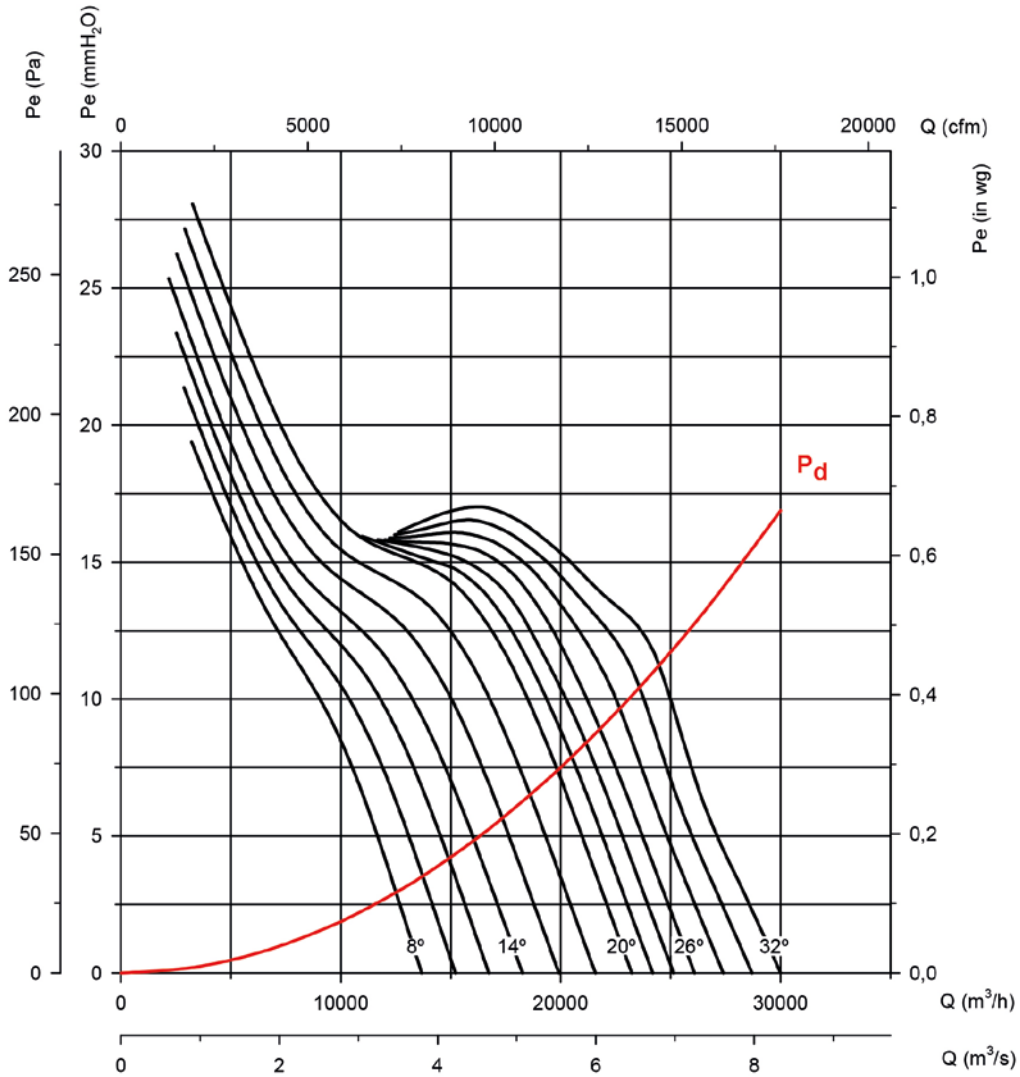

Absorbed power

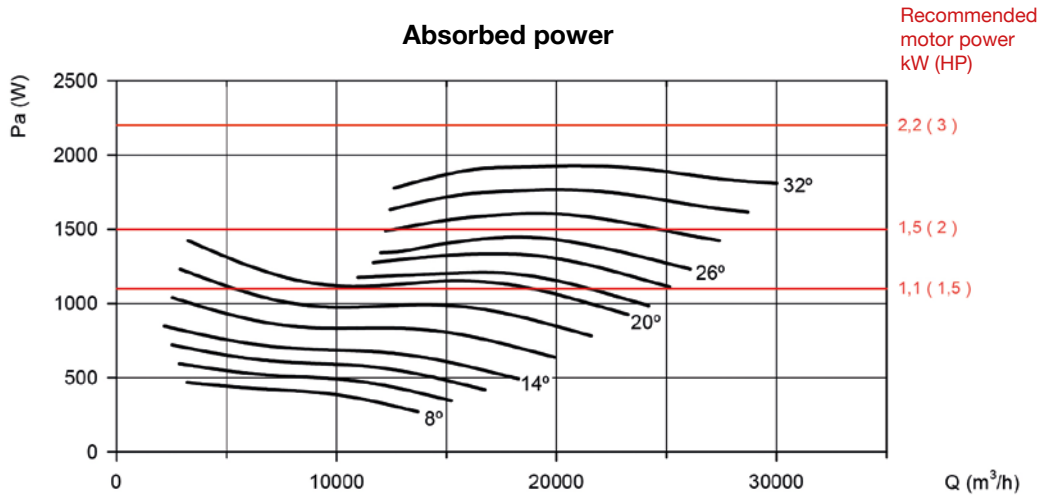

Characteristic curves

Q= Flow rate in m³/h, m³/s and cfm

Pe= Static pressure in mm H₂O, Pa and inwg

Impeller diameter in cm: 80

Number of motor poles: 8

Number of blades: 6

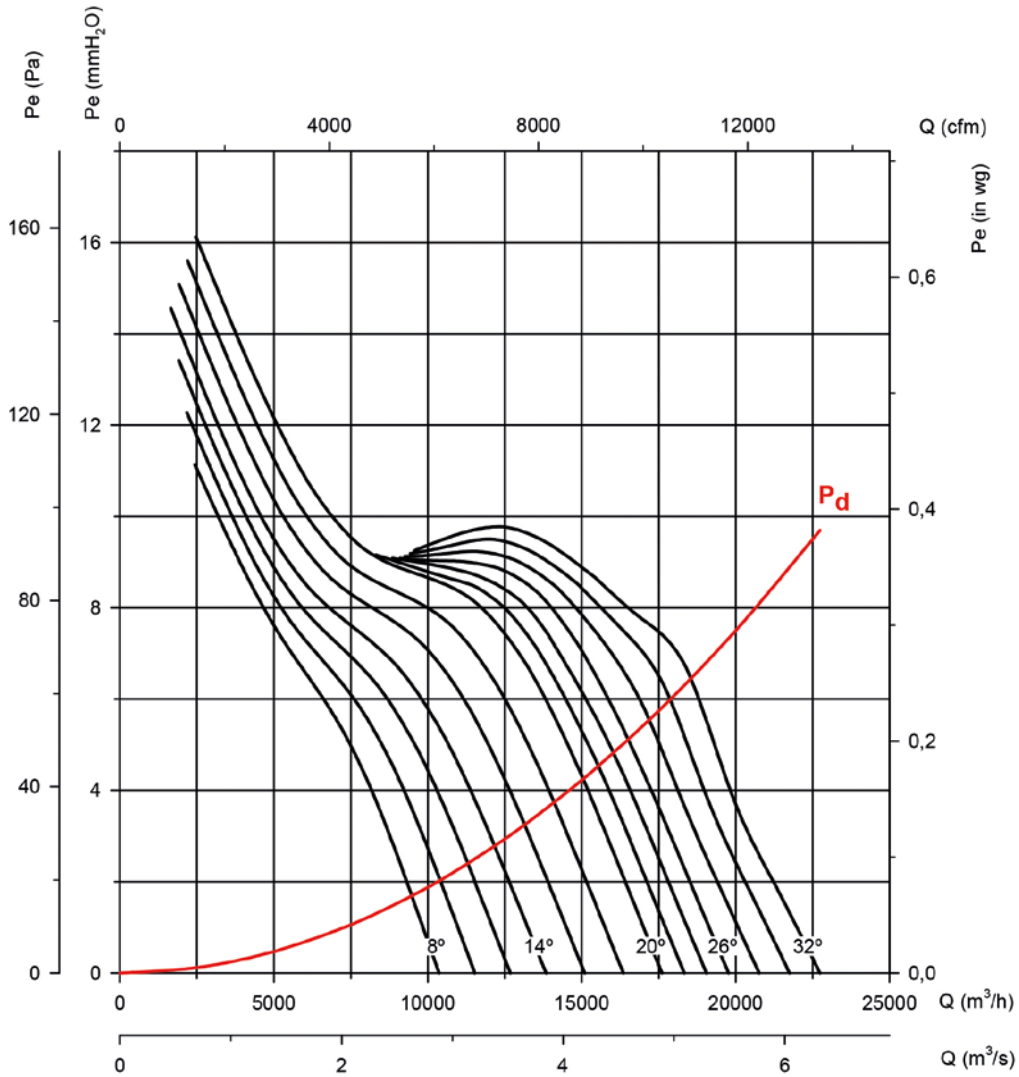

Absorbed power

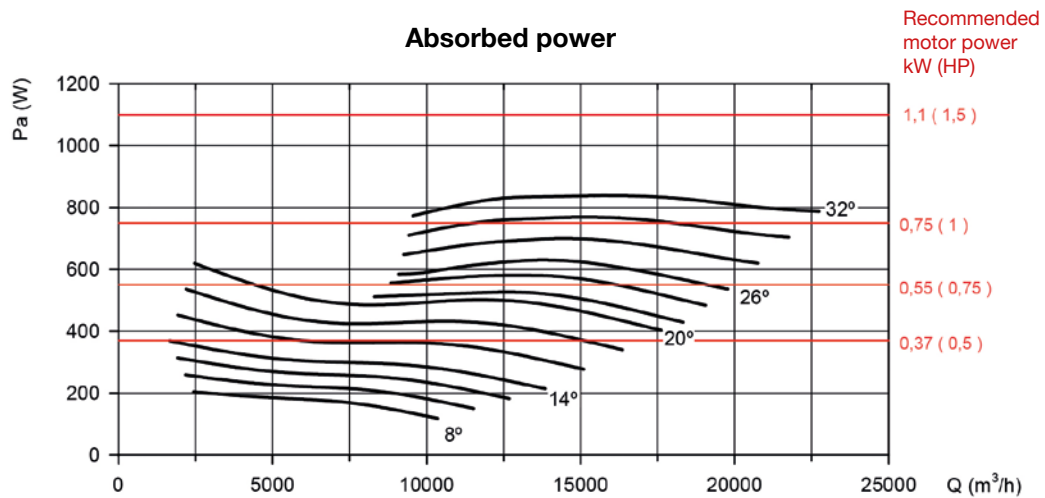

Characteristic curves

Q= Flow rate in m³/h, m³/s and cfm Pe= Static pressure in mm H₂O, Pa and inwg

Impeller diameter in cm: 90

Number of motor poles: 4

Number of blades: 6

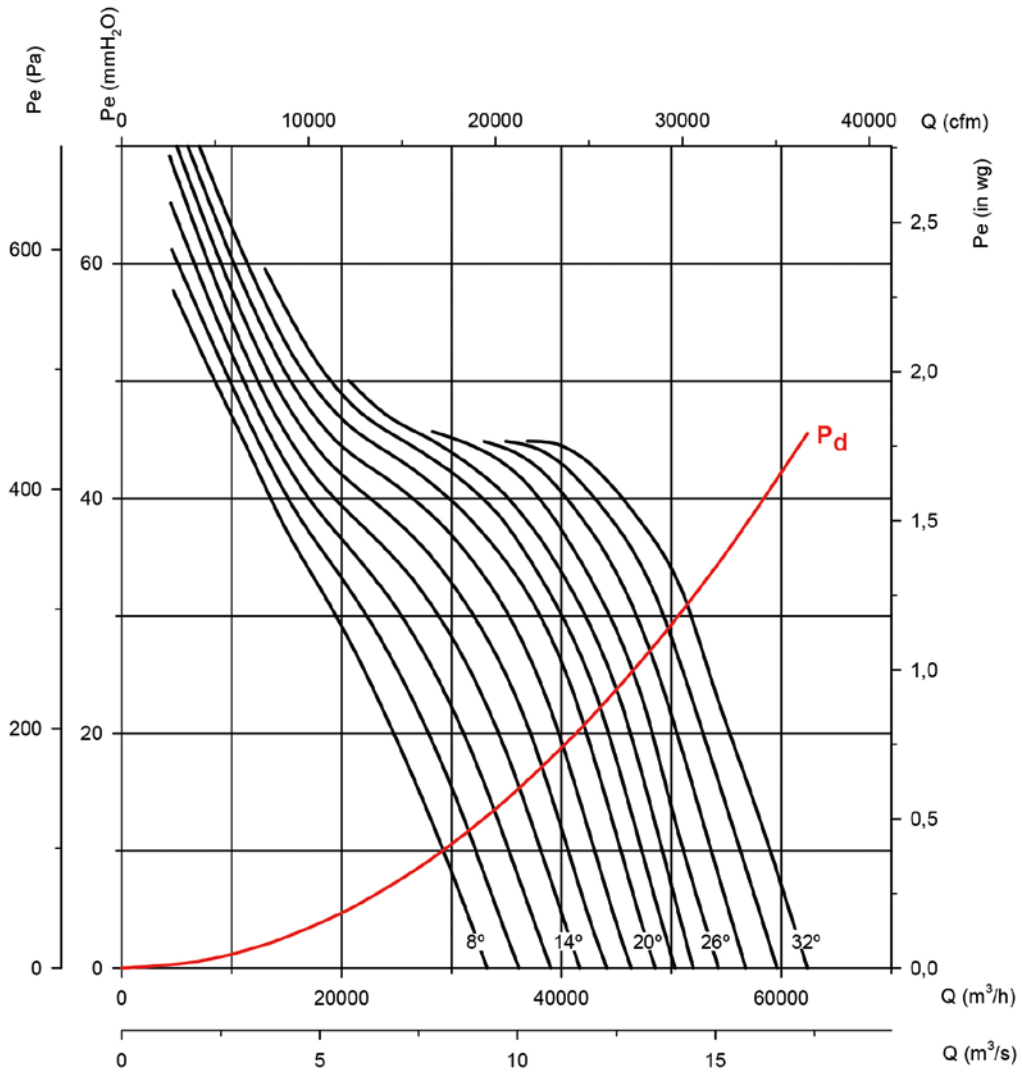

Absorbed power

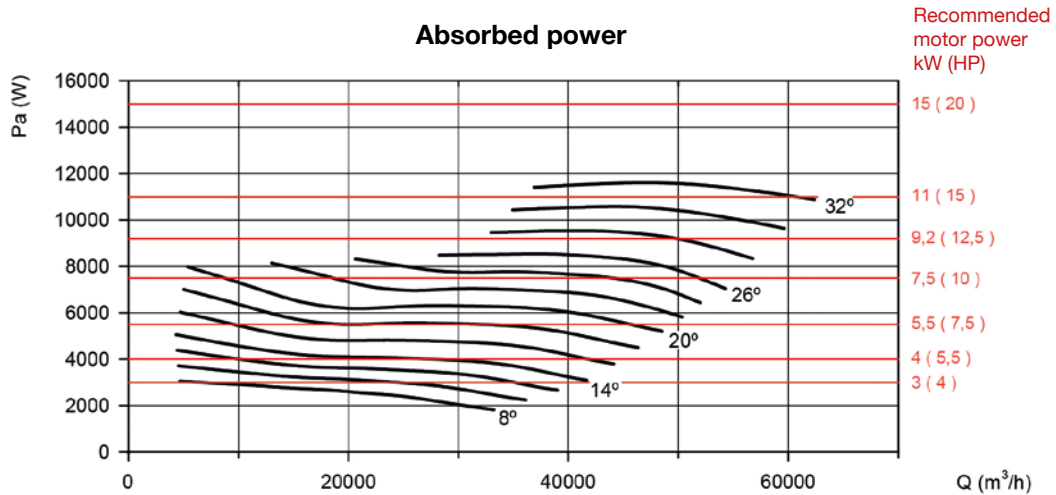

Characteristic curves

Q= Flow rate in m³/h, m³/s and cfm

Pe= Static pressure in mm H₂O, Pa and inwg

Impeller diameter in cm: 90

Number of motor poles: 6

Number of blades: 6

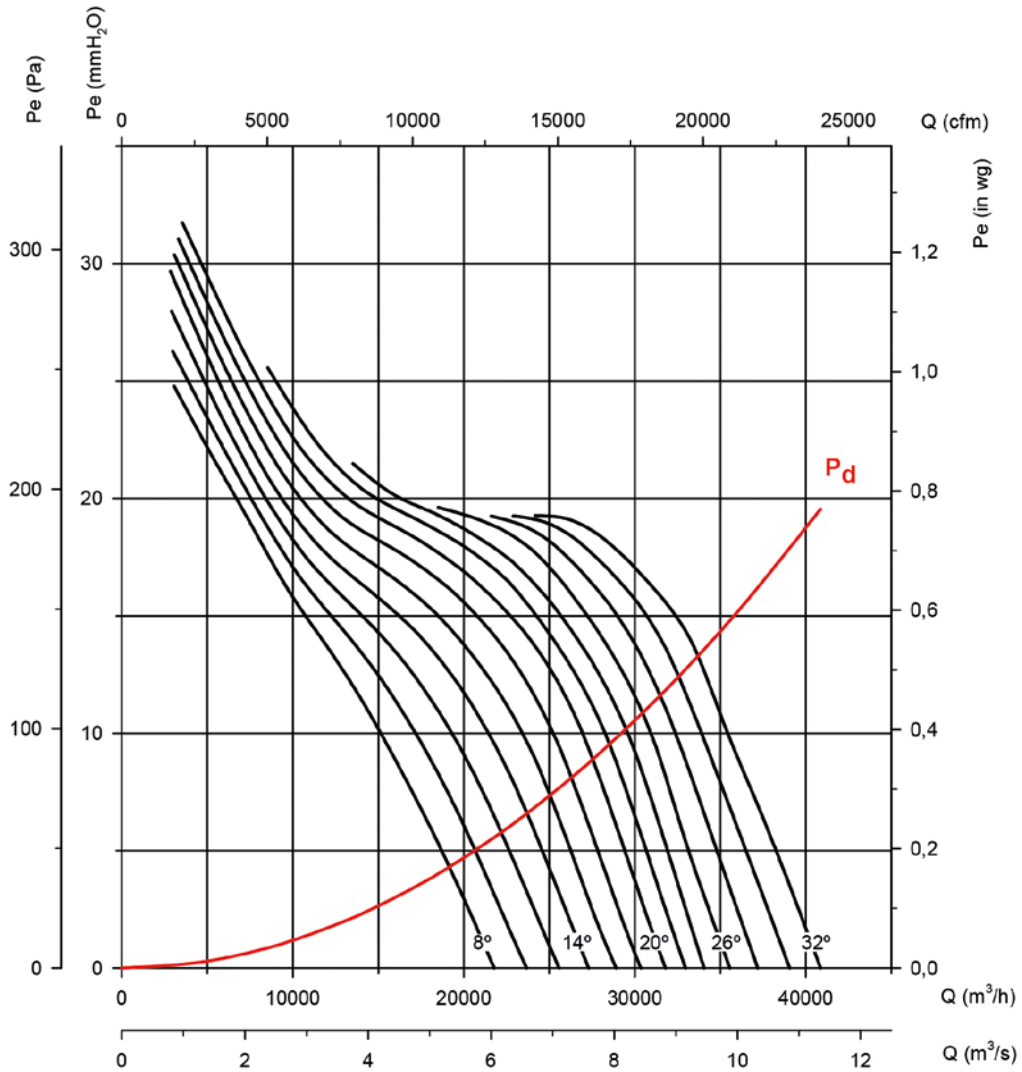

Absorbed power

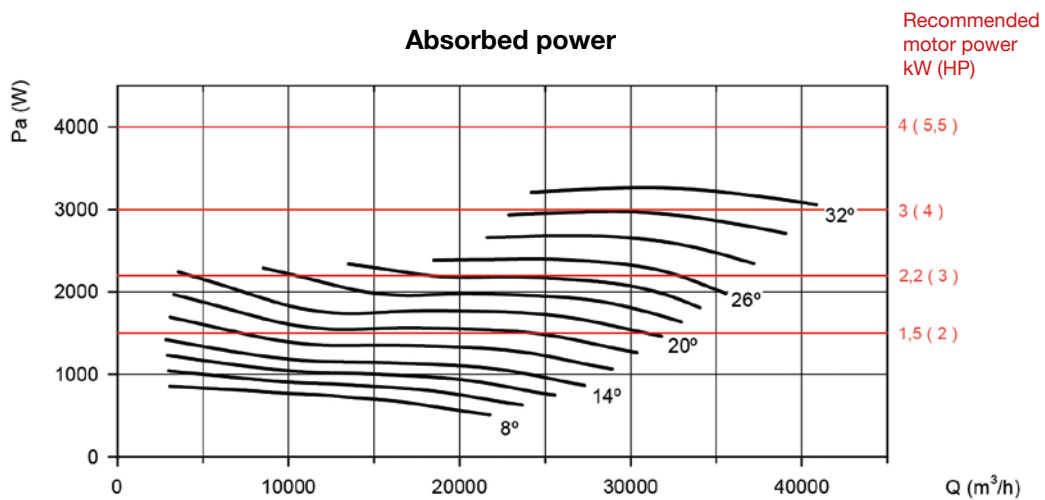

Characteristic curves

Q= Flow rate in m³/h, m³/s and cfm Pe= Static pressure in mm H₂O, Pa and inwg

Impeller diameter in cm: 90

Number of motor poles: 8

Number of blades: 6

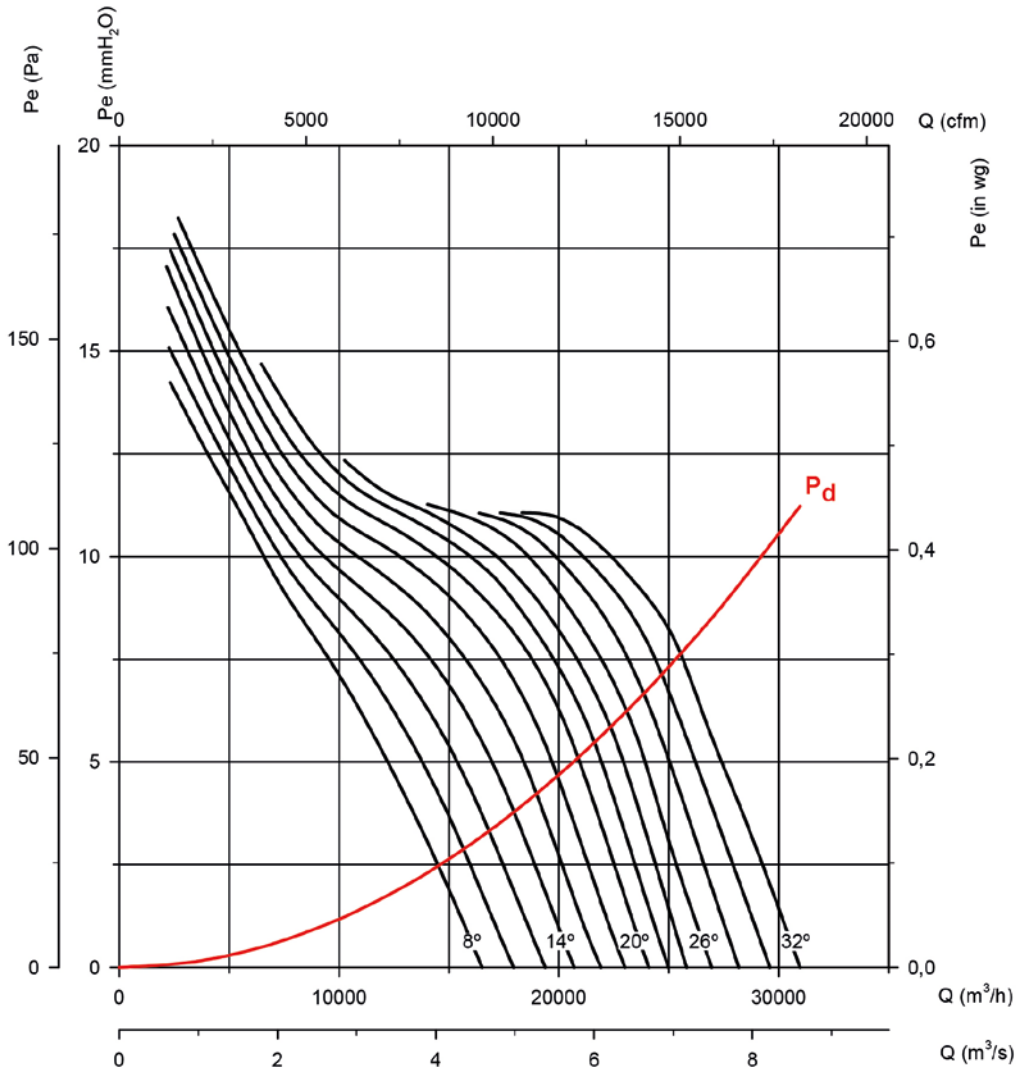

Absorbed power

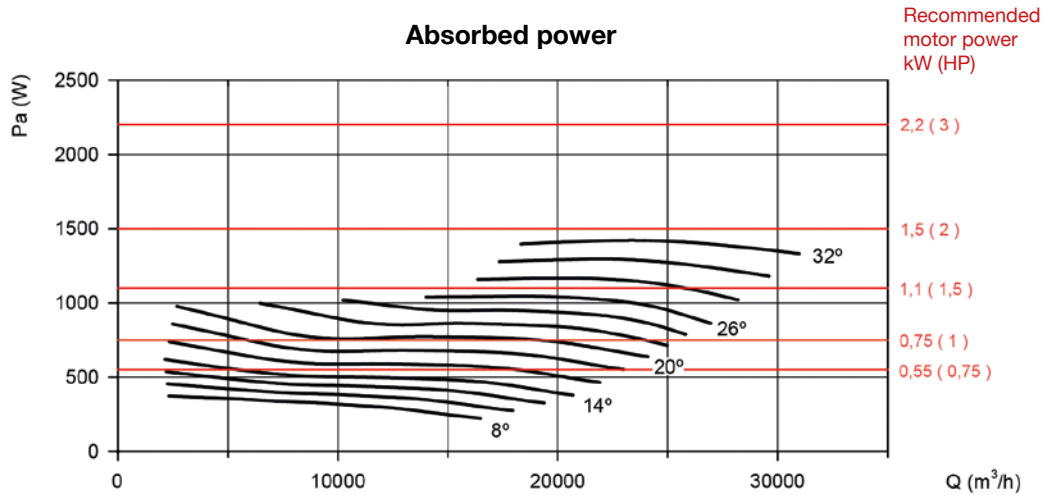

Characteristic curves

Q= Flow rate in m³/h, m³/s and cfm

Pe= Static pressure in mm H₂O, Pa and inwg

Impeller diameter in cm: 100

Number of motor poles: 4

Number of blades: 6

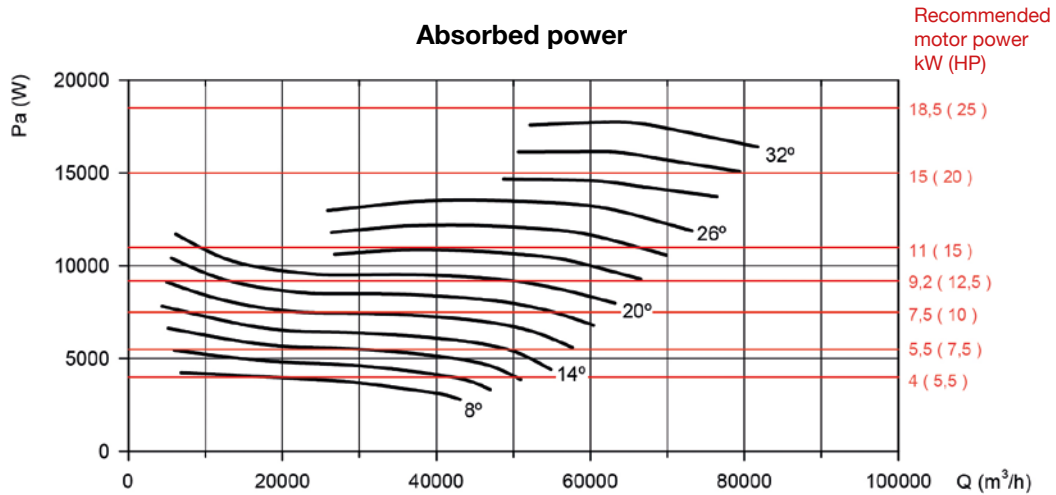
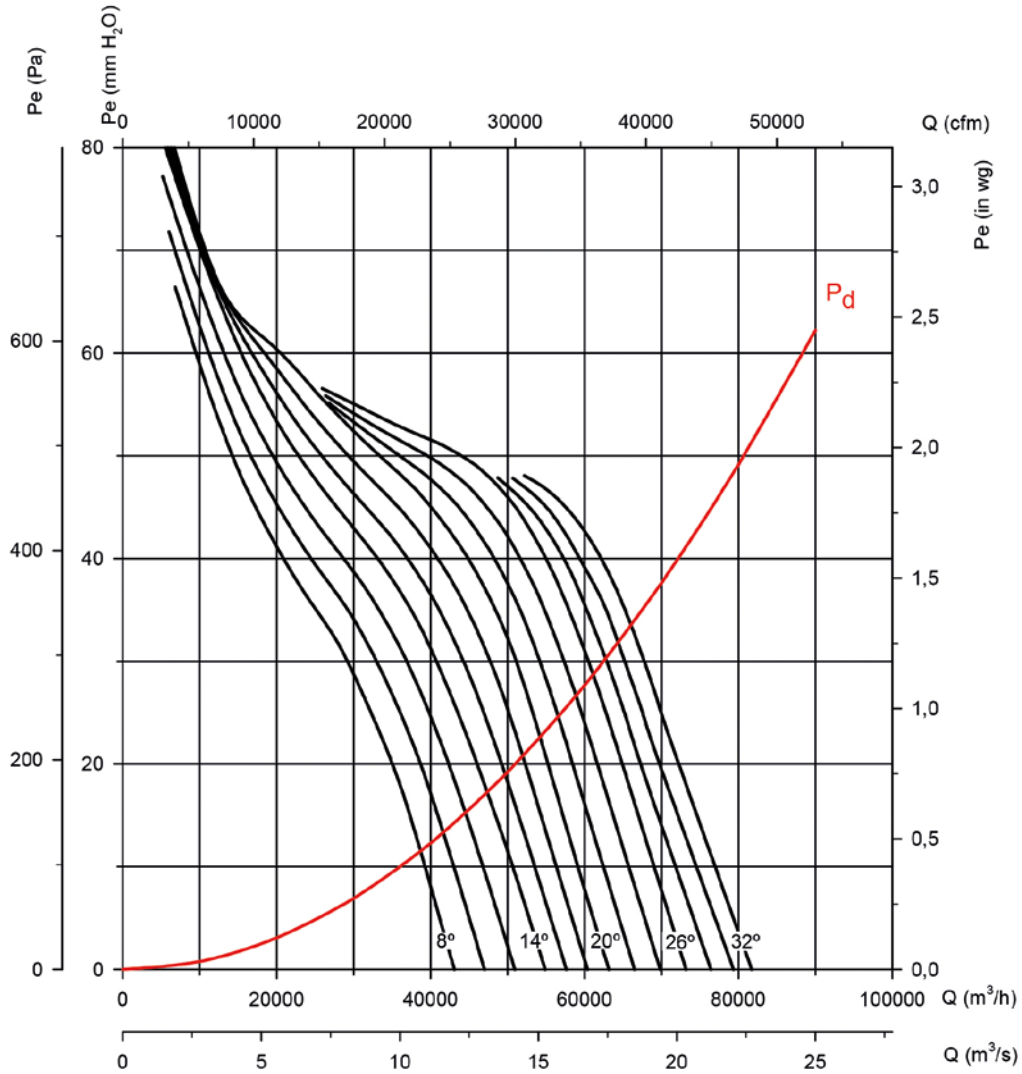

Characteristic curves

Q= Flow rate in m³/h, m³/s and cfm Pe= Static pressure in mm H₂O, Pa and inwg

Impeller diameter in cm: 100

Number of motor poles: 4

Number of blades: 9

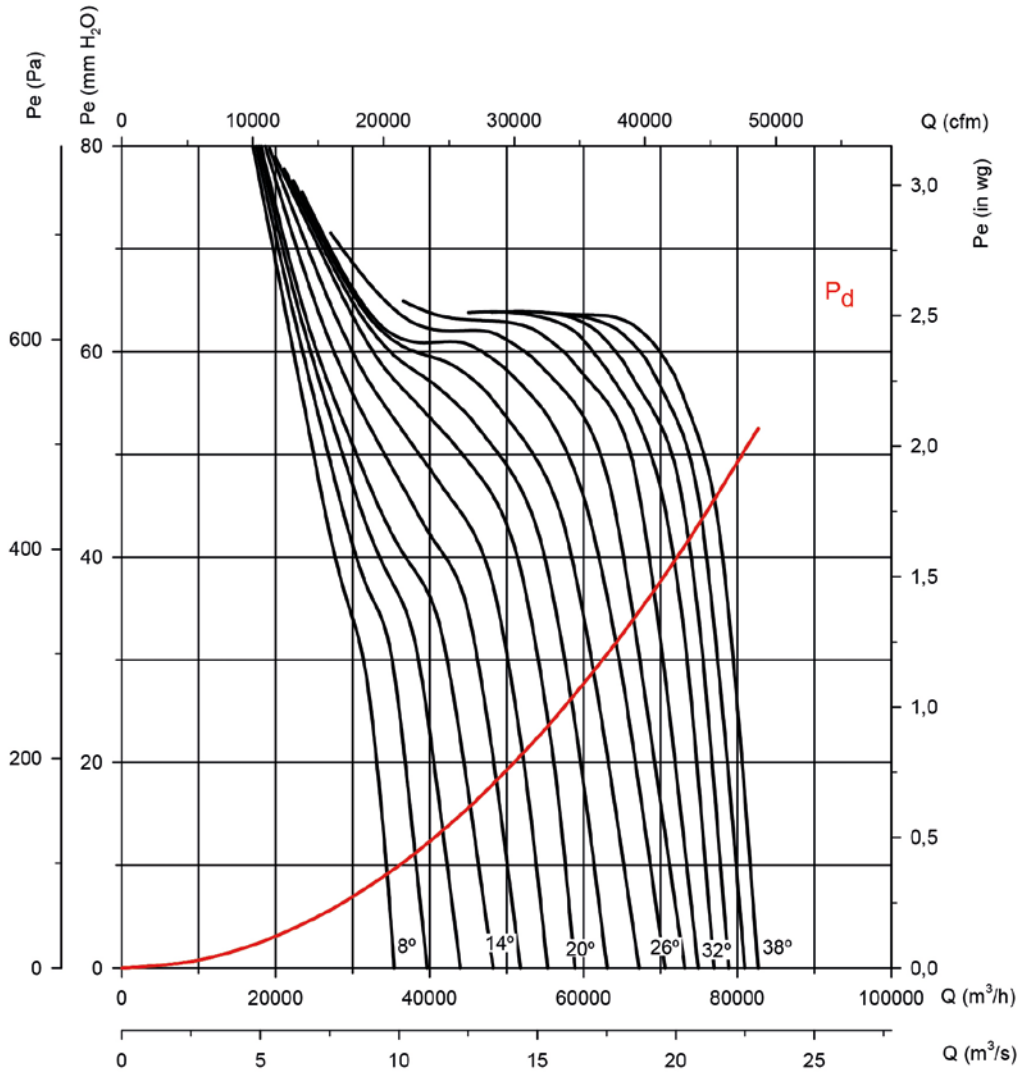

Absorbed power

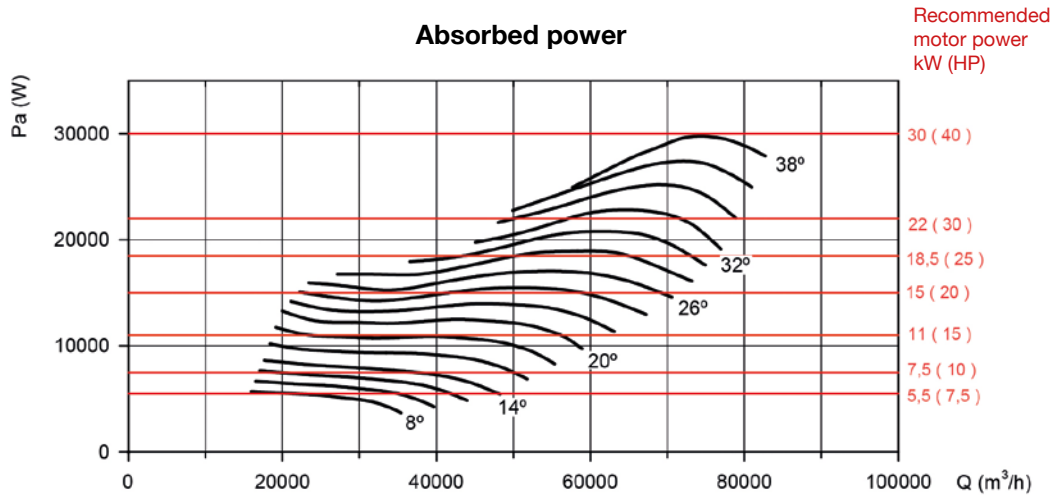

Characteristic curves

Q= Flow rate in m³/h, m³/s and cfm

Pe= Static pressure in mm H₂O, Pa and inwg

Impeller diameter in cm: 100

Number of motor poles: 6

Number of blades: 6

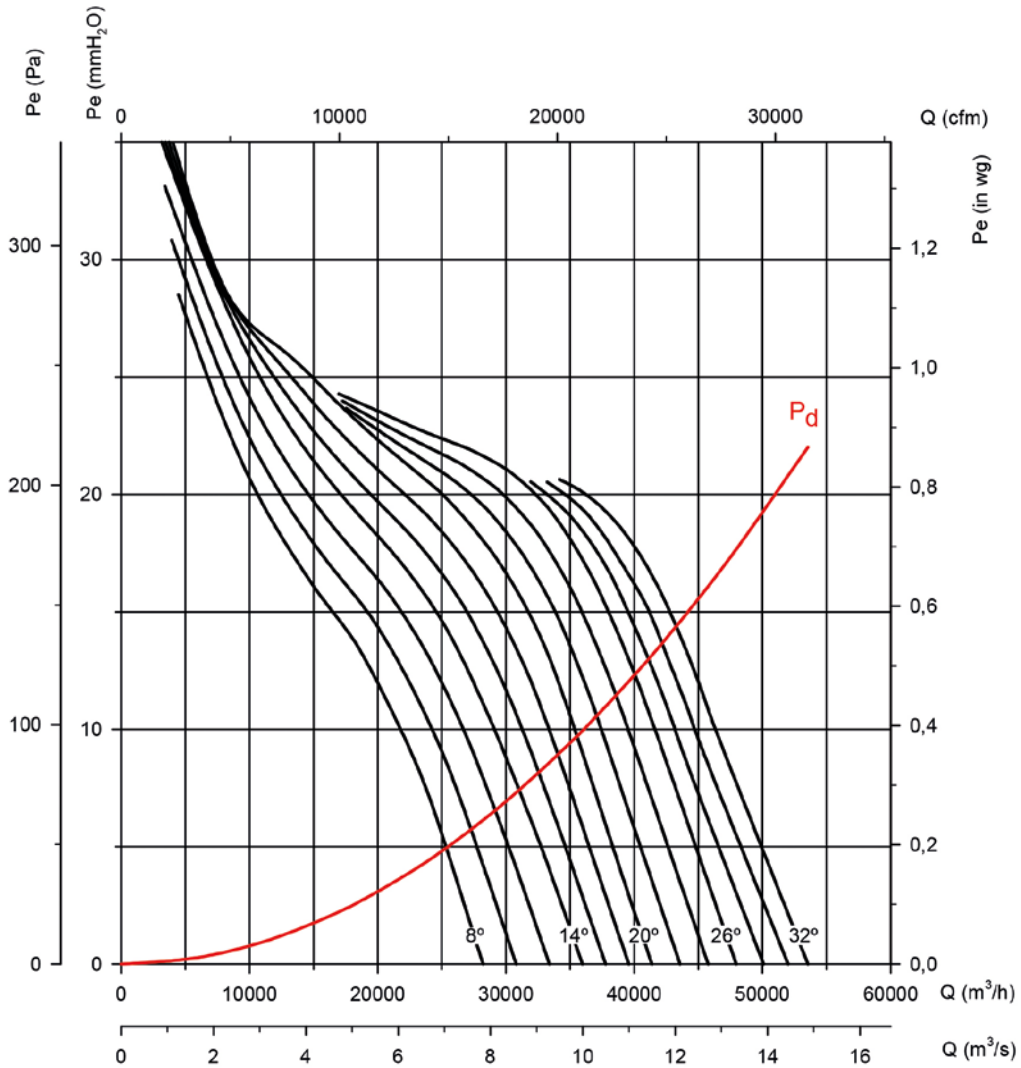

Absorbed power

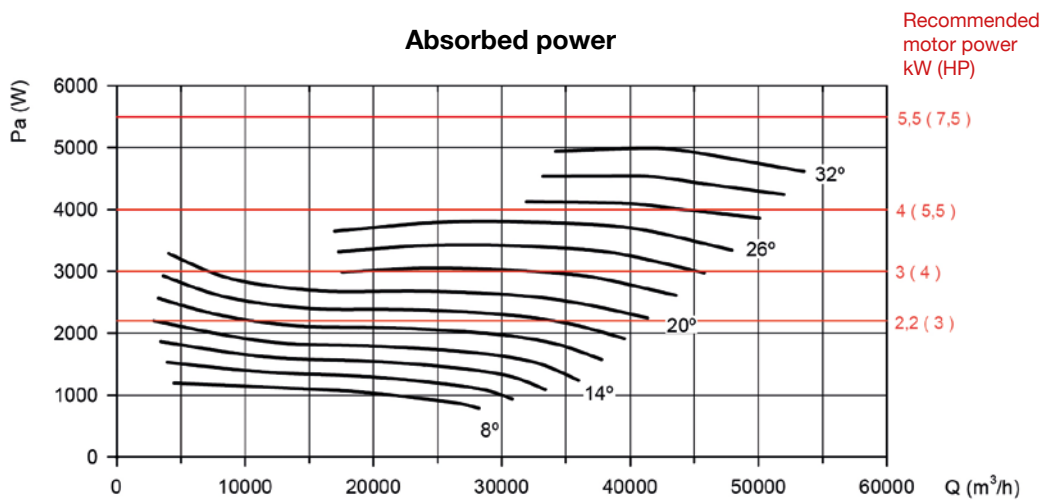

Characteristic curves

Q= Flow rate in m³/h, m³/s and cfm Pe= Static pressure in mm H₂O, Pa and inwg

Impeller diameter in cm: 100

Number of motor poles: 6

Number of blades: 9

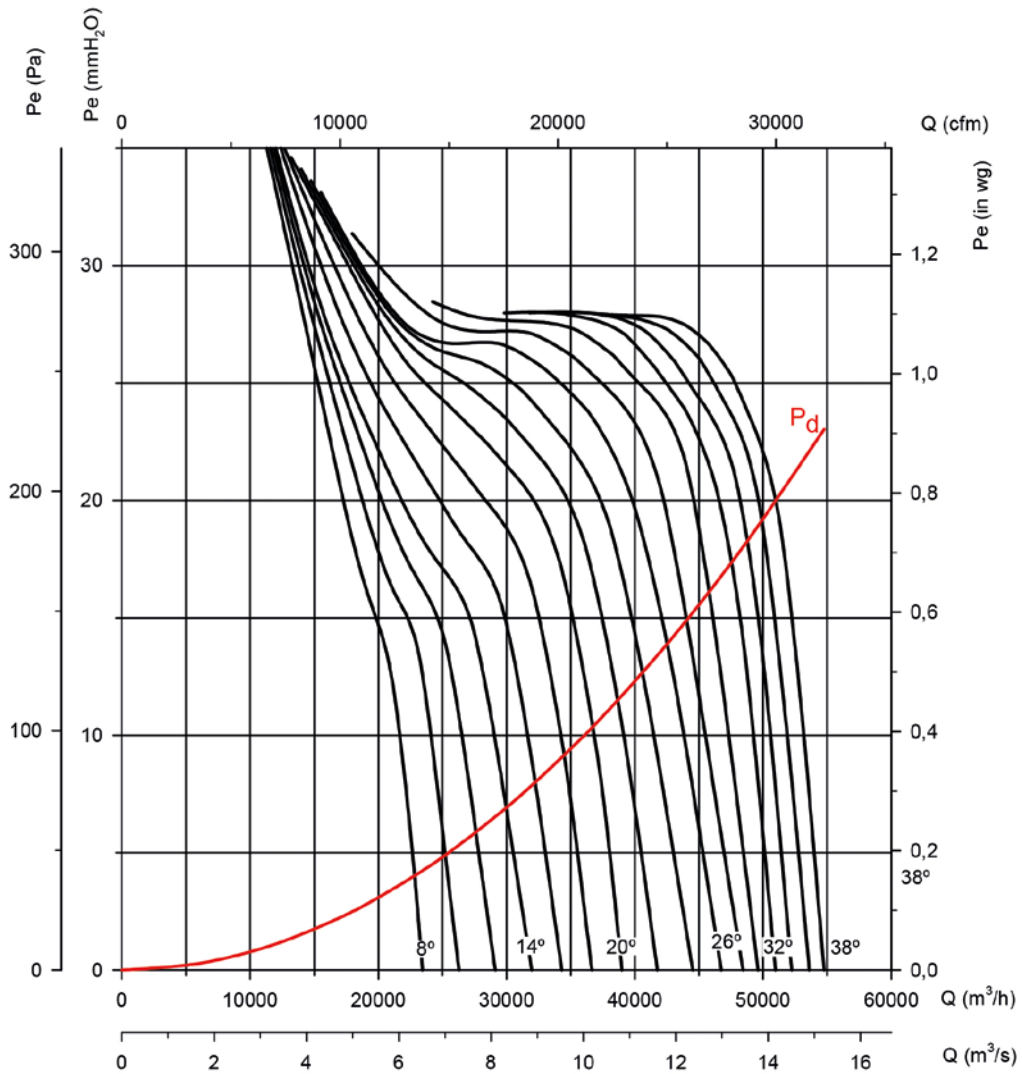

Absorbed power

