



# EC TECHNOLOGY SOLUTIONS



Draft

NEW GENERATION EC FANS



## VENTILATION SOLUTIONS

Since the company was incorporated in 1983, SODECA has focused its business activity on designing and manufacturing industrial fans, ventilation systems and smoke exhaust fans.

SODECA fans and extractor systems undergo the most stringent quality procedures certified by BUREAU VERITAS, in accordance with 9001:2015. The quality of the product as well as the research and development methods used have made it possible for SODECA to become one of the most renowned fan manufacturers in the world.

Among other aspects, one of our most important values is being customer service oriented, which is why we have outstanding professionals assigned to assist you in offering the best fan solution adapted to the requirements of each project.

SODECA's main installations have a surface area of more than 15,000 m<sup>2</sup> and are located in Ripoll, a town near Barcelona. The building was built in 2018 and has been recognised for its energy management system. Among other aspects, the installations are equipped with a hermetically designed automated shutter system to improve energy efficiency.

We offer you the possibility of visiting our installations where you can see the fan manufacturing process, with the highest quality requirements, while we protect our environment by investing in energy efficiency.



**ENERGY SAVINGS**  
PROVIDED BY SYSTEMS  
EQUIPPED WITH  
EC TECHNOLOGY

**A great technological solution**  
that meets the new market requirements

Important **reduction** in energy costs.

Perfect **speed control**, by means of external sensors.

Helps fan **operation**.

These new products exceed the requirements of the ErP 2009/125/EC Ecodesign Directive and its regulating provisions (EU) 327/2011 for fans, and 1253/2014 for ventilation units, collaborating with the EU KYOTO Protocol objective of reducing CO<sub>2</sub> emissions.



## BENEFITS

- Energy saving of 70%, thanks to EC TECHNOLOGY and speed control
- Reduces energy costs
- Reduces environmental impact
- Low noise levels
- Balanced ventilation at all times
- Centralised installation and easy maintenance

Industrial EC TECHNOLOGY motors, with technology developed by SODECA, are designed to meet IE4 and IE5 efficiency standards. These units provide great energy savings and are equipped with the electronic systems required for operation as well as a variable speed drive (VSD) speed controller.



# EC TECHNOLOGY PLUG FAN

**7 SVE/PLUS/EW**  
Low noise in-line duct extractor fans mounted inside a 40 mm phonoabsorbent acoustic insulated casing



**14 SVE/PLUS/EW/CPC**  
In-line duct fans, automatic operation, low noise level and constant pressure control



**19 CL/PLUS/EC**  
In-line extract fans for rectangular ducts with a 40 mm thick acoustic casing to reduce noise and EC Technology motor



**24 CJK/EC**  
Ventilation units for circular ducts, with 25 mm acoustic insulation casing, interchangeable covers and EC Technology motor



**28 CJV/EW**  
Extract fans with automatic operation, vertical air outlet, EC Technology motor and constant pressure control for homes



**31 CRF/EW**  
Centrifugal rooftop fans with low noise level, equipped with EC Technology external rotor motor



**38 CRF/EW/CPC**  
Centrifugal roof fans, automatic operation, low noise level, EC Technology motor and constant pressure control



**43 HRE/EC**  
Circular axial fans with EC Technology outer rotor motor



**46 HCRE/EC**  
Wall mounted axial fans with EC Technology external rotor motor



**50 VENUS**  
High efficiency single zone heat recovery ventilators for residential installations



**53 REB**  
Heat recovery units with EC Technology motor and built-in by-pass



**56 REB-HEPA**  
Heat recovery units with EC Technology motor, built-in by-pass and HEPA filter



**58 RECUP/EC-BS**  
Heat recovery units with counter flow plate exchanger, automatic control and EC Technology motors, for installation in false ceilings



**63 RECUP/EC-H**  
Heat recovery units with counter flow exchanger, automatic control and EC Technology motors, for installation on a roof or in a plant room



**71 UPH/EC**  
Mobile air purifying units



**73 UPA**  
Units designed for cleaning and purifying indoor air. For use in areas of high occupancy, pharmaceutical industry and hospitals



**75 UPM/EC**  
Mobile air purifying units, designed for cleaning, odor removal and indoor air purification in any type of premises



**77 UPM/EC PCO**  
Mobile air purifying units with photocatalysis-based technology



**79 UPM/EC FE**  
Mobile air purifying units with high-efficiency electrostatic filters. For use in applications with greasy particles



**81 CJK/FILTER/EC**  
Air purifying units for circular ducts, 25 mm acoustic casing, EC Technology motor

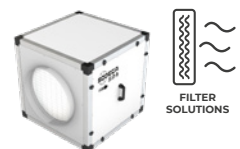

## IE4 AND IE5 EC TECHNOLOGY MOTOR

**86 HC/EC**  
Wall mounted axial fans, with EC Technology IE5 motor



**93 HCT/EC**  
Tubular axial fans, with EC Technology IE5 motor



**102 HFW/EC**  
Hot dip galvanized tubular axial fans, with EC Technology IE5 motor



**110 CBD/EC**  
Double inlet centrifugal fans, direct motor EC Technology IE4 with integrated electronics and forward curved impeller



**117 CBD/B/EC**  
Double inlet centrifugal fans, direct motor EC Technology IE4 with integrated electronics and without support feet



**119 CJBD/EC**  
Acoustically insulated ventilation units and EC Technology IE4 motor with integrated electronics



**121 CJBD/EC/CPC**  
Acoustically insulated ventilation units, EC Technology IE4 motor with integrated electronics and constant pressure control



**126 CJBD/EC/AL**  
Ventilation units with aluminum profiles and EC Technology IE4 motor with integrated electronics



**128 CJBD/EC/ALS**  
Ventilation units with aluminum profile, double insulating wall and EC Technology IE4 motor with integrated electronics



**130 CJBD/EC/C**  
Ventilation units with circular inlet and outlet and EC Technology IE4 motor with integrated electronics



**132 CMA/EC**  
Single inlet medium pressure centrifugal fans, casing and impeller in cast aluminum, and EC Technology IE5 motor



**136 CMP/EC**  
Single inlet medium pressure centrifugal fans, direct motor, forward curved impeller and EC Technology IE5 motor



**142 CRL/EC**  
Single inlet medium pressure centrifugal fans, backward curved impeller, IE5 EC Technology direct motor



**148 CPV/EC**  
Single inlet anti-corrosive centrifugal fans made of polypropylene, with EC Technology IE5 motor



**153 CKDR/EC**  
Extract units with large door and 40 mm acoustic insulation, equipped with EC Technology IE5 motor



**158 CJLINE/EC**  
Air extract units with linear inlet and outlet, equipped with EC Technology IE5 motor



**163 HT/EC**  
Axial rooftop fans with flat base, with EC Technology IE5 motor

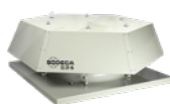

**170 CHT/EC**  
Centrifugal roof fans with horizontal air outlet, with EC Technology IE5 motor



**174 CVT/EC**  
Centrifugal roof fans with vertical air outlet, with EC Technology IE5 motor



## SENSORS AND CONTROLS FOR EC MOTORS

**178 EC CONTROL**  
Automatic regulation and control panel for ventilation systems with EC Technology motors



**180 CAP/EC**  
Intelligent control for the regulation of equipment with EC Technology fans prepared for external air quality probes



**181 SI-PM2.5+VOC**  
Intelligent probe for CAP/EC control, for the regulation of ventilation based on the parameters of solid particles and volatile organic compounds



**181 SI-CO2+VOC**  
Intelligent probe for CAP/EC control, for the regulation of ventilation based on CO2 and volatile organic compounds parameters



**182 MTP**  
Brushless motor speed control 0-10 V



# SVE/PLUS/EW



EC TECHNOLOGY WITH INTEGRATED VSD



**Low noise in-line duct extractor fans mounted inside a 40 mm phonoabsorbent acoustic insulated casing**



- Fan:**
- Acoustic casing covered with sound absorbing material.
  - All models equipped with a backward curved impeller.
  - Standardised inlet and outlet flanges allowing for easy installation in ducts.
  - Fitted with a folding inspection hatch.
  - Support feet integrated into the box which facilitates its assembly.
  - Linear airflow direction.
  - Adjustable speed via a built-in 10 k $\Omega$  potentiometer MTP010, or an external 0-10 V signal.

- Motor:**
- EC Technology external rotor motors with high efficiency and built-in variable speed drive controlled by 0-10 V signal.

- Single-phase 200-240 V 50/60 Hz, IP54 protection. Except SVE/PLUS/EW-400/H model, 200-277 V 50/60 Hz. IP55 protection.
- Maximum temperature of air to be carried: -25 °C +60 °C. Except model SVE/PLUS/EW-200/H, -25 °C +45 °C.

**Finish:**

- Anti-corrosive in galvanized steel sheet.



## Order code



## Technical characteristics

Model	Speed (r/min)	Maximum admissible current (A)	Max. electric power	Maximum flow rate	Sound pressure level at 50% of max. speed*	Approx. weight (Kg)	According ErP
		230V	(kW)	(m <sup>3</sup> /h)	dB (A)		
SVE/PLUS/EW-100/H	3570	1.01	0.120	399	38	11	2018
SVE/PLUS/EW-125/H	3570	1.01	0.120	480	36	11	2018
SVE/PLUS/EW-150/H	3570	1.01	0.120	498	33	11	2018
SVE/PLUS/EW-160/H	3570	1.01	0.120	534	31	11	2018
SVE/PLUS/EW-200/H	3265	1.35	0.176	948	36	14	2018
SVE/PLUS/EW-250/H	2850	1.35	0.180	1187	38	14	2018
SVE/PLUS/EW-315/H	1920	1.35	0.175	1430	29	23	2018
SVE/PLUS/EW-350/H	1460	1.45	0.190	1983	35	32	2018
SVE/PLUS/EW-400/H	1550	2.00	0.460	2856	38	39	2018

\* Irradiated sound pressure level in dB(A) at a distance of 1.5 m and at maximum flow rate.



## Erp. (Energy Related Products)

Information on Directive 2009/125/EC can be downloaded from the SODECA website or the QuickFan selector programme.

### Acoustic characteristics

Sound power spectrum Lw(A) in dB(A) per Hz frequency band  
Irradiated values at maximum speed and medium flow rate.

	63	125	250	500	1000	2000	4000	8000		63	125	250	500	1000	2000	4000	8000
SVE/PLUS/EW-100/H	38	43	45	47	49	53	47	43	SVE/PLUS/EW-250/H	46	44	43	45	55	35	34	30
SVE/PLUS/EW-125/H	37	43	45	48	50	53	48	44	SVE/PLUS/EW-315/H	30	44	33	32	44	25	24	19
SVE/PLUS/EW-150/H	32	42	41	51	44	44	44	40	SVE/PLUS/EW-350/H	37	50	40	42	36	29	26	14
SVE/PLUS/EW-160/H	33	43	42	47	45	46	45	41	SVE/PLUS/EW-400/H	37	52	41	42	34	29	27	27
SVE/PLUS/EW-200/H	50	50	43	50	44	42	45	45									

### Dimensions mm

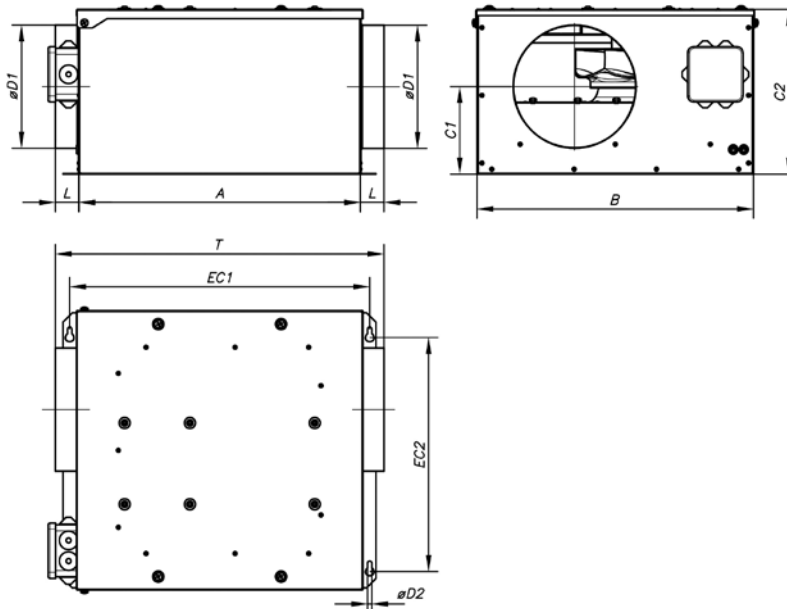

	A	B	C1	C2	øD1	L	øD2	EC1	EC2	T
SVE/PLUS/EW-100/H	380	380	174.5	255	100	37.5	7	405	305	455
SVE/PLUS/EW-125/H	380	380	164.5	255	125	37.5	7	405	305	455
SVE/PLUS/EW-150/H	380	380	160	255	150	37.5	7	405	305	455
SVE/PLUS/EW-160/H	380	380	155	255	160	37.5	7	405	305	455
SVE/PLUS/EW-200/H	460	450	140	265	200	37.5	7	485	380	535
SVE/PLUS/EW-250/H	460	450	165	310	250	52.5	7	485	380	565
SVE/PLUS/EW-315/H	565	540	210	390	315	57.5	9	595	440	680
SVE/PLUS/EW-350/H	650	600	265	465	350	57.5	9	680	525	765
SVE/PLUS/EW-400/H	650	680	280	500	400	80	9	680	600	810



### Characteristic curves

Q= Flow rate in m<sup>3</sup>/h, m<sup>3</sup>/s and cfm

Pe= Static pressure in mm H<sub>2</sub>O, Pa and inwg

#### SVE/PLUS/EW-100/H

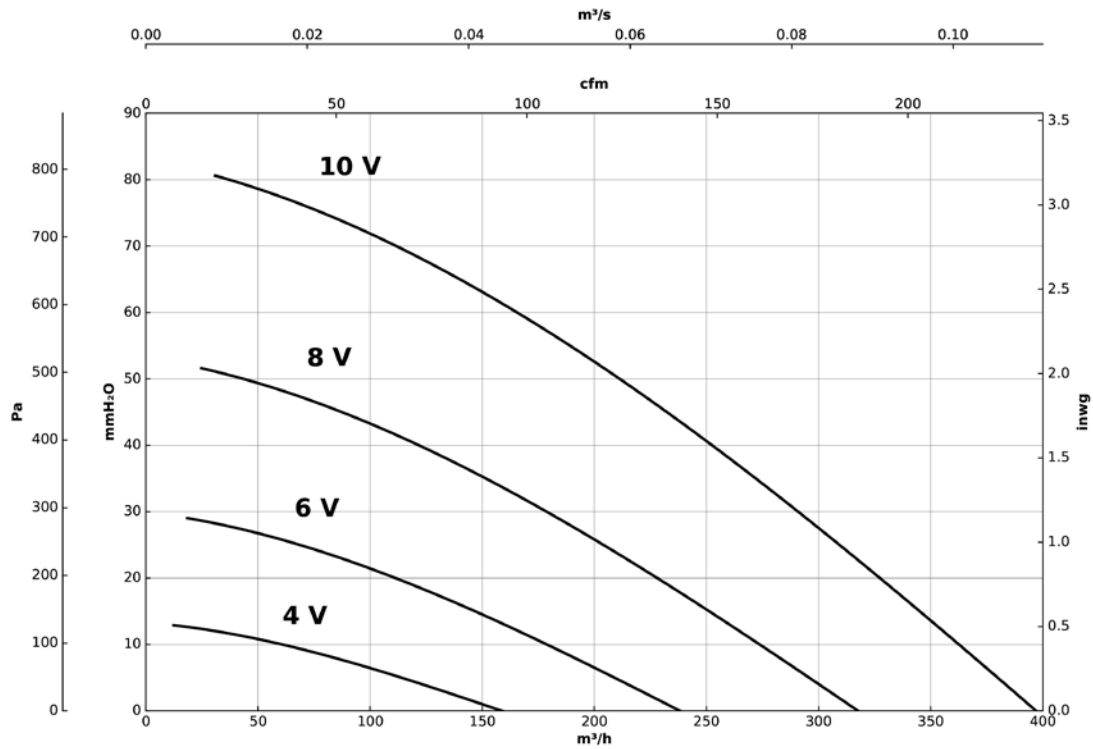

#### SVE/PLUS/EW-125/H

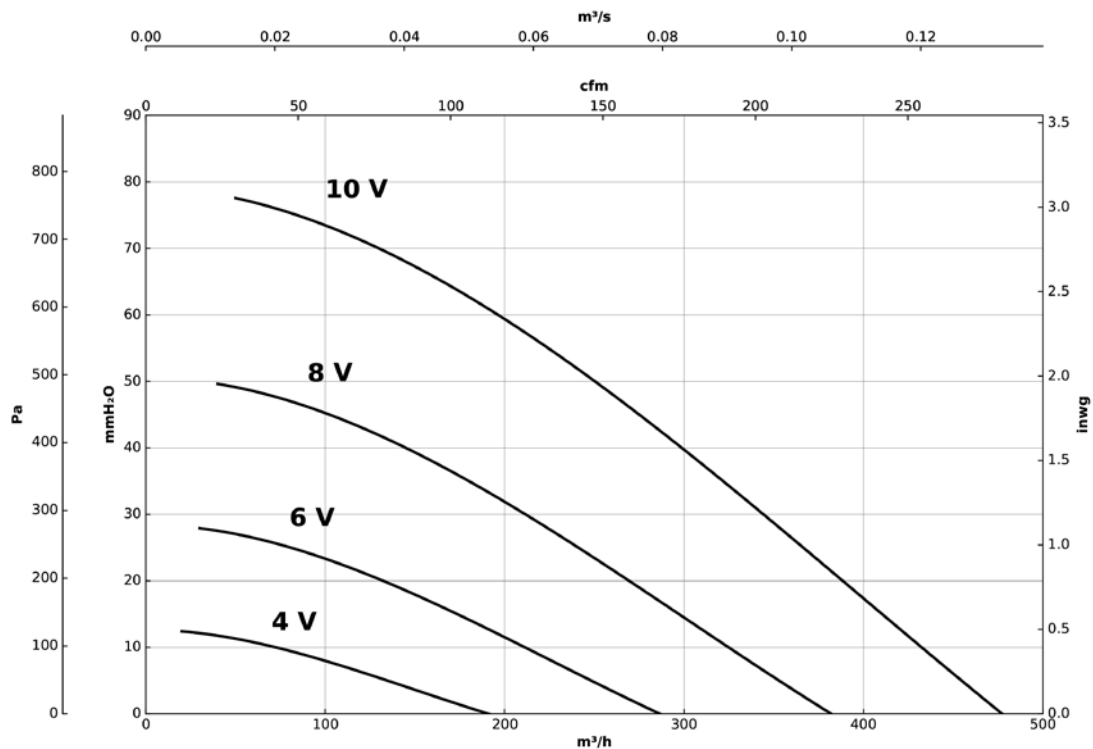

## Characteristic curves

Q= Flow rate in m<sup>3</sup>/h, m<sup>3</sup>/s and cfm

Pe= Static pressure in mm H<sub>2</sub>O, Pa and inwg

### SVE/PLUS/EW-150/H

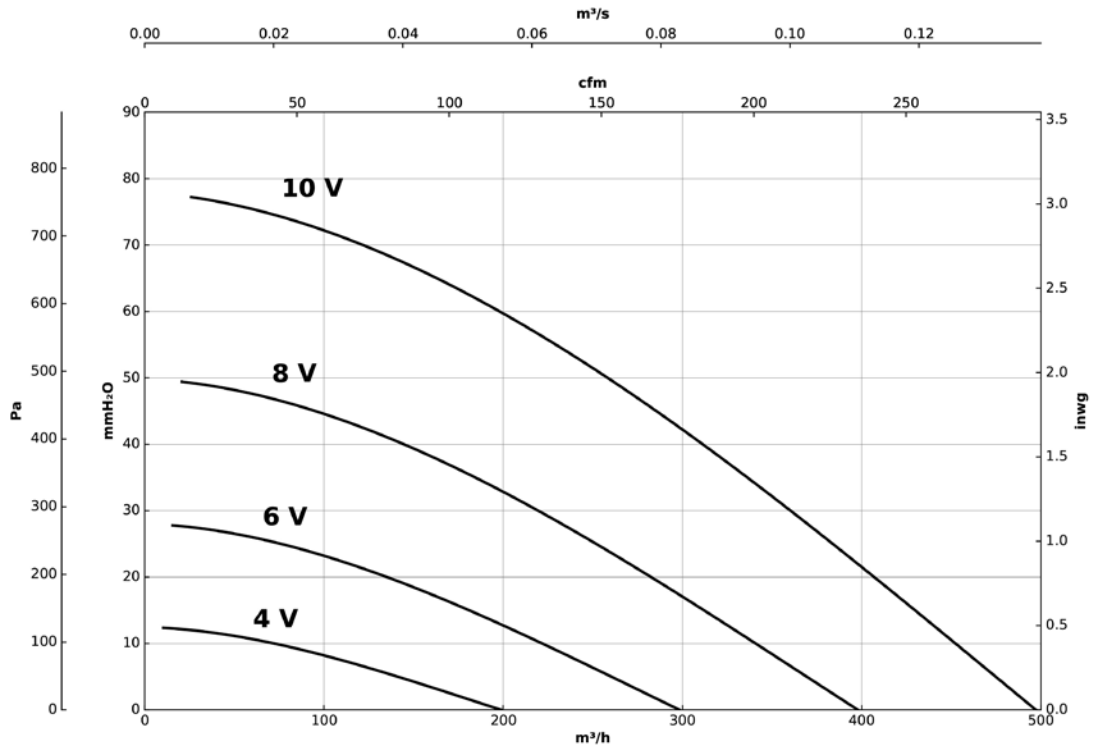

### SVE/PLUS/EW-160/H

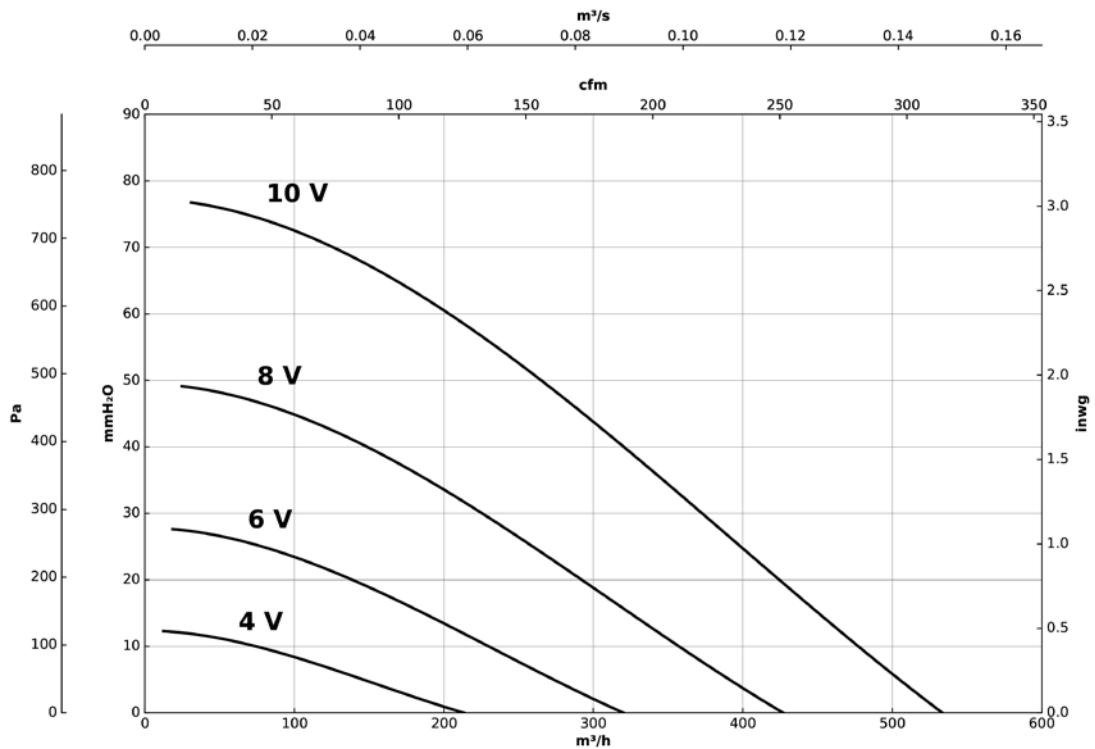

### Characteristic curves

Q= Flow rate in m<sup>3</sup>/h, m<sup>3</sup>/s and cfm

Pe= Static pressure in mm H<sub>2</sub>O, Pa and inwg

#### SVE/PLUS/EW-200/H

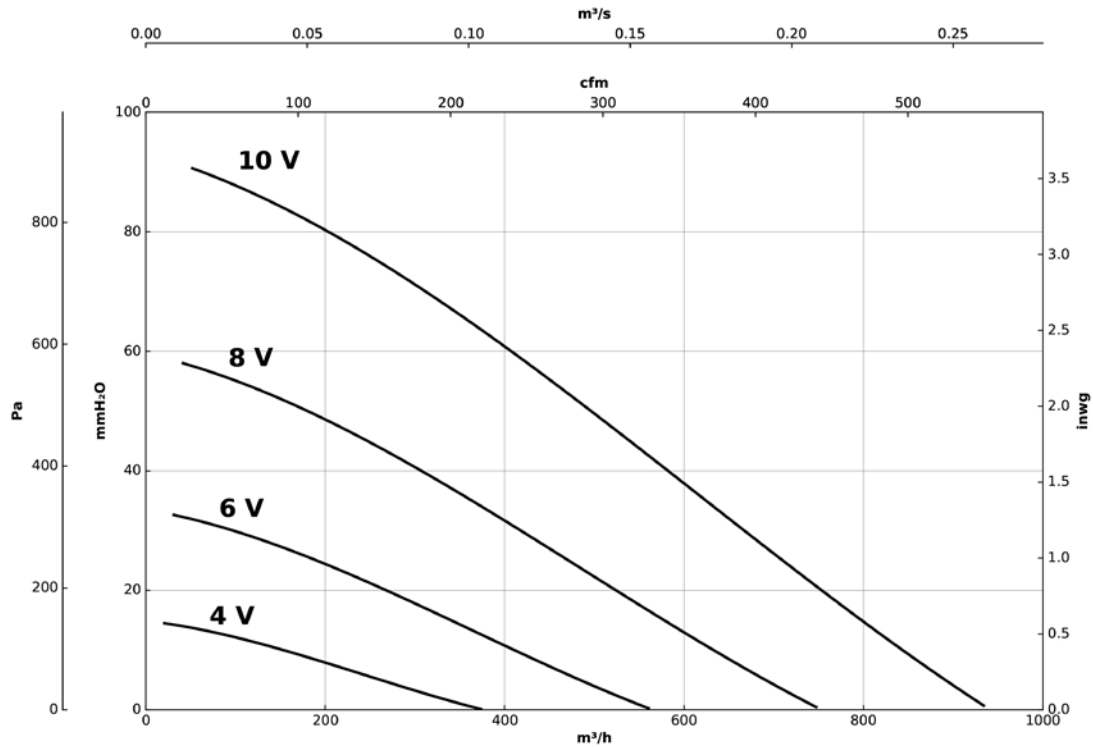

#### SVE/PLUS/EW-250/H

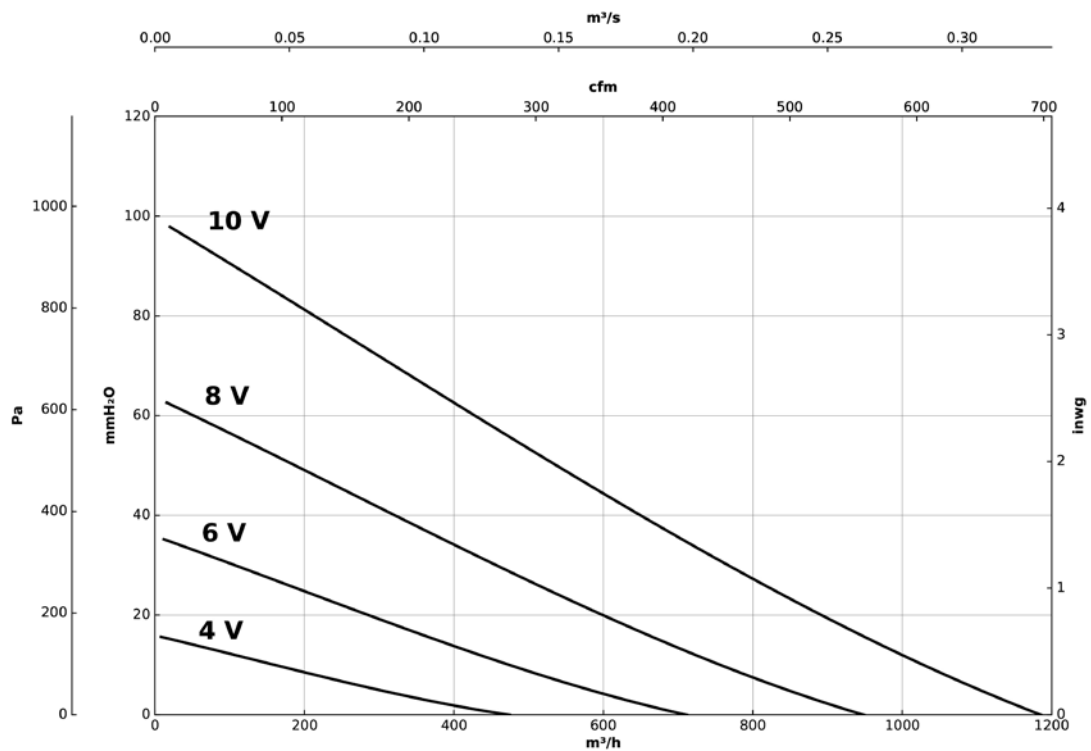

**Characteristic curves**

Q= Flow rate in m<sup>3</sup>/h, m<sup>3</sup>/s and cfm

Pe= Static pressure in mm H<sub>2</sub>O, Pa and inwg

**SVE/PLUS/EW-315/H**

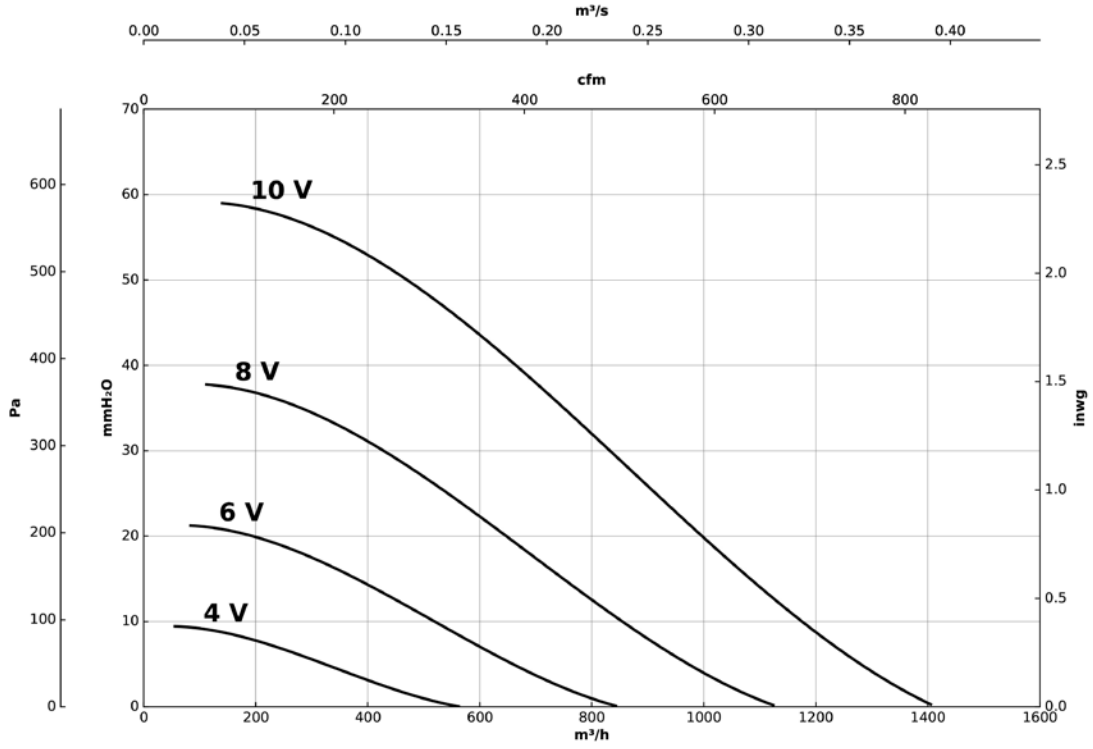

**SVE/PLUS/EW-350/H**

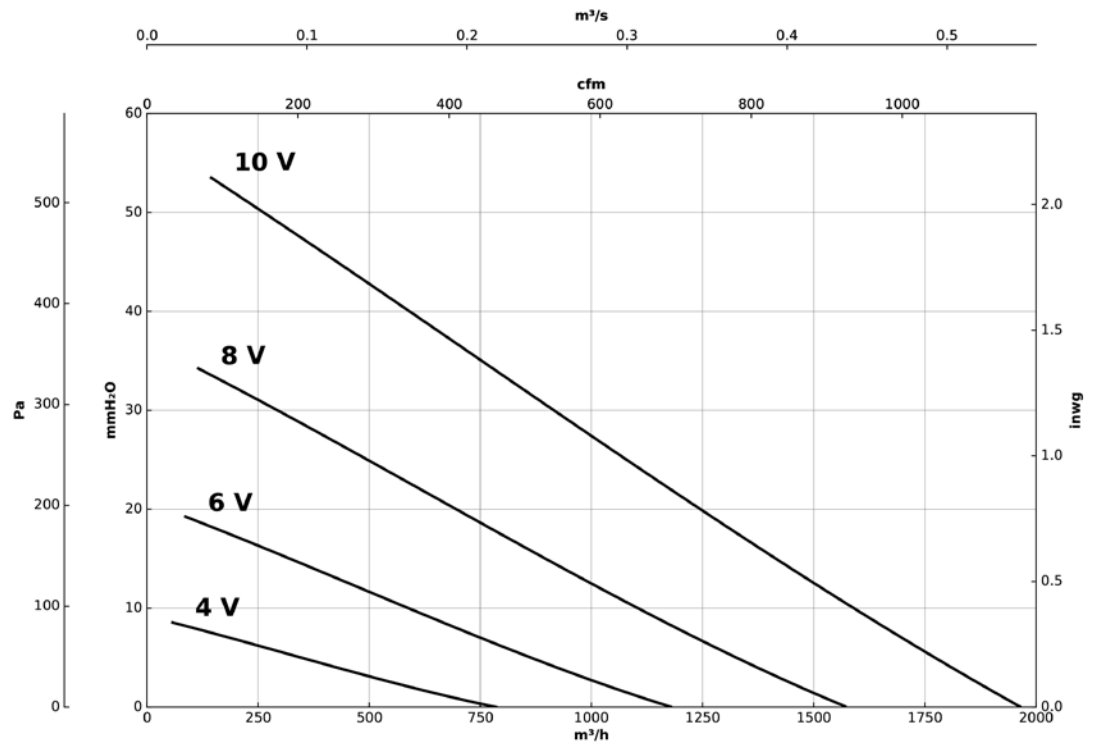

## Characteristic curves

Q= Flow rate in m<sup>3</sup>/h, m<sup>3</sup>/s and cfm

Pe= Static pressure in mm H<sub>2</sub>O, Pa and inwg

### SVE/PLUS/EW-400/H

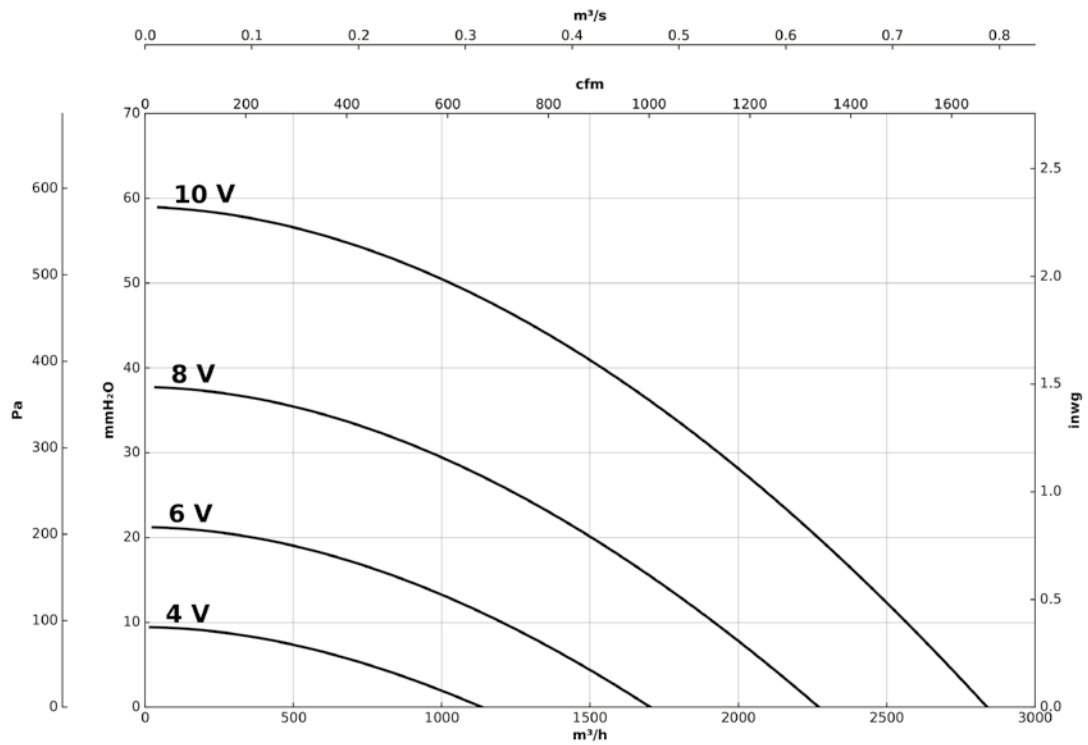

## Accessories



# SVE/PLUS/EW/CPC

*In-line duct fans, automatic operation, low noise level and constant pressure control*

EC TECHNOLOGY WITH INTEGRATED VSD



EC CONTROL:  
Automatic constant pressure regulation control

#### Fan:

- Acoustic casing covered with sound absorbing material.
- All models equipped with a backward curved impeller.
- Standardised inlet and outlet flanges allowing for easy installation in ducts.
- Fitted with a folding inspection hatch.
- Support feet integrated into the box which facilitates its assembly.
- Linear airflow direction.

#### Motor:

- Single-phase 200-240 V 50/60 Hz, IP54 protection. Except SVE/PLUS/EW-400/H model, 200-277 V 50/60 Hz. IP55 protection.
- Maximum temperature of air to be carried: -25 °C +60 °C. Except model SVE/PLUS/EW-200/H, -25 °C +45 °C.

- High efficiency external EC Technology motors.

EC CONTROL: Supplied as an optional accessory. Control panel for ventilation systems with EC Technology motors with the electronics integrated in the motor itself. With the following characteristics:

- CPC: Constant pressure control.
- CFC: Constant flow control.
- DAY/NIGHT: Double pressure setpoint adjustment according to time of day.
- External sensor: compatible with temperature, humidity, air quality or CO sensor.
- Equipment preconfigured in constant pressure mode with 100 Pa set point.

#### Finish:

- Anti-corrosive in galvanized steel sheet.

## Order code

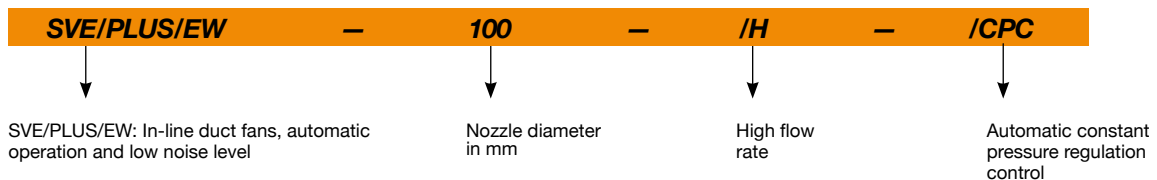

## Technical characteristics

Model	Speed (r/min)	Maximum admissible current (A)	Max. electric power	Maximum flow rate (m³/h)	Sound pressure level at 50% of max. speed* dB (A)	Approx. weight (Kg)	According ErP
		230V	(kW)				
SVE/PLUS/EW-100/H/CPC	3570	1.01	0.127	399	38	11	2018
SVE/PLUS/EW-125/H/CPC	3570	1.01	0.127	480	36	11	2018
SVE/PLUS/EW-150/H/CPC	3570	1.01	0.127	498	33	11	2018
SVE/PLUS/EW-160/H/CPC	3570	1.01	0.127	534	31	11	2018
SVE/PLUS/EW-200/H/CPC	3265	1.35	0.176	948	36	14	2018
SVE/PLUS/EW-250/H/CPC	2850	1.35	0.180	1187	38	14	2018
SVE/PLUS/EW-315/H/CPC	1920	1.35	0.175	1430	29	23	2018
SVE/PLUS/EW-350/H/CPC	1460	1.45	0.190	1983	35	32	2018
SVE/PLUS/EW-400/H/CPC	1550	2.00	0.460	2856	38	39	2018

\* Irradiated sound pressure level in dB(A) at a distance of 1.5 m and at maximum flow rate.

**Acoustic characteristics**

Sound power spectrum Lw(A) in dB(A) per Hz frequency band  
Irradiated values at maximum speed and medium flow rate.

	63	125	250	500	1000	2000	4000	8000
SVE/PLUS/EW-100/H/CPC	38	43	45	47	49	53	47	43
SVE/PLUS/EW-125/H/CPC	37	43	45	48	50	53	48	44
SVE/PLUS/EW-150/H/CPC	32	42	41	51	44	44	44	40
SVE/PLUS/EW-160/H/CPC	33	43	42	47	45	45	46	41
SVE/PLUS/EW-200/H/CPC	50	50	43	50	44	42	45	45
SVE/PLUS/EW-250/H/CPC	46	44	43	45	55	35	34	30
SVE/PLUS/EW-315/H/CPC	30	44	33	32	44	25	24	19
SVE/PLUS/EW-350/H/CPC	37	50	40	42	36	29	26	14
SVE/PLUS/EW-400/H/CPC	37	52	41	42	34	29	27	27

**Dimensions mm**

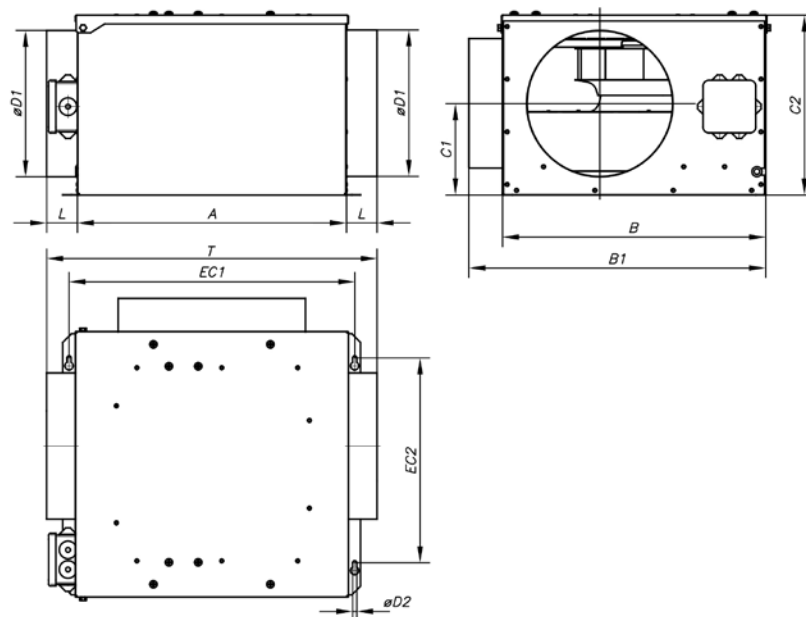

	A	B	C1	C2	øD1	L	øD2	EC1	EC2	T	B1
SVE/PLUS/EW-100/H/CPC	380	380	174.5	255	100	37.5	7	405	305	455	470
SVE/PLUS/EW-125/H/CPC	380	380	164.5	255	125	37.5	7	405	305	455	470
SVE/PLUS/EW-150/H/CPC	380	380	160	255	150	37.5	7	405	305	455	470
SVE/PLUS/EW-160/H/CPC	380	380	155	255	160	37.5	7	405	305	455	470
SVE/PLUS/EW-200/H/CPC	460	450	140	265	200	37.5	7	485	380	535	540
SVE/PLUS/EW-250/H/CPC	460	450	165	310	250	52.5	7	485	380	565	540
SVE/PLUS/EW-315/H/CPC	565	540	210	390	315	57.5	9	595	440	680	630
SVE/PLUS/EW-350/H/CPC	650	600	265	465	350	57.5	9	680	525	765	690
SVE/PLUS/EW-400/H/CPC	650	680	280	500	400	80	9	680	600	810	770

## Characteristic curves

Q= Flow rate in m<sup>3</sup>/h, m<sup>3</sup>/s and cfm

Pe= Static pressure in mm H<sub>2</sub>O, Pa and inwg

### SVE/PLUS/EW-100/H/CPC

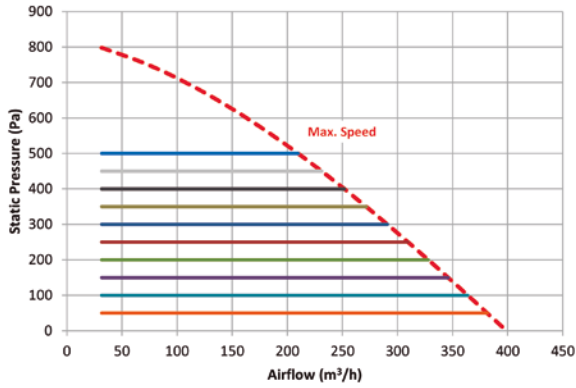

### SVE/PLUS/EW-125/H/CPC

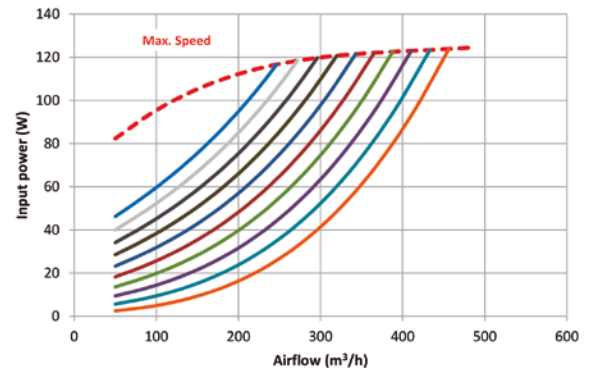
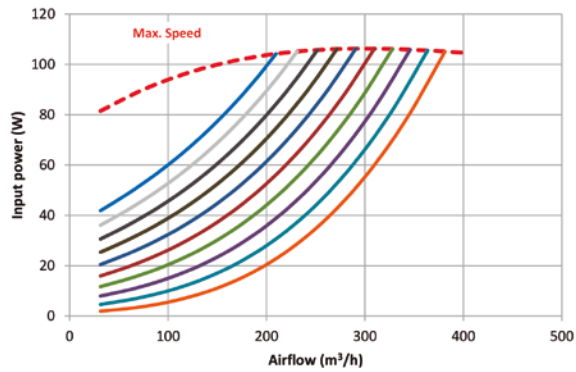
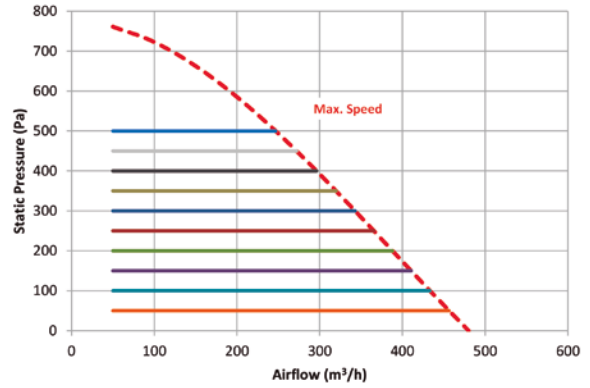

### SVE/PLUS/EW-150/H/CPC

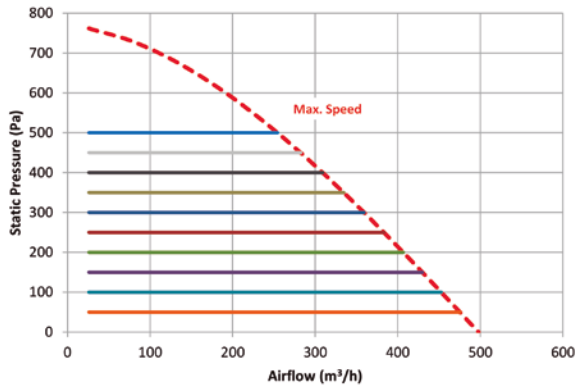

### SVE/PLUS/EW-160/H/CPC

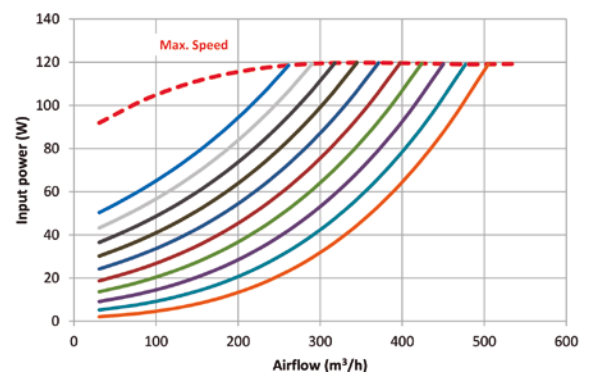
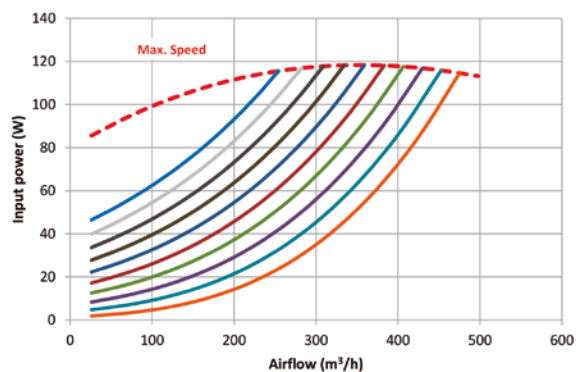
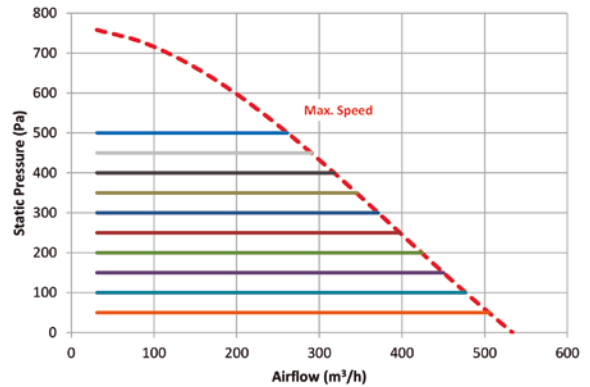



## Characteristic curves

Q= Flow rate in m<sup>3</sup>/h, m<sup>3</sup>/s and cfm

Pe= Static pressure in mm H<sub>2</sub>O, Pa and inwg

### SVE/PLUS/EW-200/H/CPC

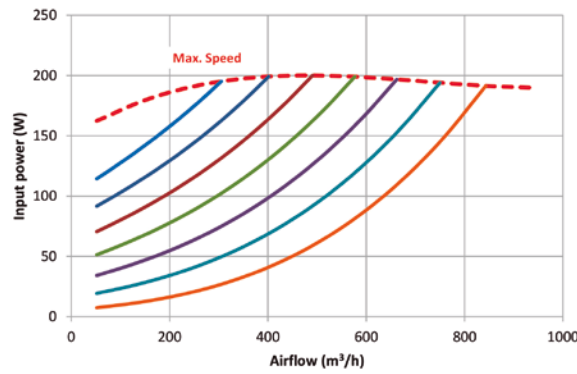
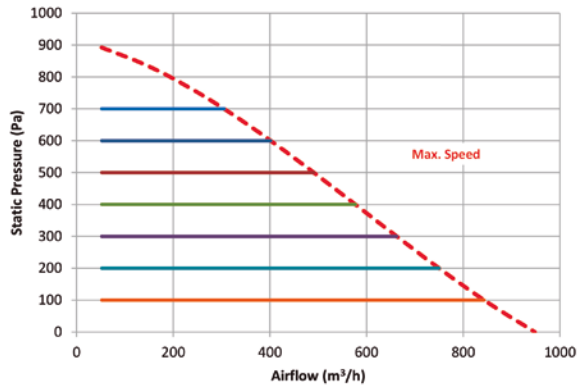

### SVE/PLUS/EW-250/H/CPC

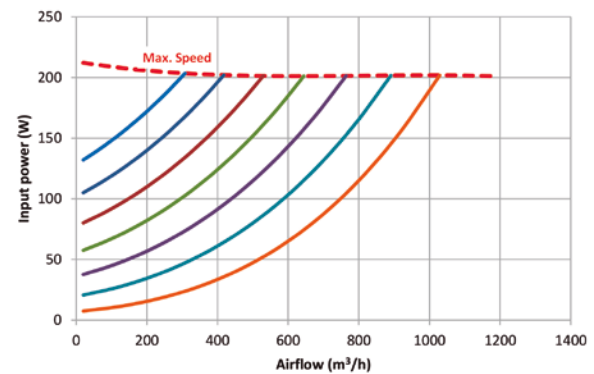
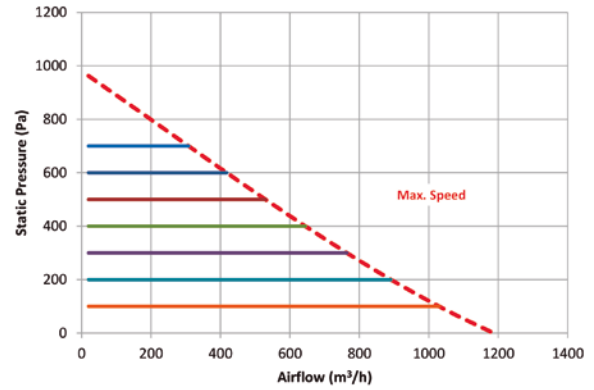

### SVE/PLUS/EW-315/H/CPC

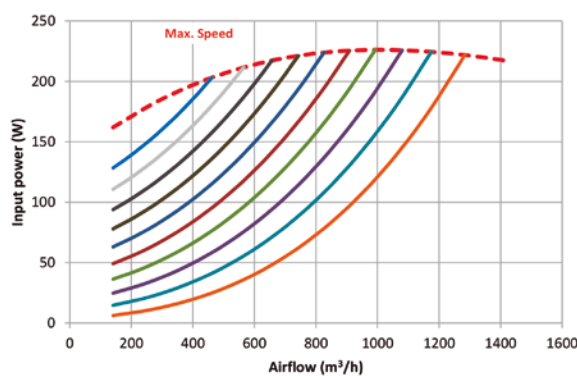
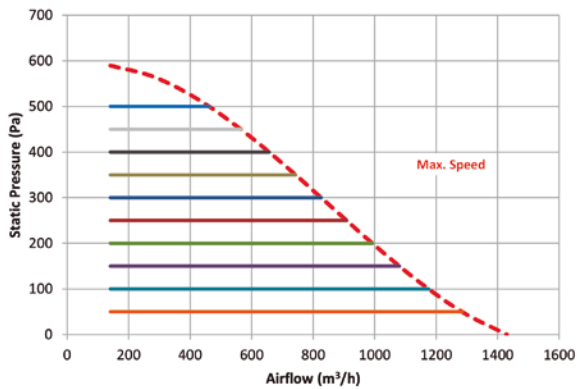

### SVE/PLUS/EW-350/H/CPC

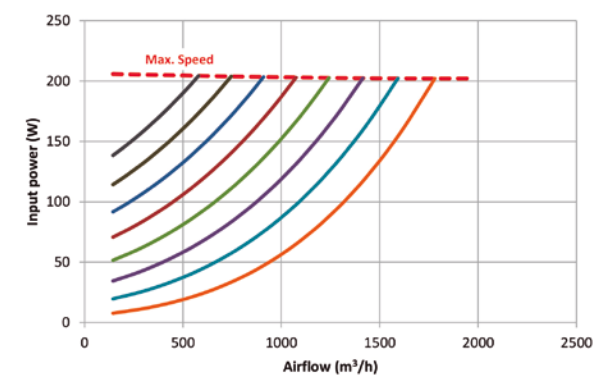
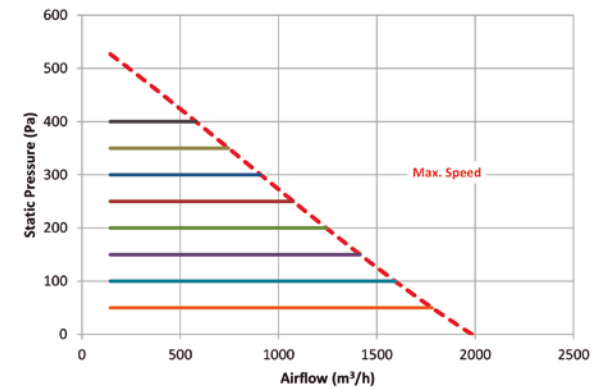

## Characteristic curves

Q= Flow rate in m<sup>3</sup>/h, m<sup>3</sup>/s and cfm

Pe= Static pressure in mm H<sub>2</sub>O, Pa and inwg

### SVE/PLUS/EW-400/H/CPC

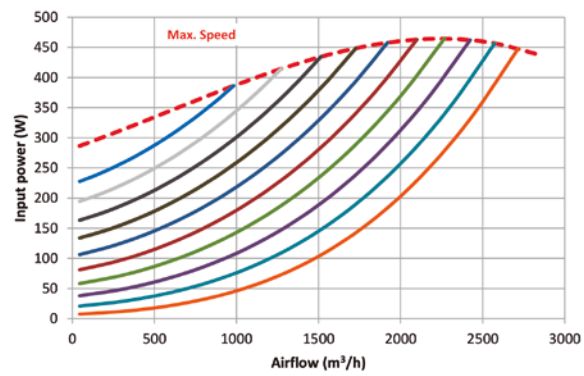
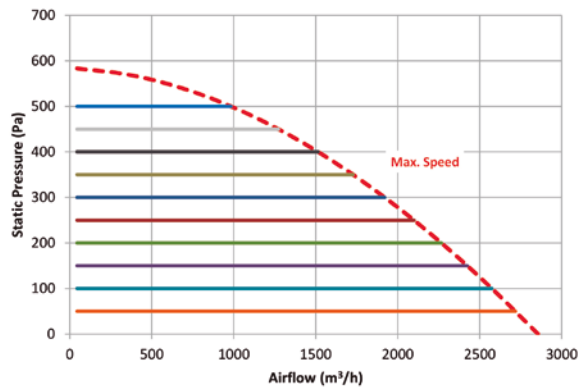

## Accessories



# CL/PLUS/EC



**In-line extract fans for rectangular ducts with a 40 mm thick acoustic casing to reduce noise and EC Technology motor**



#### Fan:

- Galvanized steel sheet casing.
- 40 mm acoustic insulation casing.
- Backward curved impeller.
- Linear airflow direction.
- Fitted with a folding inspection hatch for ease of maintenance.

- Single-phase 200-240 V 50/60 Hz and three-phase 380-480 V 50/60 Hz.
- Maximum temperature of air to be carried: -25 °C +60 °C.

#### Finish:

- Anti-corrosive in galvanized steel sheet.

#### Motor:

- High efficiency EC Technology motors, outer rotor adjustable via 0-10 V signal.

## Order code

**CL/PLUS/EC**

—

**5030**

CL/PLUS/EC: In-line extract fans for rectangular ducts with a 40 mm thick acoustic casing to reduce noise and EC Technology motor

Connection dimensions

## Technical characteristics

Model	Speed (r/min)	Maximum admissible current (A)		Max. electric power (W)	Maximum flow rate (m <sup>3</sup> /h)	Sound pressure level at 50% of max. speed* dB (A)	Approx. weight (Kg)	According ErP
		230V	400V					
CL/PLUS/EC-3015	3570	1.01		127	591	31	12	2018
CL/PLUS/EC-4020	3265	1.35		176	958	36	17	2018
CL/PLUS/EC-5030	1920	1.35		175	1964	29	26	2018
CL/PLUS/EC-6030	2377	2		450	2080	35	35	2018
CL/PLUS/EC-6035	1550	2		460	3450	38	39	2018
CL/PLUS/EC-7040	2000		1.68	950	5650	39	51	2018
CL/PLUS/EC-8050	1250		2	1150	7315	36	66	2018

\* Irradiated sound pressure level in dB(A) at a distance of 1.5 m and at maximum flow rate.



### Erp. (Energy Related Products)

Information on Directive 2009/125/EC can be downloaded from the SODECA website or the QuickFan selector programme.

### Accessories



MTP



INT



SI-CO2 IND



SI-TEMP IND



SI-TEMP+HUMEDAD



SI-HUMEDAD



SI-MF



SI-PRESION

## Acoustic characteristics

Sound power spectrum  $L_w(A)$  in dB(A) per Hz frequency band  
Irradiated values at maximum speed and medium flow rate.

	63	125	250	500	1000	2000	4000	8000		63	125	250	500	1000	2000	4000	8000
CL/PLUS/EC-3015	33	43	42	47	45	46	45	41		37	52	41	42	34	29	27	27
CL/PLUS/EC-4020	50	50	43	50	44	42	45	45		32	38	50	56	53	53	48	48
CL/PLUS/EC-5030	30	44	33	32	44	25	24	19		30	42	45	50	50	50	47	41
CL/PLUS/EC-6030	31	46	48	51	50	51	46	40									

## Dimensions mm

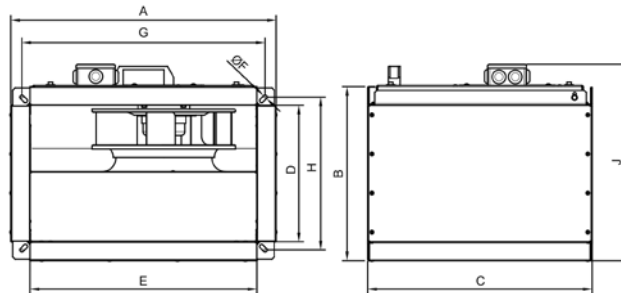

	A	B	C	D	E	øF	G	H	J
CL/PLUS/EC-3015	385	235	335	150	300	ø9	320	170	280
CL/PLUS/EC-4020	485	285	415	200	400	ø9	420	220	330
CL/PLUS/EC-5030	495	385	495	300	500	ø9	520	320	430
CL/PLUS/EC-6030	685	385	610	300	600	ø9	620	320	430
CL/PLUS/EC-6035	685	435	610	350	600	ø9	620	370	480
CL/PLUS/EC-7040	785	485	705	400	700	ø9	720	420	540
CL/PLUS/EC-8050	885	585	825	500	800	ø9	820	520	630

## Characteristic curves

Q= Flow rate in  $m^3/h$ ,  $m^3/s$  and cfm

Pe= Static pressure in mm H<sub>2</sub>O, Pa and inwg

### CL/PLUS/EC-3015

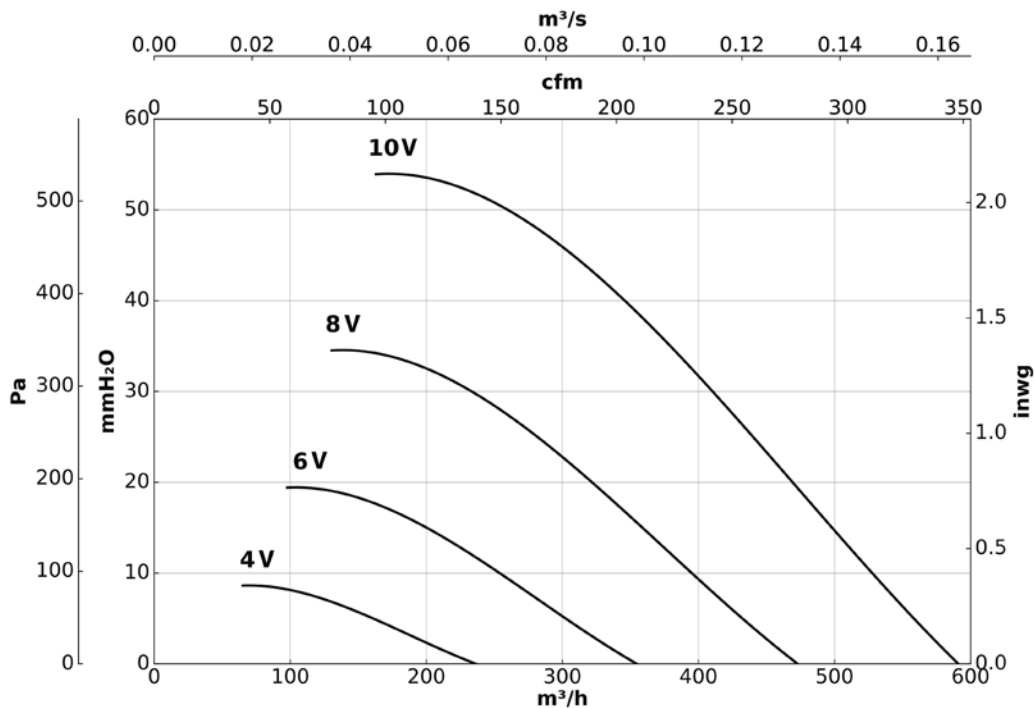

### Characteristic curves

Q= Flow rate in m<sup>3</sup>/h, m<sup>3</sup>/s and cfm

Pe= Static pressure in mm H<sub>2</sub>O, Pa and inwg

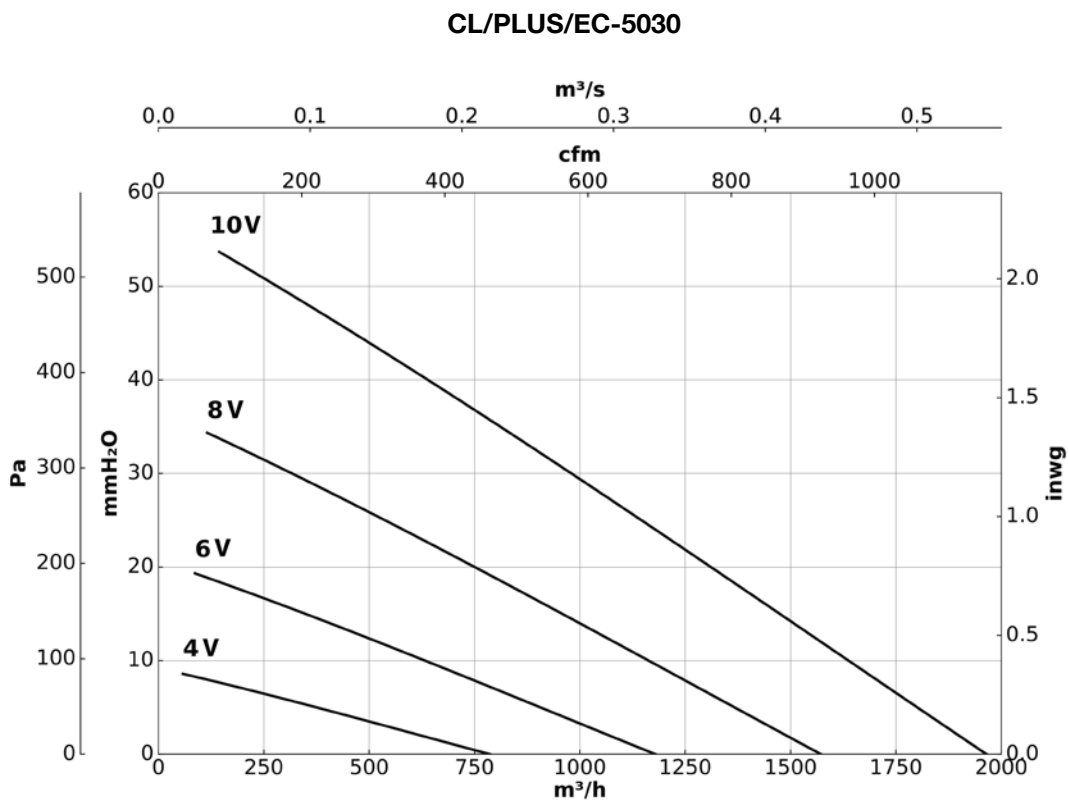
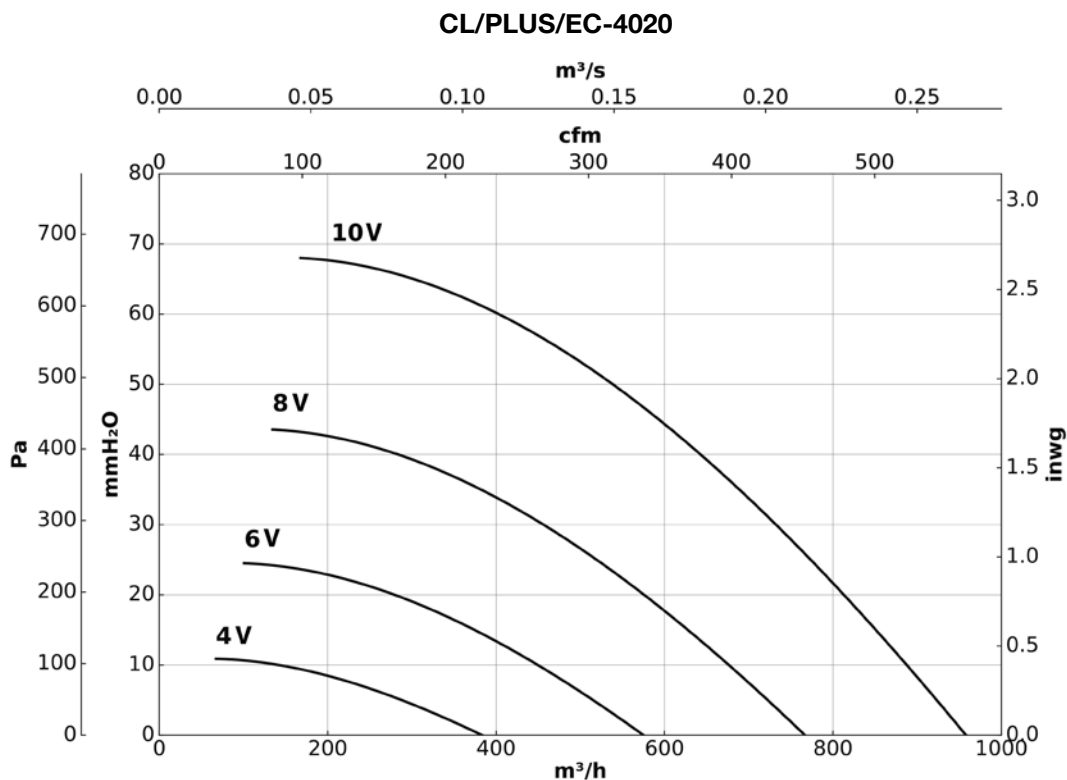

**Characteristic curves**

Q= Flow rate in m<sup>3</sup>/h, m<sup>3</sup>/s and cfm

Pe= Static pressure in mm H<sub>2</sub>O, Pa and inwg

**CL/PLUS/EC-6030**

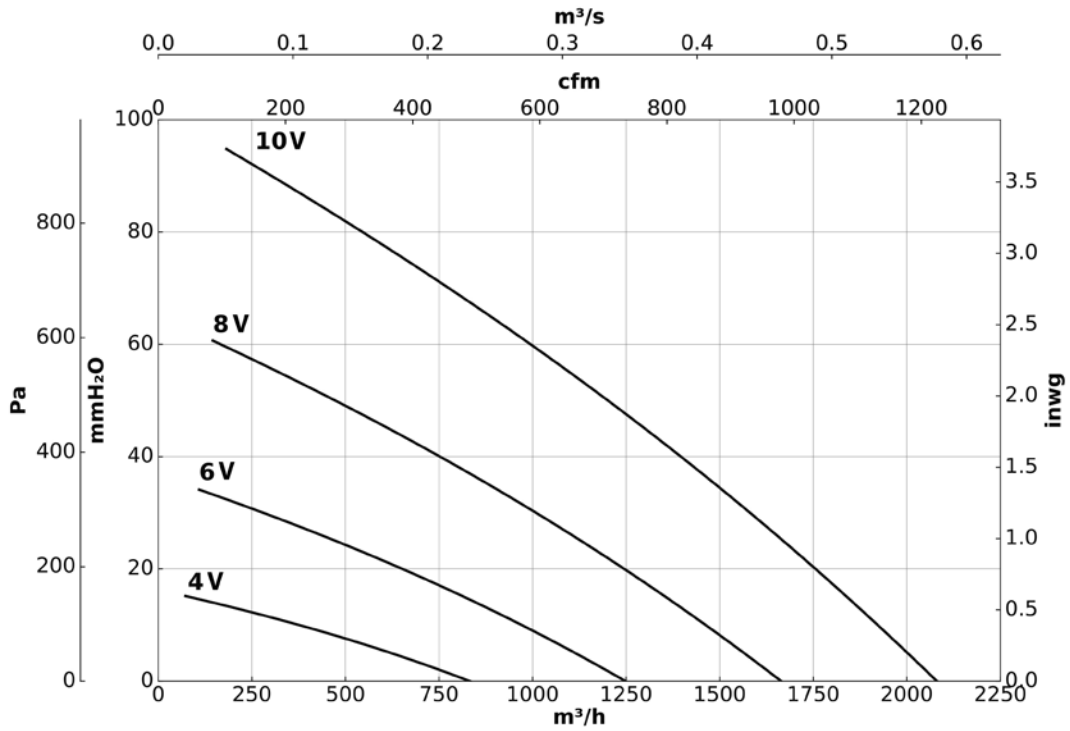

**CL/PLUS/EC-6035**

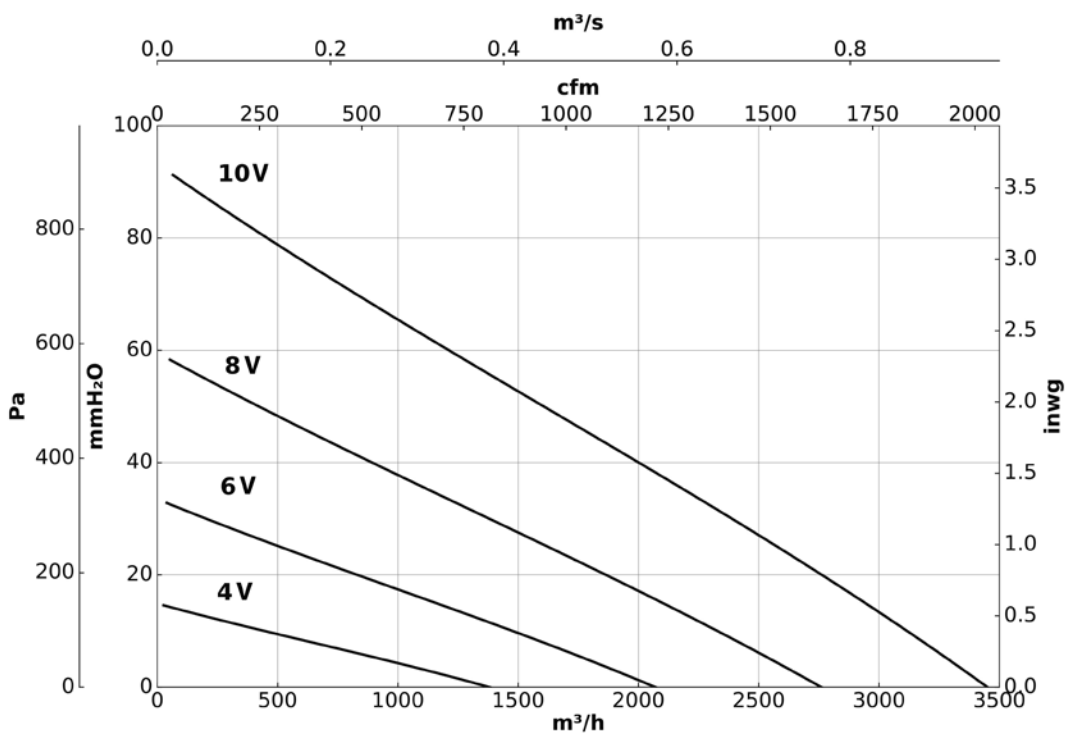

### Characteristic curves

Q= Flow rate in m<sup>3</sup>/h, m<sup>3</sup>/s and cfm

Pe= Static pressure in mm H<sub>2</sub>O, Pa and inwg

#### CL/PLUS/EC-7040

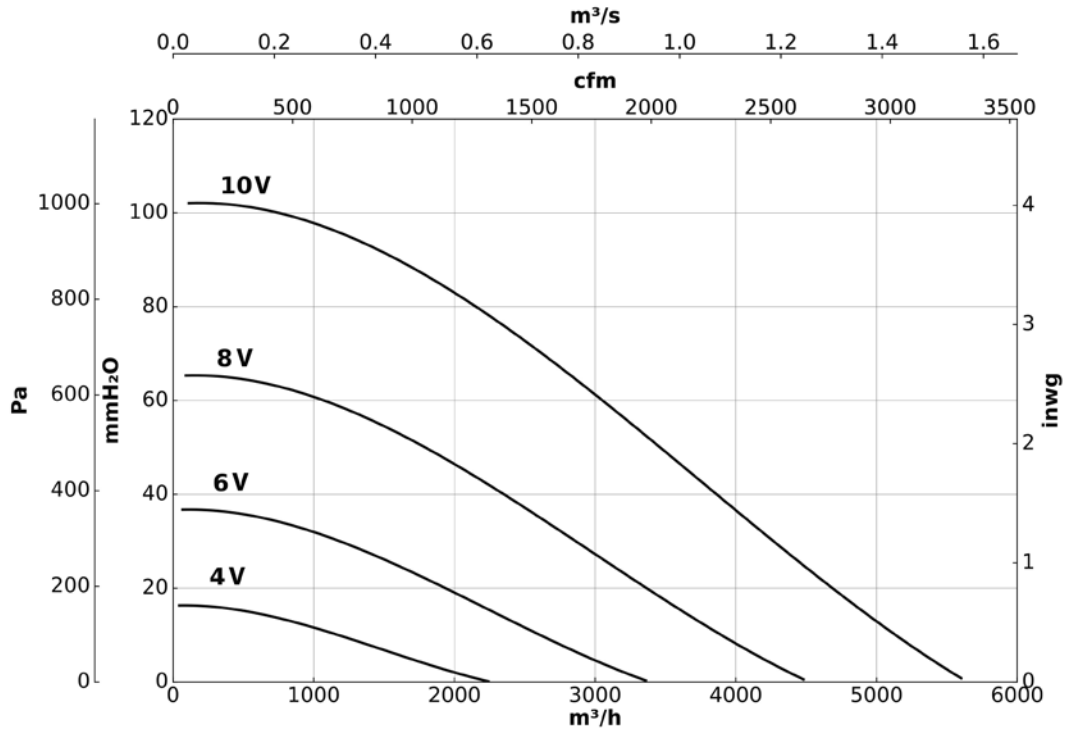

#### CL/PLUS/EC-8050

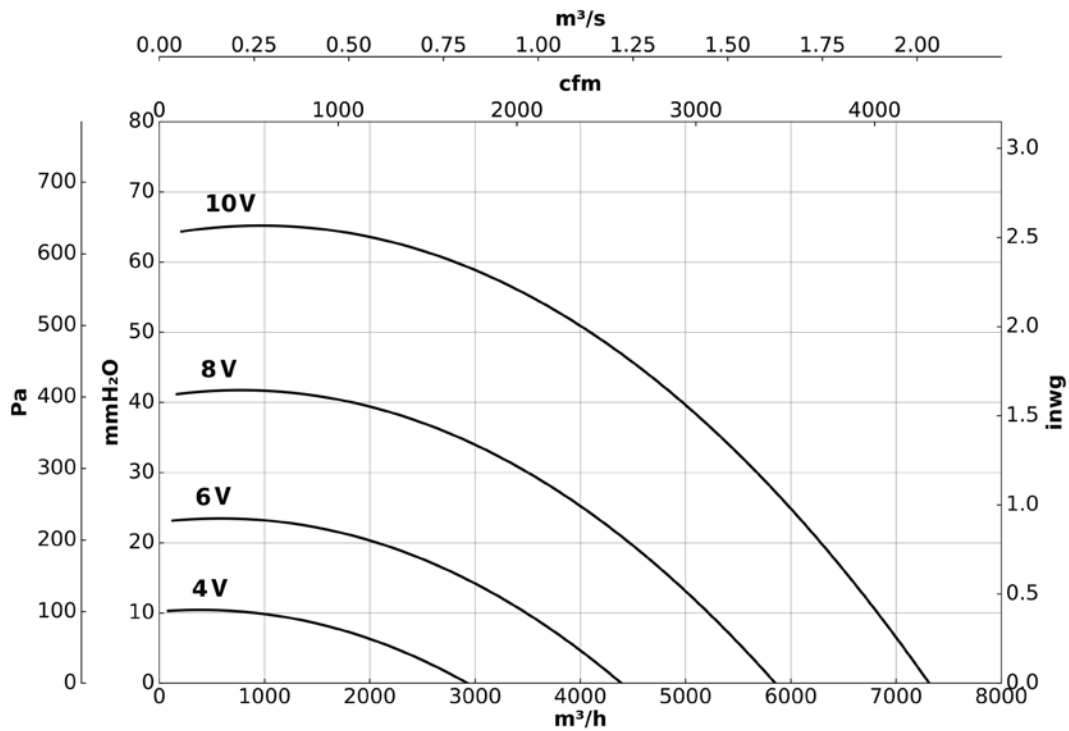

# CJK/EC



Ventilation units for circular ducts, with 25 mm acoustic insulation casing, interchangeable covers and EC Technology motor



#### Fan:

- Aluminium profile structure.
- Covers with a high quality, 25 mm thick acoustic casing made of prefinished sheet.
- Backward curved impeller.
- Standardised inlet and outlet flanges allowing for easy installation in ducts.
- Interchangeable covers to supply air on either side.
- Air inlet nozzle with diffusers that increase the efficiency of the fan.

#### Motor:

- High efficiency external rotor EC Technology motors, adjustable via 0-10 V signal.
- Single-phase 200-240 V 50/60 Hz and three-phase 380-480 V 50/60 Hz.
- Working temperature: -25 °C +60 °C.

#### Finish:

- Anti-corrosive in pre-lacquered steel sheet and aluminum profiles.

## Order code

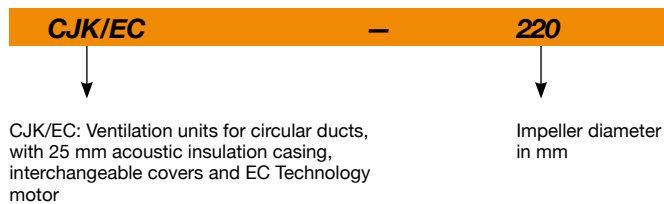

## Technical characteristics

Model	Speed (r/min)	Maximum admissible current (A)		Max. electric power (W)	Maximum flow rate (m <sup>3</sup> /h)	Sound pressure level at 50% of max. speed* dB (A)	Approx. weight (Kg)	According ErP
		230V	400V					
CJK/EC-220	3265	1.35		176	966	36	28	2018
CJK/EC-250	2850	1.35		180	1455	38	29	2018
CJK/EC-310	1920	1.35		175	1920	29	30	2018
CJK/EC-400	1550	2.00		460	3642	38	61	2018
CJK/EC-500	1250		2.00	1150	6577	36	106	2018

\* Irradiated sound pressure level in dB(A) at a distance of 1.5 m and at maximum flow rate.

## Accessories







## Erp. (Energy Related Products)

Information on Directive 2009/125/EC can be downloaded from the SODECA website or the QuickFan selector programme.

### Acoustic characteristics

Sound power spectrum  $L_w(A)$  in dB(A) per Hz frequency band  
Irradiated values at maximum speed and medium flow rate.

	63	125	250	500	1000	2000	4000	8000
CJK/EC-220	50	50	43	50	44	42	45	45
CJK/EC-250	46	44	43	45	55	35	34	30
CJK/EC-310	30	44	33	32	44	25	24	19
CJK/EC-400	37	52	41	42	34	29	27	27
CJK/EC-500	30	42	45	50	50	50	47	41

### Dimensions mm

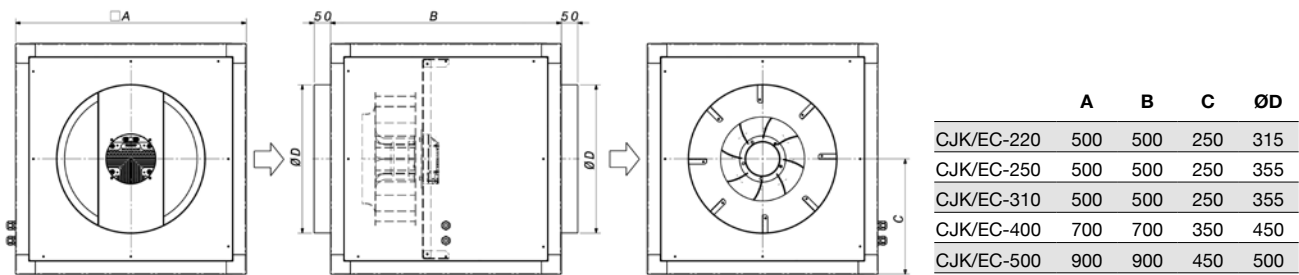

### Characteristic curves

Q= Flow rate in m<sup>3</sup>/h, m<sup>3</sup>/s and cfm

Pe= Static pressure in mm H<sub>2</sub>O, Pa and inwg

#### CJK/EC-220

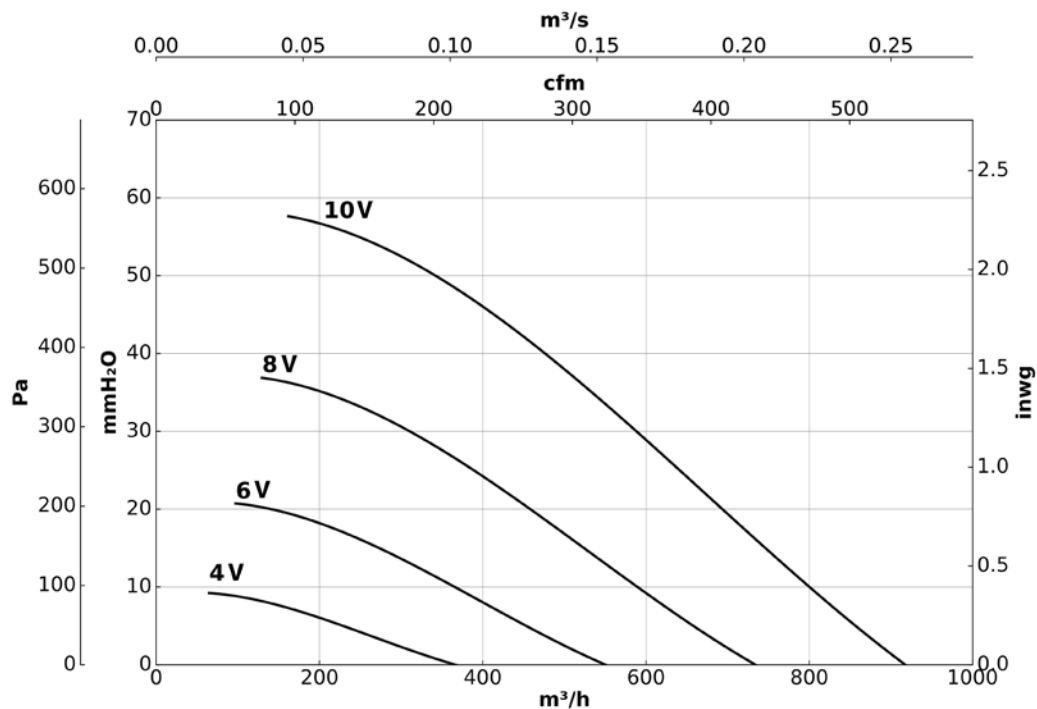

**Characteristic curves**

Q= Flow rate in m<sup>3</sup>/h, m<sup>3</sup>/s and cfm

Pe= Static pressure in mm H<sub>2</sub>O, Pa and inwg

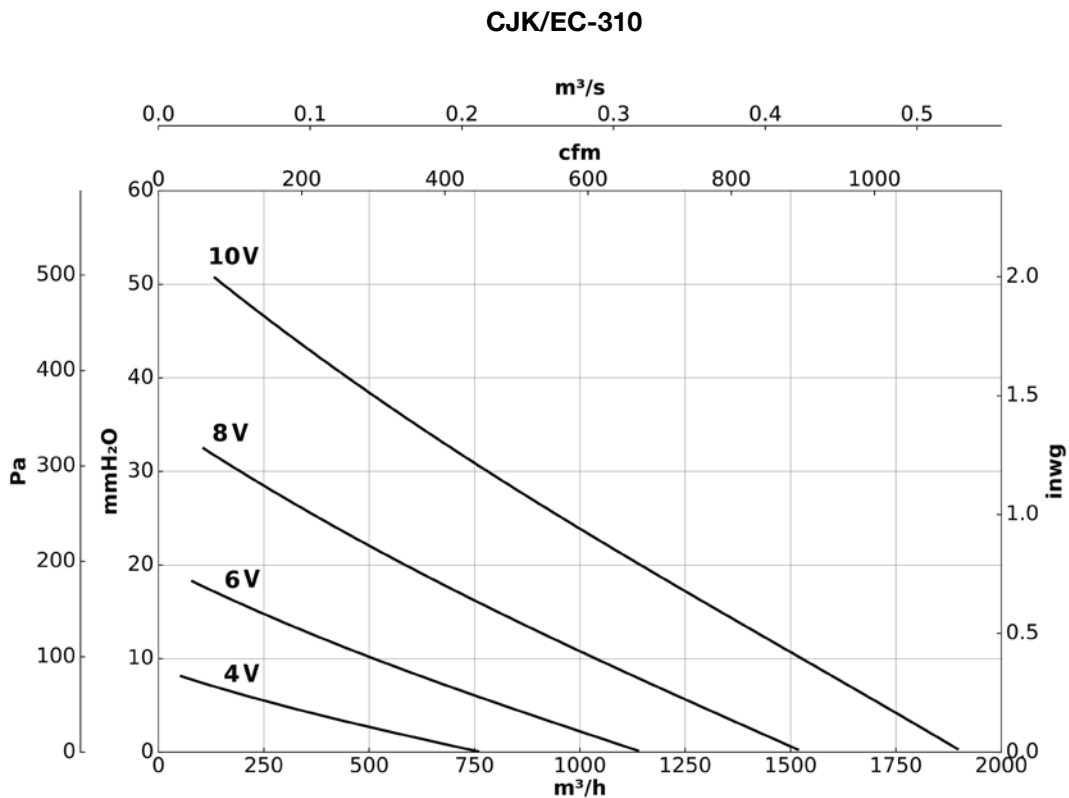
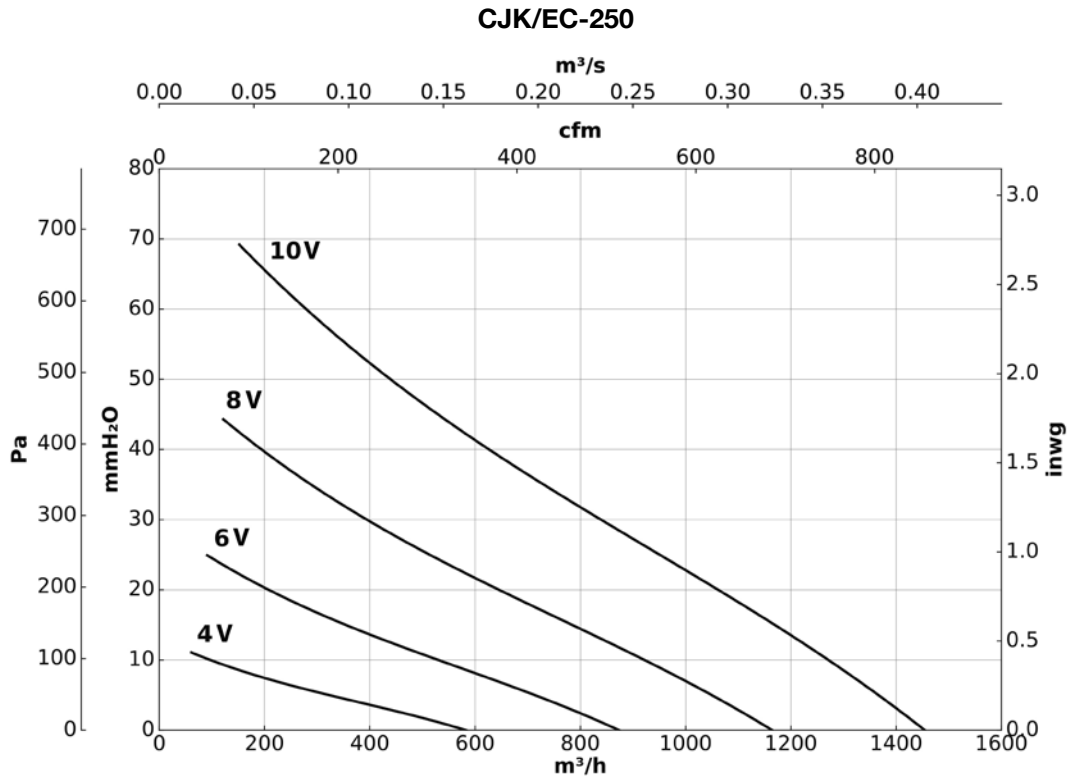

### Characteristic curves

Q= Flow rate in m<sup>3</sup>/h, m<sup>3</sup>/s and cfm

Pe= Static pressure in mm H<sub>2</sub>O, Pa and inwg

#### CJK/EC-400

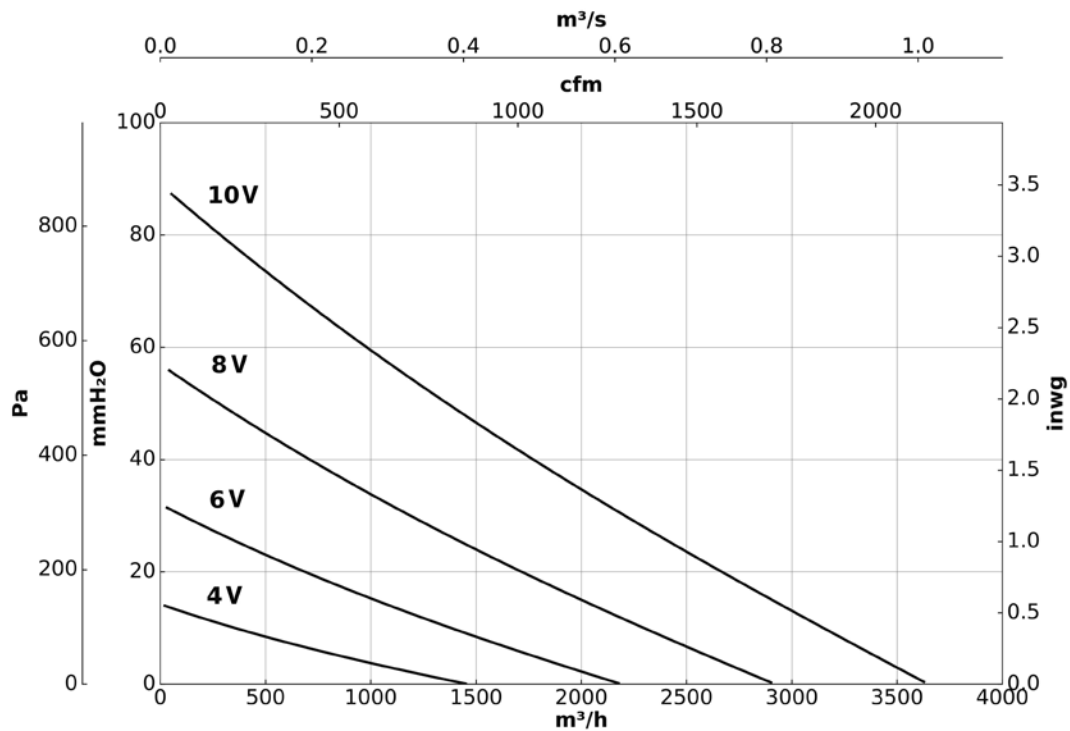

#### CJK/EC-500

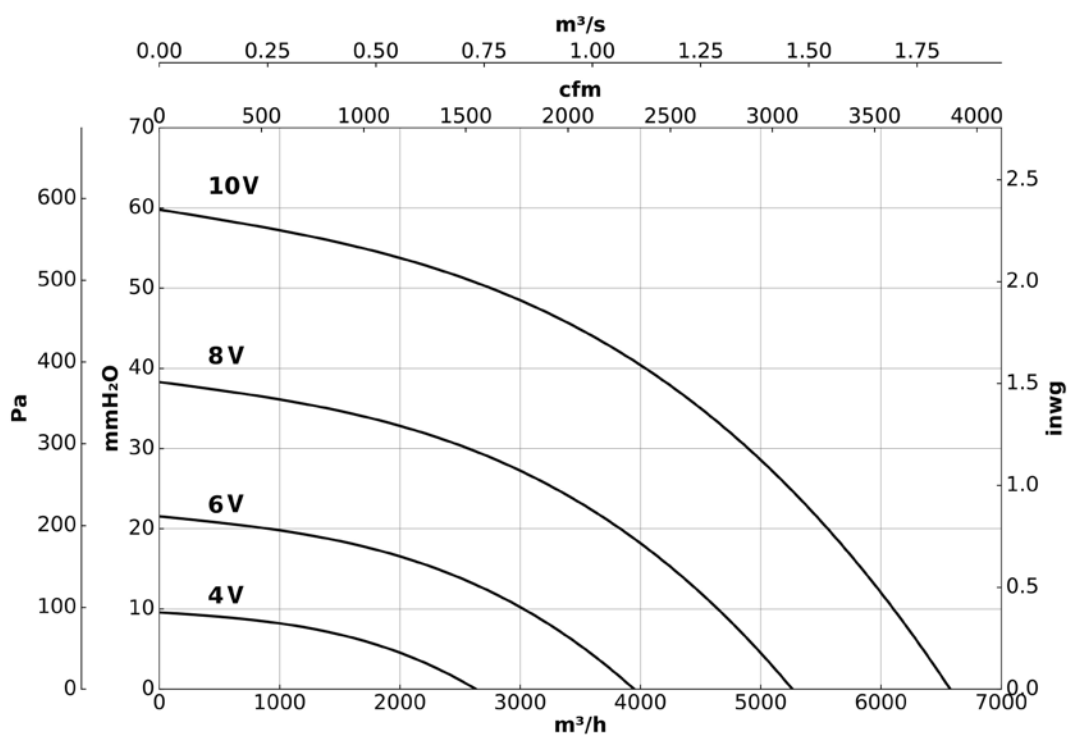

# CJV/EW



EC TECHNOLOGY WITH  
INTEGRATED VSD



**Extract fans with automatic operation, vertical air outlet, EC Technology motor and constant pressure control for homes**

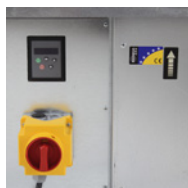

Model CJV/EW-1800/T  
approved for 400 °C/2h

#### Fan:

- Extraction units with vertical drive and two circular extraction mouths.
- Galvanized steel sheet casing.
- Forward curved impeller in galvanized sheet steel.
- Single-phase electronic speed drive (VSD), included with the fan.

#### Motor:

- New high-efficiency synchronous EC motors (IE4). Equipped with high intensity neodymium magnets.
- High reliability and maintenance free sensorless control.
- Fitted with long-life ball bearings.
- IP55 protection.
- Fan working temperature: -25 °C +60 °C.
- CJV/EW-1800/T: fan operating temperature: S1 -25°C +60 °C continuous operation. 400°C/2h S2 operation.
- Approved in accordance with standard EN 12101-3.

#### Electronic speed drive:

- Speed adjusted according to pressure setpoint.
- Automatic PI control built into the variable speed drive and differential pressure sensor.
- Drive parameters easily configurable through display and keypad.
- Supplied with safety ON/OFF switch, fully wired and ready to be installed.
- Available with single-phase input 220-240 V 50/60 Hz.
- Working temperature (VSD): -25 °C + 50 °C.

#### Finish:

- Anti-corrosive in galvanized steel sheet prepared to be installed outdoors.

#### On request:

- Fan with horizontal outlet.

## Technical characteristics

Model	Speed min/max (r/min)	Single-phase VSD 230 V 50/60 Hz	Max. electric power (W)	Sound pressure level min/max	Approx. weight (Kg)	According ErP
		Maximum current input (A)		Lp dB (A)		
CJV/EW-1800	300/1800	5.2	660	21 / 60	35	2018
CJV/EW-1800/T	300/1800	5.2	660	21 / 60	35	2018



### Erp. (Energy Related Products)

Information on Directive 2009/125/EC can be downloaded from the SODECA website or the QuickFan selector programme.

## Acoustic characteristics

Sound power spectrum Lw(A) in dB(A) per Hz frequency band  
Irradiated values at 1700 m<sup>3</sup>/h -250 Pa

	63	125	250	500	1000	2000	4000	8000
CJV/EW-1800	44	54	65	72	76	73	71	64
CJV/EW-1800/T	44	54	65	72	76	73	71	64

## Dimensions mm

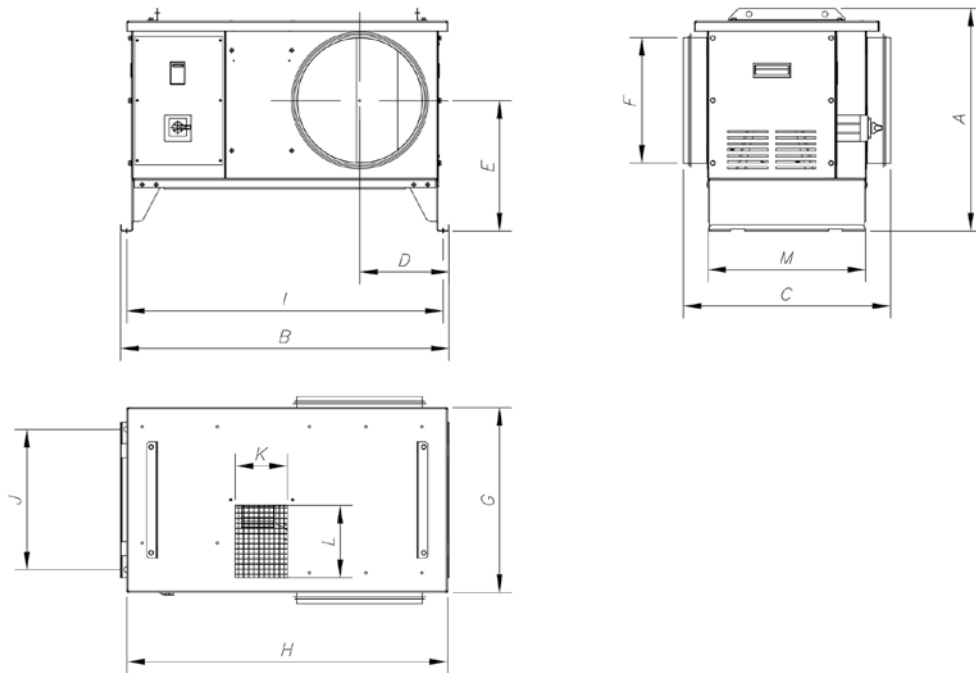

	A	B	C	D	E	F	G	H	I	J	K	L	M
CJV/EW-1800	560	815	520	225	325	315	460	800	780	345	130	180	395
CJV/EW-1800/T	560	815	520	225	325	315	460	800	780	345	130	180	395

## Accessories



## Characteristic curves

Flow rate in m<sup>3</sup>/h.    Static pressure in Pa.    Electric power in W.    Irradiated sound pressure at 4 m.

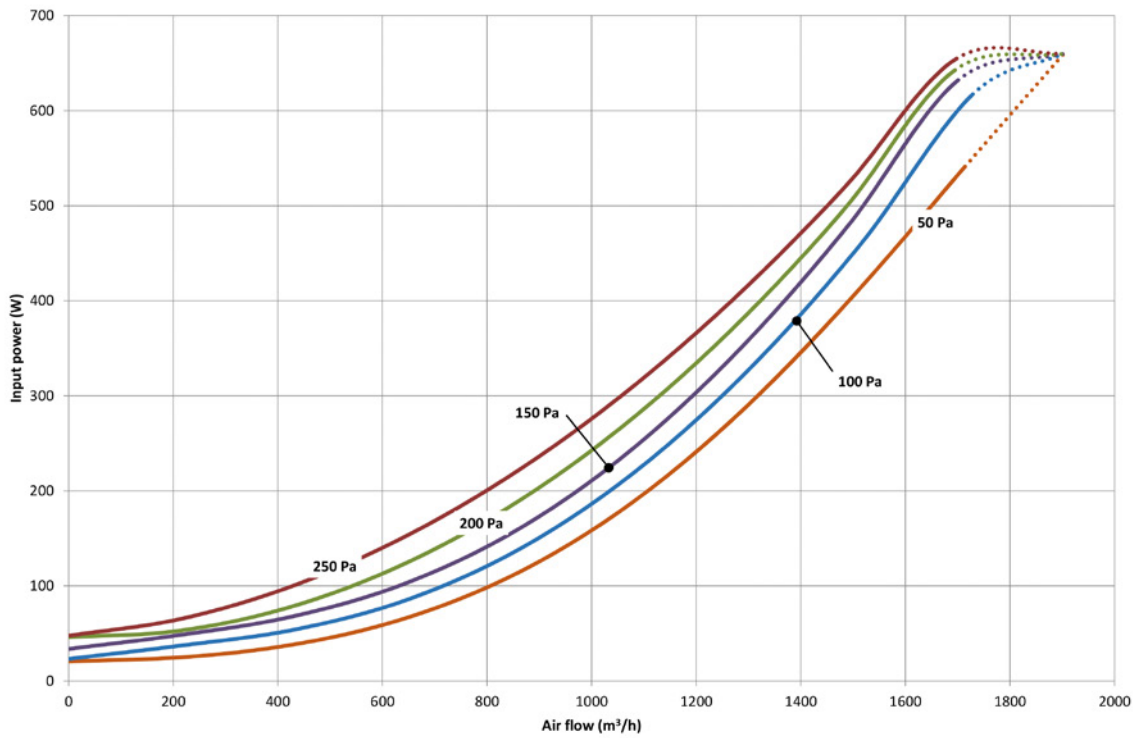
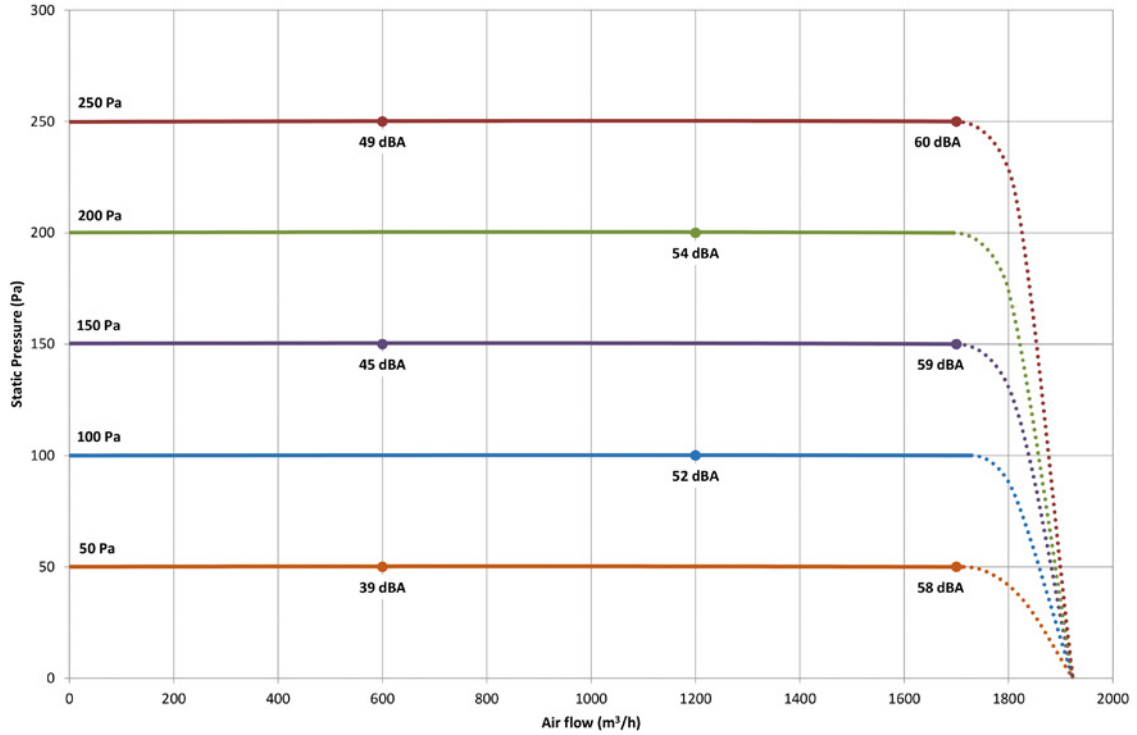

# CRF/EW

Centrifugal rooftop fans with low noise level, equipped with EC Technology external rotor motor



Roof-mounted centrifugal extractor fans with low noise level and external rotor motor. fitted with a EC Technology motor and a built-in speed regulating power meter.

- Single-phase 230 V 50/60 Hz and three-phase 400 V 50/60 Hz.
- Working temperature: -25 °C +50 °C.

Finish:

- Anti-corrosive in galvanized steel sheet.

Fan:

- Galvanized steel sheet construction.
- Backward curved impeller made of plastic material.
- Bird protection grid.
- Folding body for ease of inspection and maintenance.

Motor:

- New EC motors with external rotor, high efficiency and adjustable by means of a 0-10 V signal. IP54 protection.



## Order code

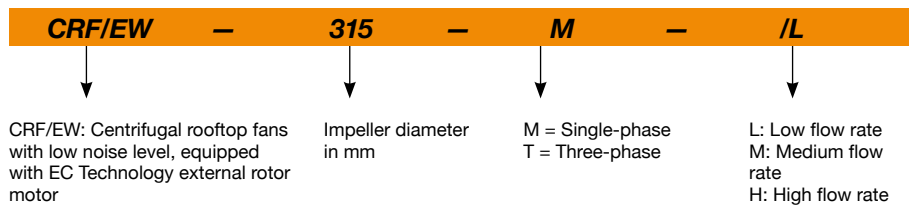

## Technical characteristics

Model	Max. speed (r/min)	Maximum admissible current (A)		Max. electric power (kW)	Maximum flow rate (m³/h)	NPS at maximum speed dB (A)*		Approx. weight (Kg)	According ErP
		230V	400V			Inlet	Exhaust		
CRF/EW-190-M	3570	1.01		0.127	718	42	45	10	2018
CRF/EW-250-M	2850	1.35		0.180	1553	44	47	12	2018
CRF/EW-315-M/L	1920	1.35		0.175	2223	35	38	16	2018
CRF/EW-315-M/H	2377	2.00		0.450	2597	49	52	18	2018
CRF/EW-400-M/M	1550	2.00		0.460	3811	45	48	27	2018
CRF/EW-400-M/H	1700	4.70		0.750	5202	49	52	28	2018
CRF/EW-400-T	2000		1.68	0.950	5573	51	58	29	2018
CRF/EW-500-M	1200	4.80		0.720	6831	43	49	48	2018
CRF/EW-500-T/L	1250		2.00	1.150	7401	48	54	50	2018

\* The noise level values are pressures in dB(A) measured at a distance of 6 metres and at 2/3 of the maximum flow rate (2/3 Qmax).



## Erp. (Energy Related Products)

Information on Directive 2009/125/EC can be downloaded from the SODECA website or the QuickFan selector programme.

### Acoustic characteristics

Sound power spectrum Lw(A) in dB(A) per Hz frequency band

Values measured at inlet with 2/3 maximum flow rate (2/3 Qmax).

	63	125	250	500	1000	2000	4000	8000
190-M	28	45	51	58	60	61	57	52
250-M	34	49	55	60	62	61	59	50
315-M/L	29	51	48	53	53	51	47	40
315-M/H	46	61	63	66	65	66	61	55
400-M/M	46	60	57	63	61	59	54	57
400-M/H	39	63	62	68	65	63	58	60
400-T	40	53	65	71	68	68	63	63
500-M	41	55	56	60	62	61	57	50
500-T/L	45	57	60	65	65	65	62	56

Values measured at exhaust with 2/3 maximum flow rate (2/3 Qmax).

	63	125	250	500	1000	2000	4000	8000
190-M	31	48	54	61	63	64	60	55
250-M	37	52	58	63	65	64	62	53
315-M/L	32	54	51	56	56	54	50	43
315-M/H	49	64	66	69	68	69	64	58
400-M/M	49	63	60	66	64	62	57	60
400-M/H	42	66	65	71	68	66	61	63
400-T	45	56	68	73	78	76	70	66
500-M	43	56	59	67	69	65	59	53
500-T/L	46	59	63	71	75	69	65	59

### Dimensions mm

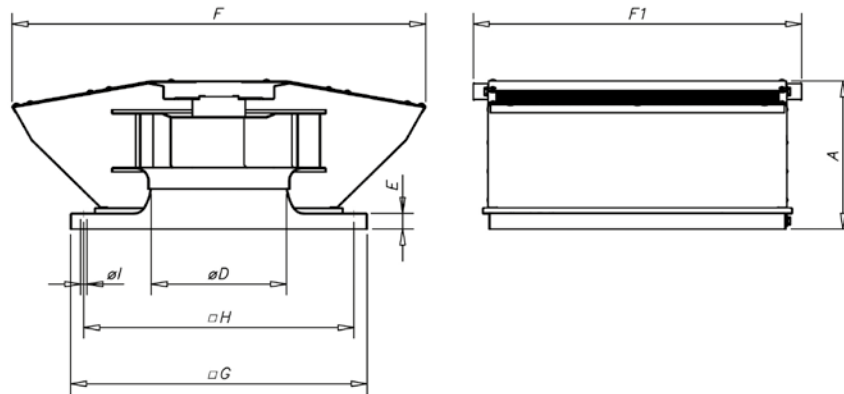

	A	ØD*	E	F	F1	G	H	øI
CRF/EW-190	185	124	30	477	420	355	305	12
CRF/EW-250	190	165	30	518	465	400	350	12
CRF/EW-315	277	204	30	701	515	450	400	12
CRF/EW-400	365	257	30	850	622	560	510	12
CRF/EW-500	426	321	30	1137	775	710	660	12

\* Recommended nominal tube diameter

### Accessories



INT



RM



PA

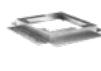

MS



PT



SI-CO2 IND



SI-TEMP IND



SI-TEMP+HUMEDAD



SI-HUMEDAD



SI-MF



SI-PRESIÓN



### Characteristic curves

Q= Flow rate in m<sup>3</sup>/h, m<sup>3</sup>/s and cfm

Pe= Static pressure in mm H<sub>2</sub>O, Pa and inwg

#### CRF/EW-190-M

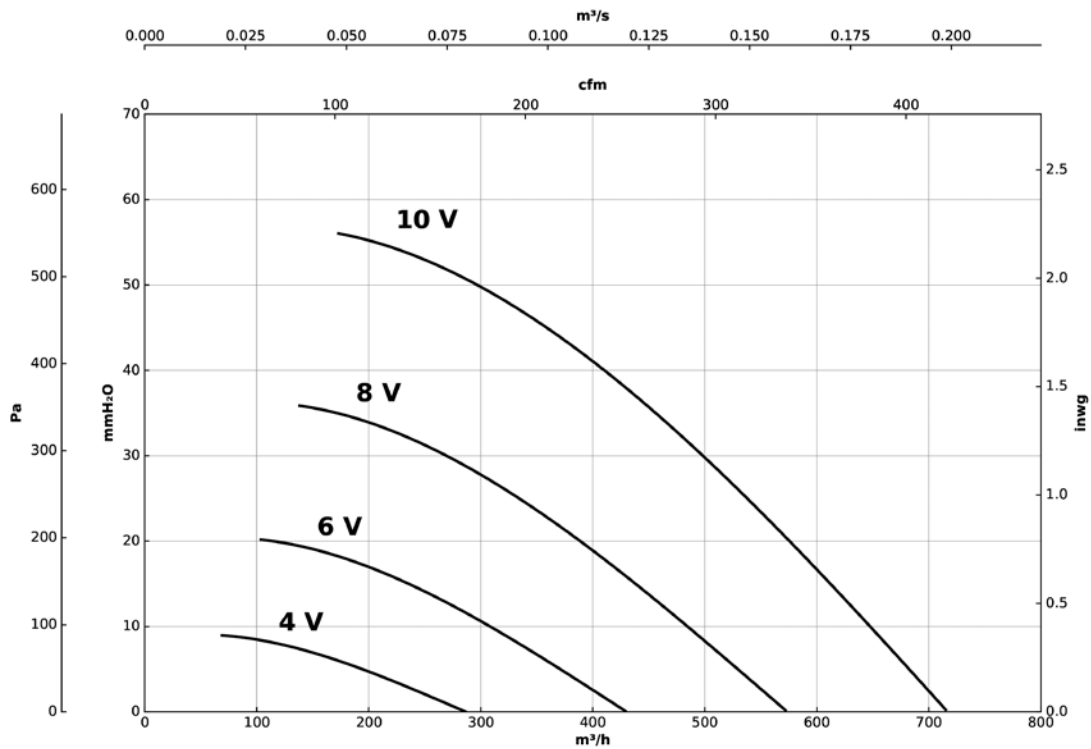

#### CRF/EW-250-M

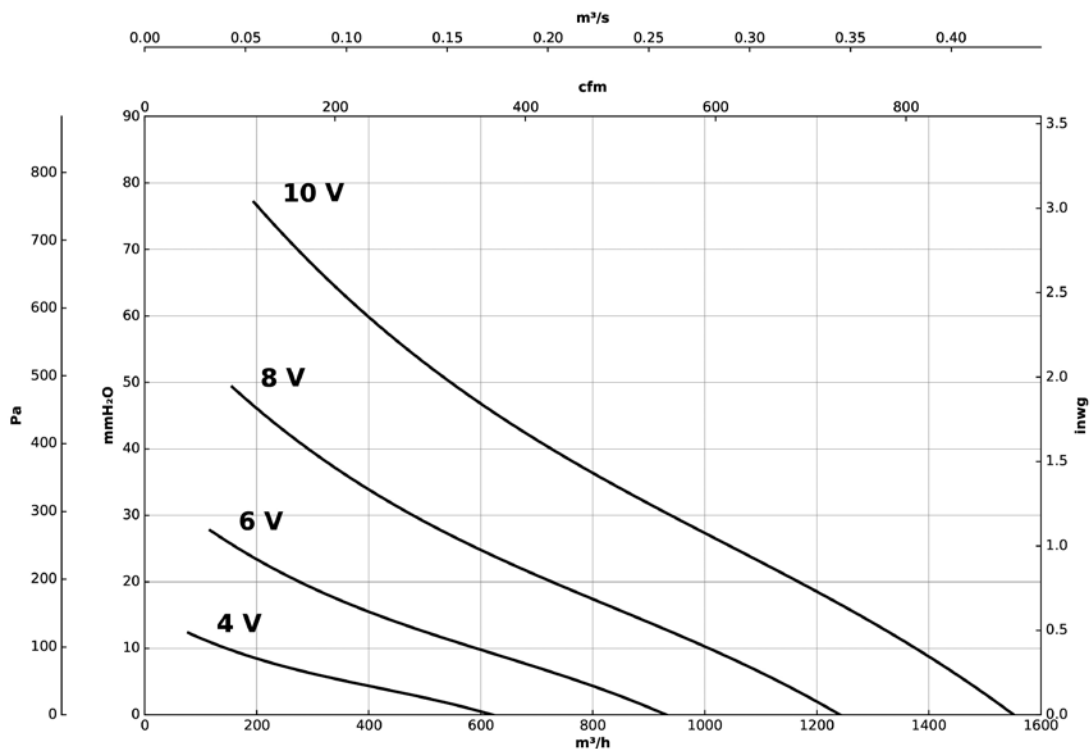

## Characteristic curves

Q= Flow rate in m<sup>3</sup>/h, m<sup>3</sup>/s and cfm

Pe= Static pressure in mm H<sub>2</sub>O, Pa and inwg

### CRF/EW-315-M/L

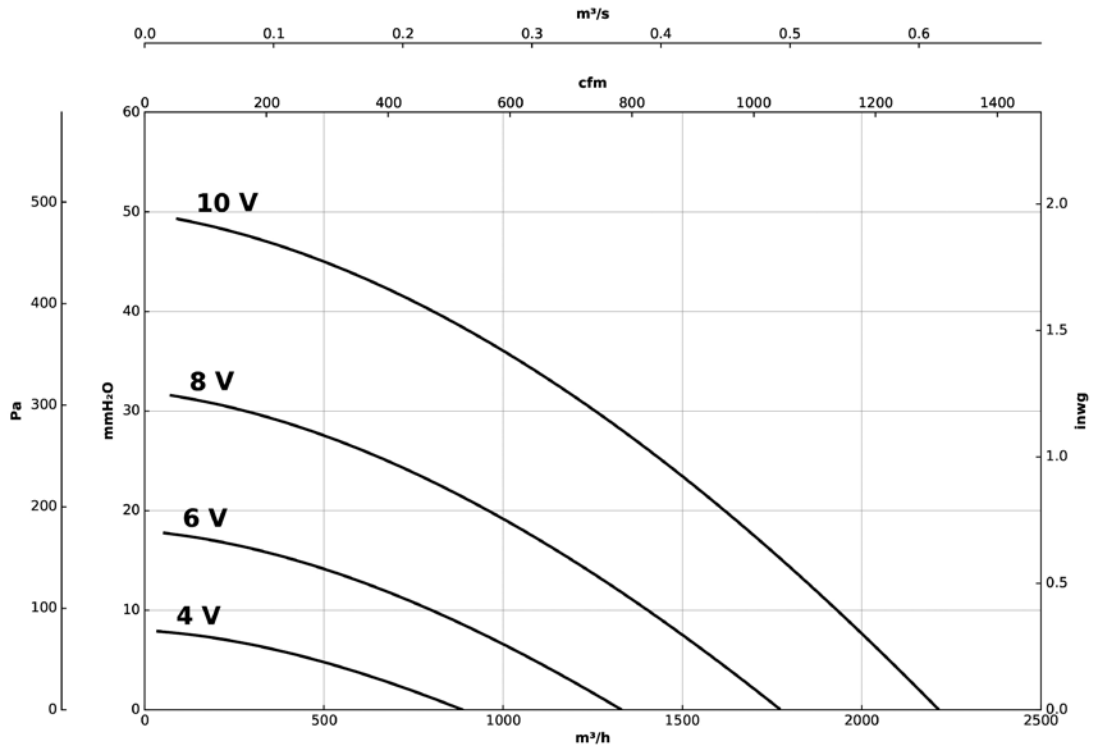

### CRF/EW-315-M/H

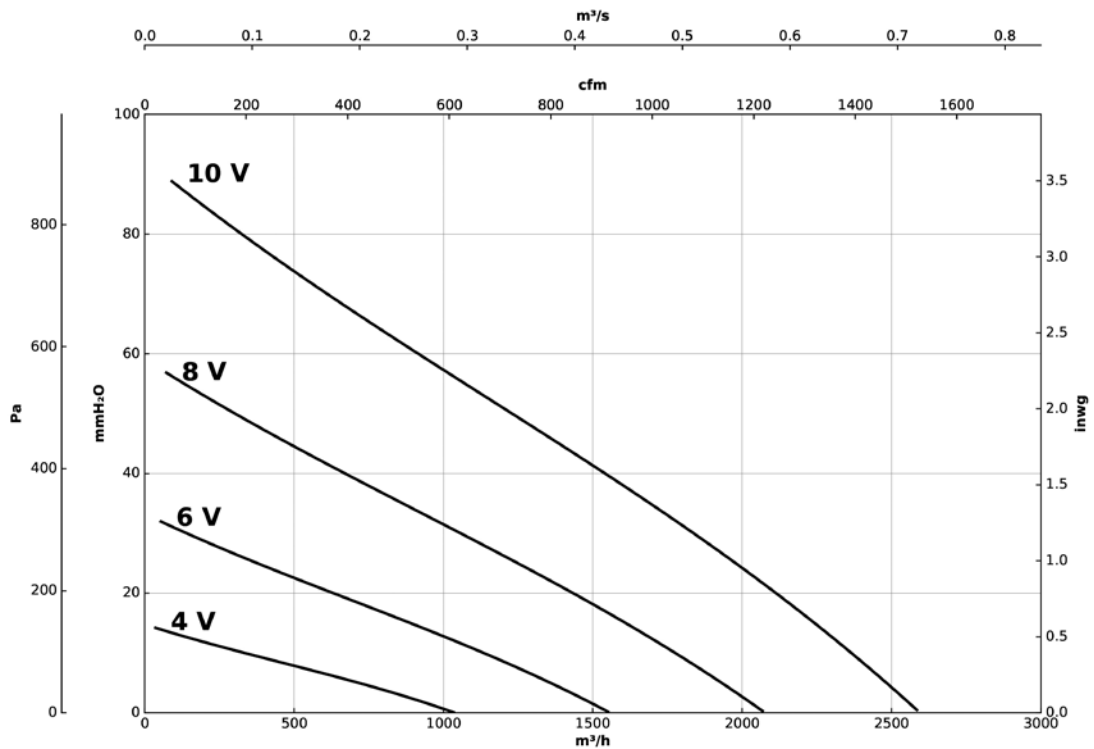

### Characteristic curves

Q= Flow rate in m<sup>3</sup>/h, m<sup>3</sup>/s and cfm

Pe= Static pressure in mm H<sub>2</sub>O, Pa and inwg

**CRF/EW-400-M/M**

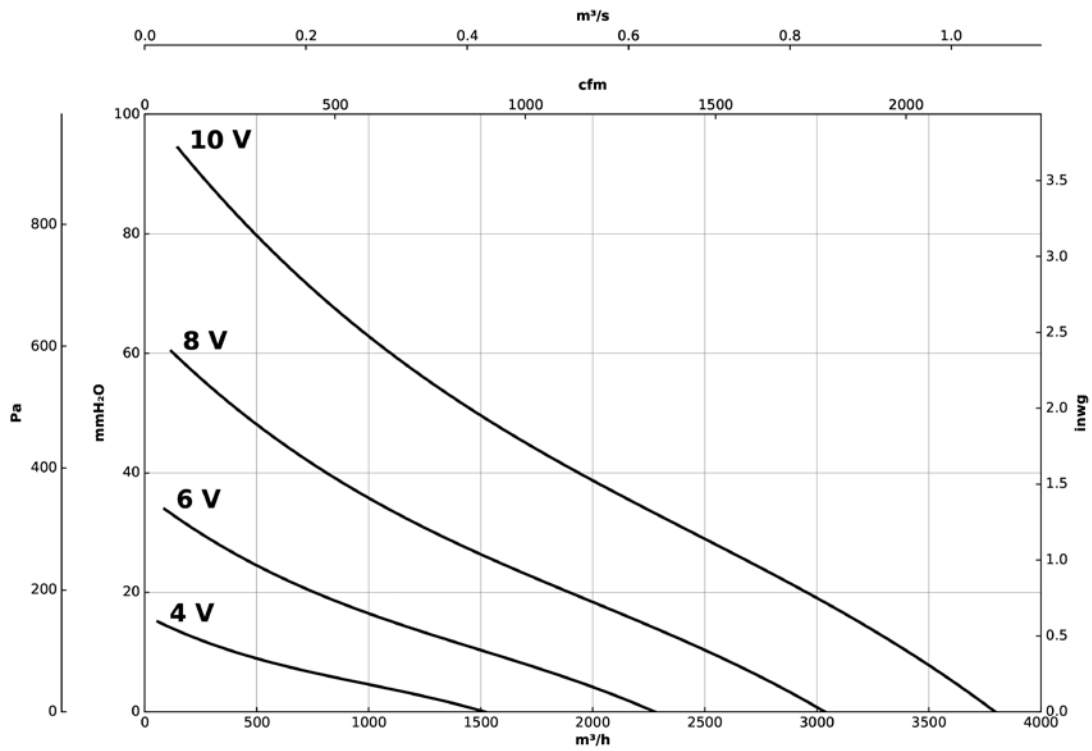

**CRF/EW-400-M/H**

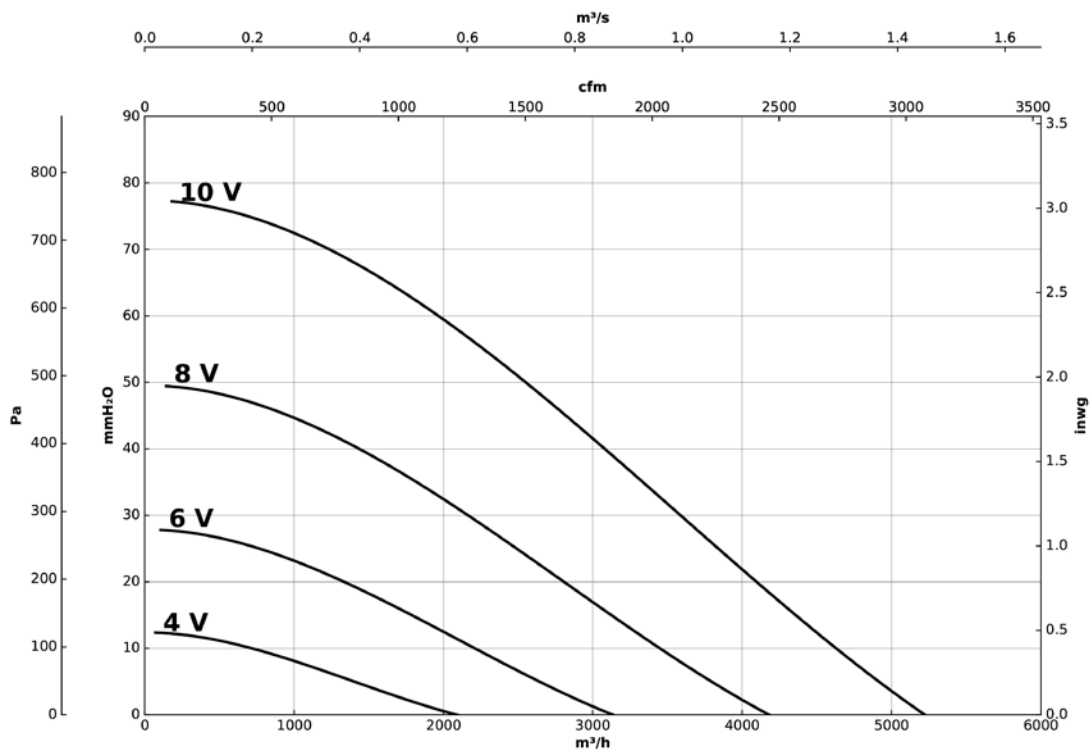

## Characteristic curves

Q= Flow rate in m<sup>3</sup>/h, m<sup>3</sup>/s and cfm

Pe= Static pressure in mm H<sub>2</sub>O, Pa and inwg

### CRF/EW-400-T

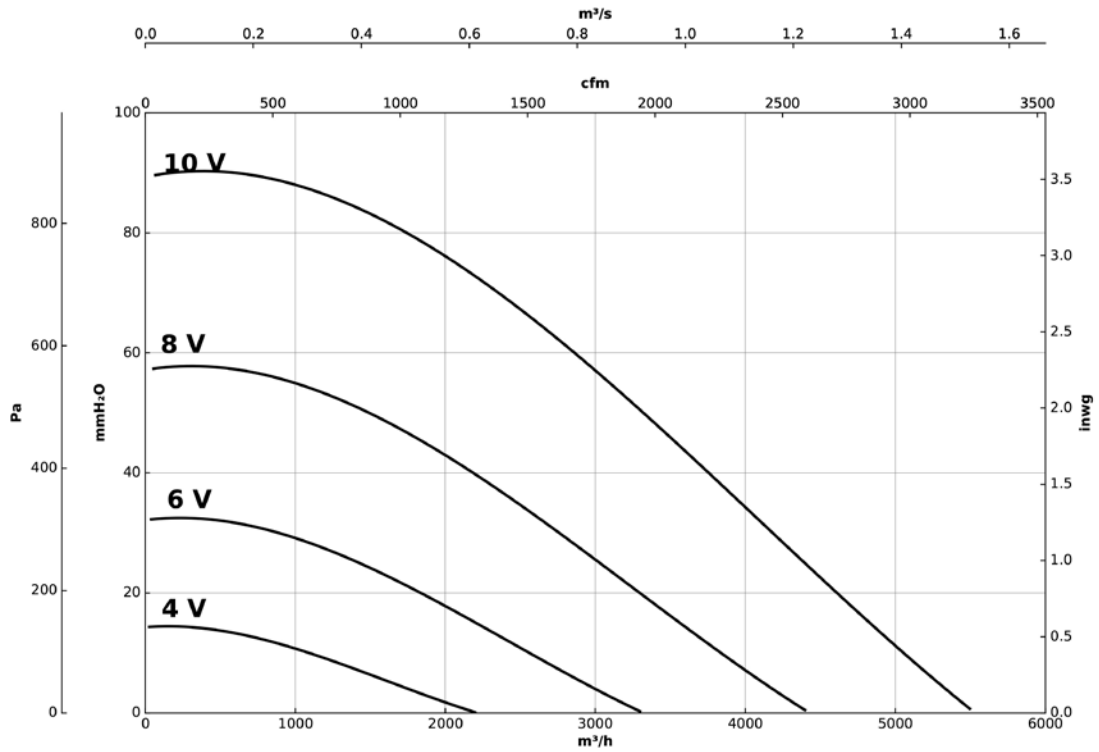

### CRF/EW-500-M

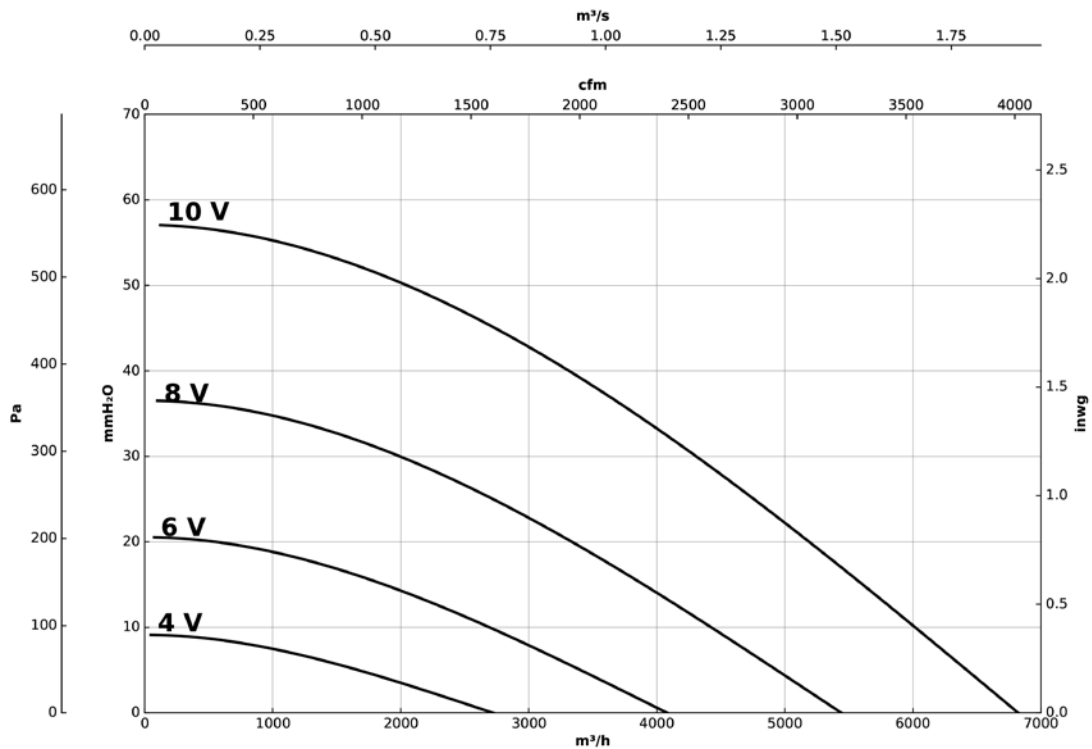

### Characteristic curves

Q= Flow rate in m<sup>3</sup>/h, m<sup>3</sup>/s and cfm

Pe= Static pressure in mm H<sub>2</sub>O, Pa and inwg

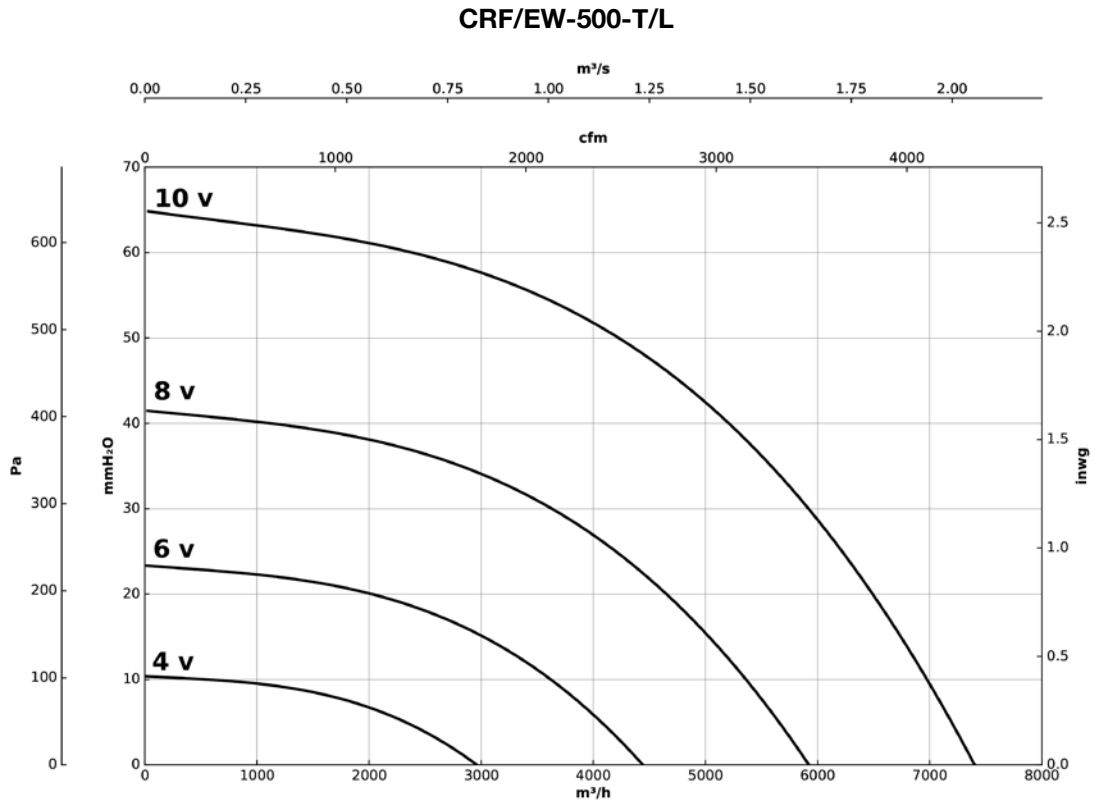

# CRF/EW/CPC



**Centrifugal roof fans, automatic operation, low noise level, EC Technology motor and constant pressure control**



Centrifugal roof mounted extract fans with low noise levels and external rotor motor, fitted with an EC Technology motor.

**Fan:**

- Galvanized steel sheet construction.
- Backward curved impeller made of plastic material.
- Bird protection grid.
- Folding body for ease of inspection and maintenance.

**Motor:**

- High efficiency EC Technology motors, outer rotor adjustable via 0-10 V signal. IP54 protection.
- Single-phase 230 V 50/60 Hz and three-phase 400 V 50/60 Hz.
- Maximum temperature of air to be carried: -25 °C +50 °C.

EC CONTROL: Supplied as an optional accessory. Control panel for ventilation systems with EC Technology motors with the electronics integrated in the motor itself. With the following characteristics:

- CPC: Constant pressure control.
- CFC: Constant flow control.
- DAY/NIGHT: Double pressure setpoint adjustment according to time of day.
- External sensor: compatible with temperature, humidity, air quality or CO sensor.
- Equipment preconfigured in constant pressure mode with 100 Pa set point.

**Finish:**

- Anti-corrosive in galvanized steel sheet.

**Order code**

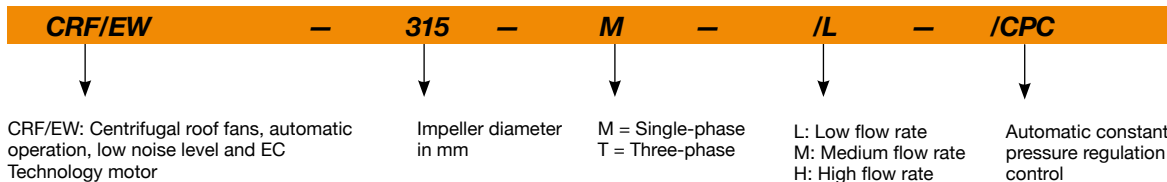

**Technical characteristics**

Model	Max. speed (r/min)	Maximum admissible current (A)		Max. electric power (kW)	Maximum flow rate (m³/h)	NPS at maximum speed dB (A)*		Approx. weight (Kg)	According ErP
		230V	400V			Inlet	Exhaust		
CRF/EW-190-M/CPC	3570	1.01		0.127	718	42	45	10	2018
CRF/EW-250-M/CPC	2850	1.35		0.180	1553	44	47	12	2018
CRF/EW-315-M/L/CPC	1920	1.35		0.175	2223	35	38	16	2018
CRF/EW-315-M/H/CPC	2377	2.00		0.450	2597	49	52	18	2018
CRF/EW-400-M/M/CPC	1550	2.00		0.460	3811	45	48	27	2018
CRF/EW-400-M/H/CPC	1700	4.70		0.750	5202	49	52	28	2018
CRF/EW-400-T/CPC	2000		1.68	0.950	5573	51	58	29	2018
CRF/EW-500-M/CPC	1200	4.80		0.720	6831	43	49	48	2018
CRF/EW-500-T/L/CPC	1250		2.00	1.150	7401	48	54	50	2018

\* The noise level values are pressures in dB(A) measured at a distance of 6 metres and at 2/3 of the maximum flow rate (2/3 Qmax).



## Erp. (Energy Related Products)

Information on Directive 2009/125/EC can be downloaded from the SODECA website or the QuickFan selector programme.

## Acoustic characteristics

Sound power spectrum Lw(A) in dB(A) per Hz frequency band

Values measured at inlet with 2/3 maximum flow rate (2/3 Qmax).

	63	125	250	500	1000	2000	4000	8000
190-M	28	45	51	58	60	61	57	52
250-M	34	49	55	60	62	61	59	50
315-M/L	29	51	48	53	53	51	47	40
315-M/H	46	61	63	66	65	66	61	55
400-M/M	46	60	57	63	61	59	54	57
400-M/H	39	63	62	68	65	63	58	60
400-T	40	53	65	71	68	68	63	63
500-M	41	55	56	60	62	61	57	50
500-T/L	45	57	60	65	65	65	62	56

Values measured at exhaust with 2/3 maximum flow rate (2/3 Qmax).

	63	125	250	500	1000	2000	4000	8000
190-M	31	48	54	61	63	64	60	55
250-M	37	52	58	63	65	64	62	53
315-M/L	32	54	51	56	56	54	50	43
315-M/H	49	64	66	69	68	69	64	58
400-M/M	49	63	60	66	64	62	57	60
400-M/H	42	66	65	71	68	66	61	63
400-T	45	56	68	73	78	76	70	66
500-M	43	56	59	67	69	65	59	53
500-T/L	46	59	63	71	75	69	65	59

## Dimensions mm

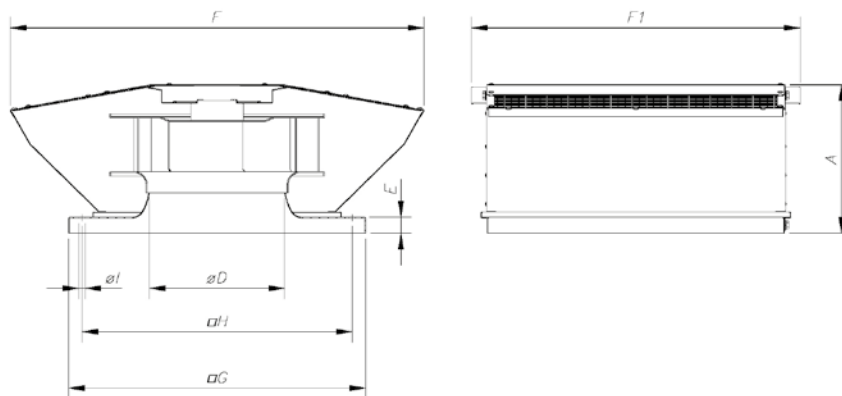

	A	ØD*	E	F	F1	G	H	øl
CRF/EW/CPC-190	185	124	30	477	420	355	305	12
CRF/EW/CPC-250	190	165	30	518	465	400	350	12
CRF/EW/CPC-315	277	204	30	701	515	450	400	12
CRF/EW/CPC-400	365	257	30	850	622	560	510	12
CRF/EW/CPC-500	426	321	30	1137	775	710	660	12

\* Recommended nominal tube diameter

## Accessories



INT



RM



PA



MS



PT



SI-CO2 IND



SI-TEMP IND



SI-TEMP+HUMEDAD



SI-HUMEDAD



SI-MF



SI-PRESIÓN

## Characteristic curves

Q= Flow rate in m<sup>3</sup>/h, m<sup>3</sup>/s and cfm

Pe= Static pressure in mm H<sub>2</sub>O, Pa and inwg

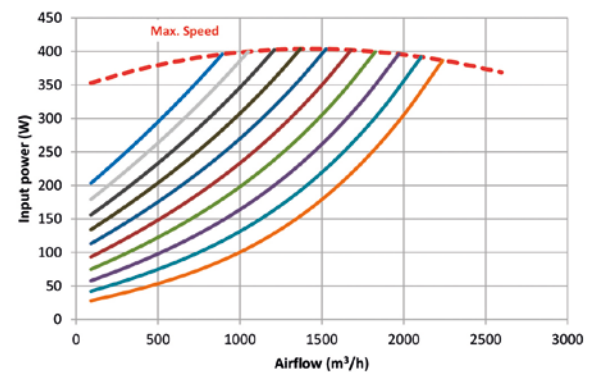
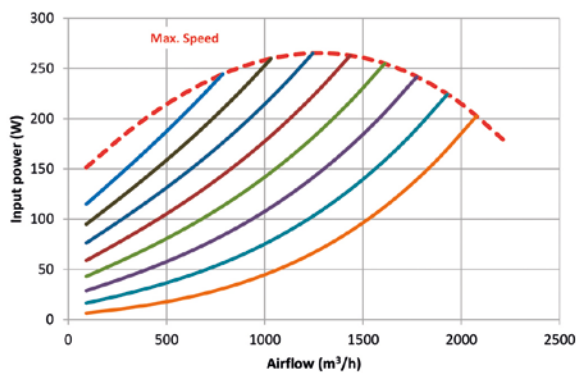
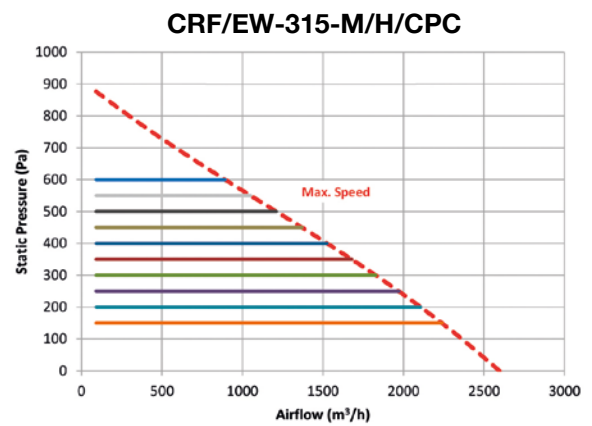
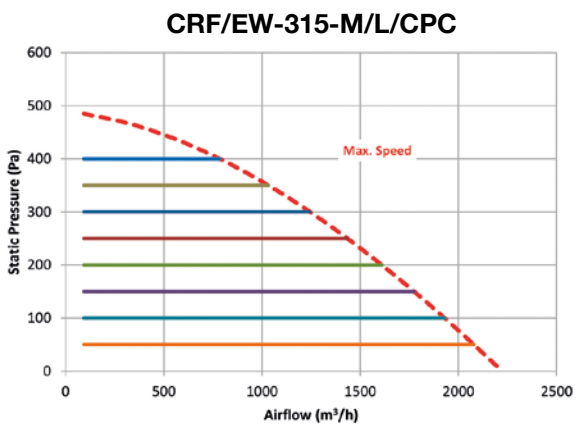
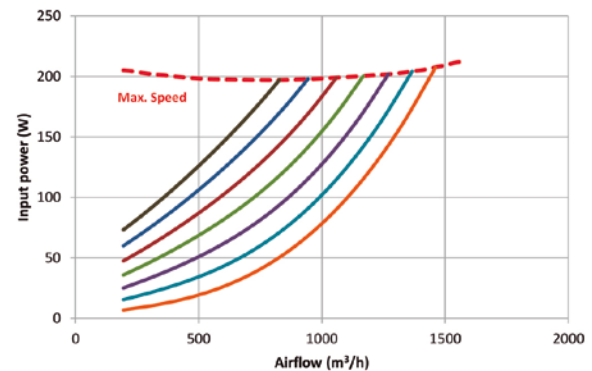
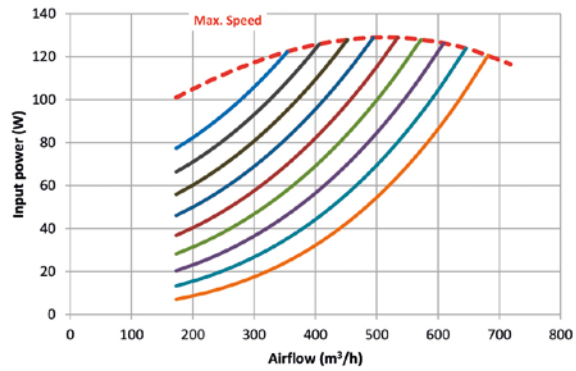
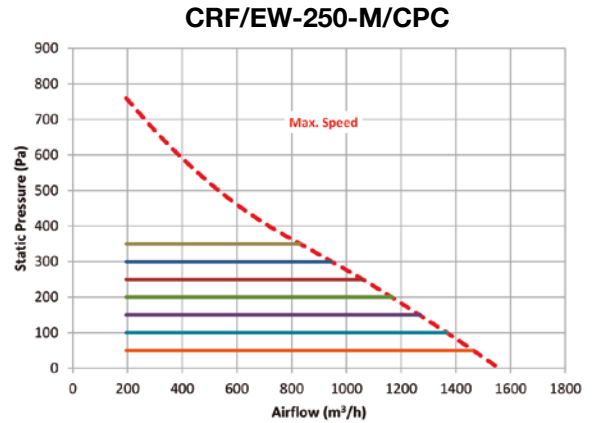
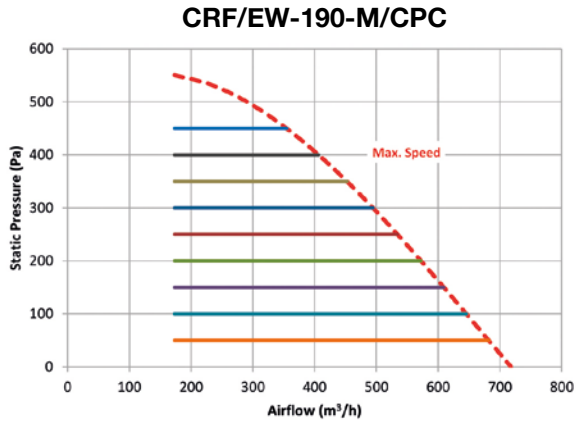



## Characteristic curves

Q= Flow rate in m<sup>3</sup>/h, m<sup>3</sup>/s and cfm

Pe= Static pressure in mm H<sub>2</sub>O, Pa and inwg

### CRF/EW-400-M/M/CPC

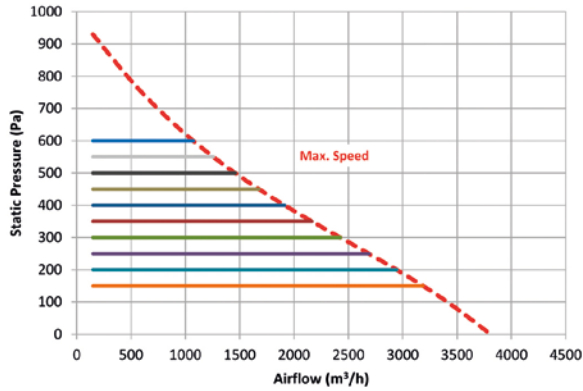

### CRF/EW-400-M/H/CPC

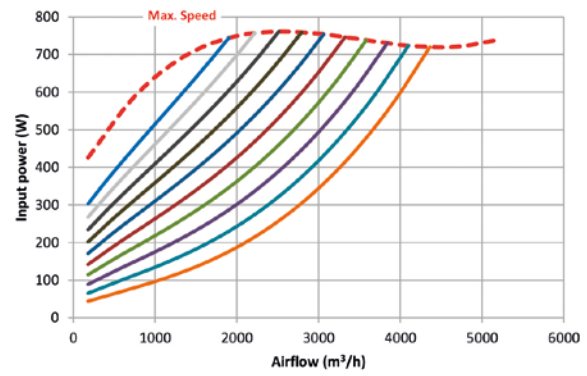
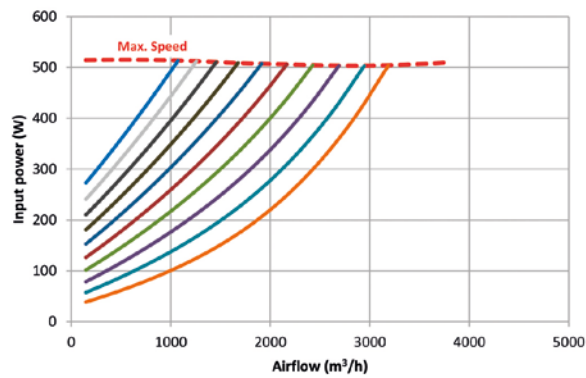
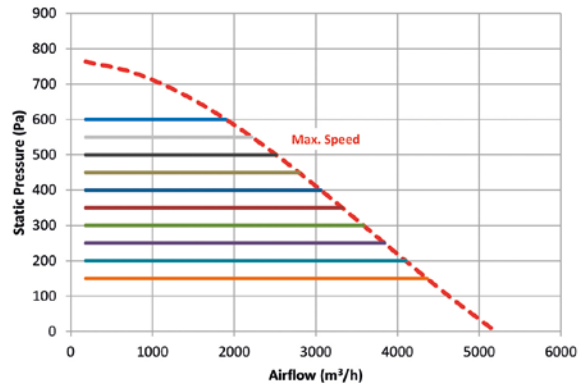

### CRF/EW-400-T/CPC

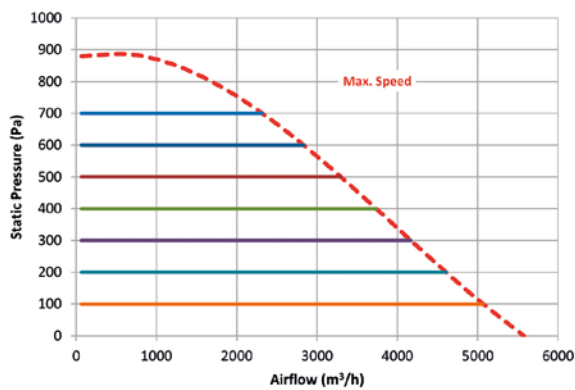

### CRF/EW-500-M/CPC

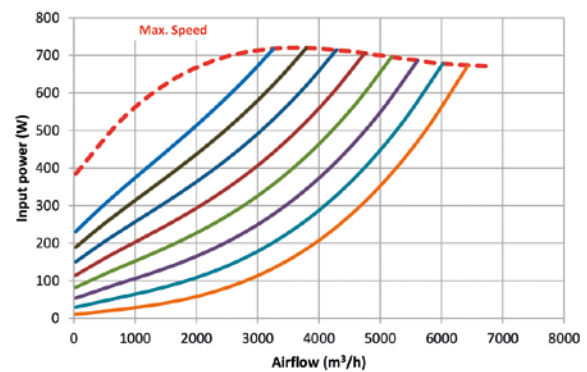
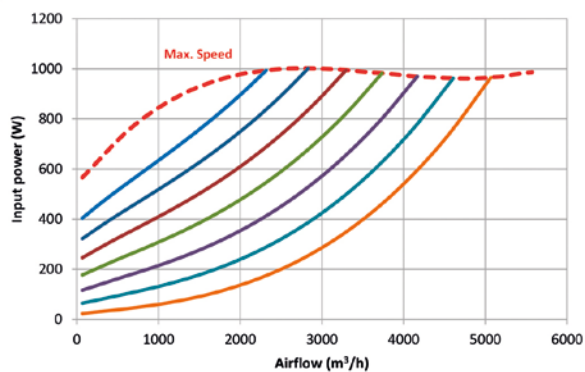
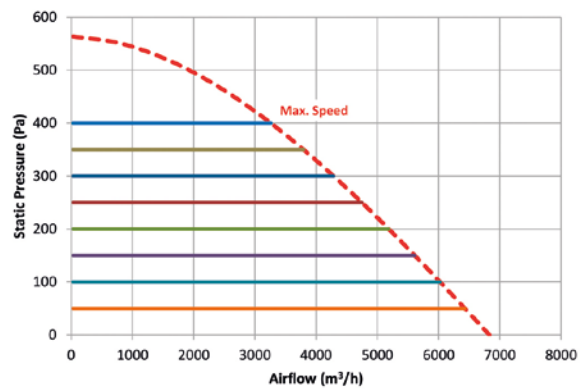

## Characteristic curves

Q= Flow rate in m<sup>3</sup>/h, m<sup>3</sup>/s and cfm

Pe= Static pressure in mm H<sub>2</sub>O, Pa and inwg

CRF/EW-500-T-L/CPC

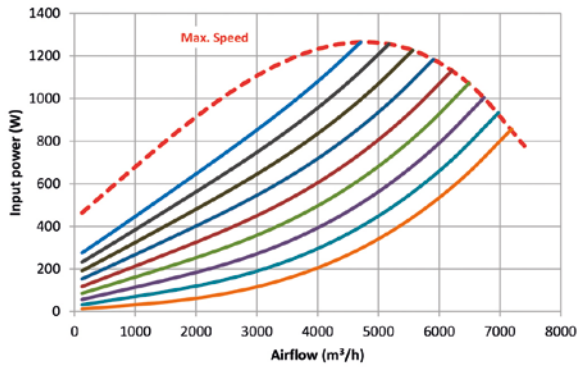
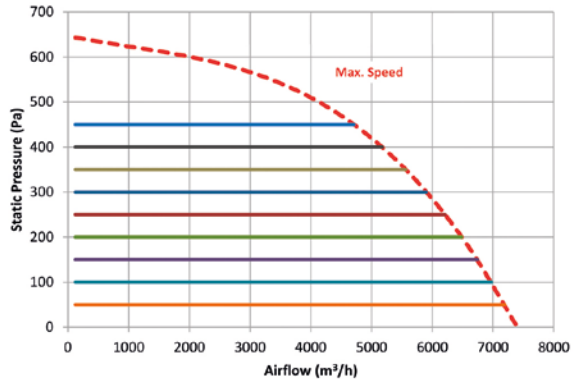

# HRE/EC

Circular axial fans with EC Technology outer rotor motor



Circular axial fans with EC Technology outer rotor motor, specially designed for high energy efficiency

**Fan:**

- Support ring in sheet steel.
- Protection grid against contacts according to UNE-EN ISO 12499.
- Plastic impeller (25) and sheet steel impeller (sizes 30 and 35).
- Grille impeller airflow direction.

**Motor:**

- High efficiency EC Technology motors, outer rotor adjustable via 0-10 V signal. IP44 protection.
- Single-phase 230 V 50/60 Hz and three-phase 400 V 50/60 Hz.
- Working temperature: -25 °C +60 °C.

**Finish:**

- Anti-corrosive finish in polyester resin, polymerised at 190 °C, after degreasing with phosphate-free nanotechnology treatment.

## Order code

**HRE/EC – 30 – M**

HRE/EC: Circular axial fans with EC Technology outer rotor motor

Impeller diameter in mm

M = Single-phase  
T = Three-phase

## Technical characteristics

Model	Max. speed	Maximum admissible current (A)	Max. electric power	Maximum flow rate	Sound pressure level	Approx. weight	According ErP
	(r/min)	230V	(W)	(m <sup>3</sup> /h)	dB (A)	(Kg)	
HRE/EC-25-M	2915	1.63	228	1540	68	3	2015
HRE/EC-30-M	2263	1.15	159	2590	66	3	2015
HRE/EC-35-M	1838	1.29	173	3340	63	5	2015



## Erp. (Energy Related Products)

Information on Directive 2009/125/EC can be downloaded from the SODECA website or the QuickFan selector programme.

## Accessories

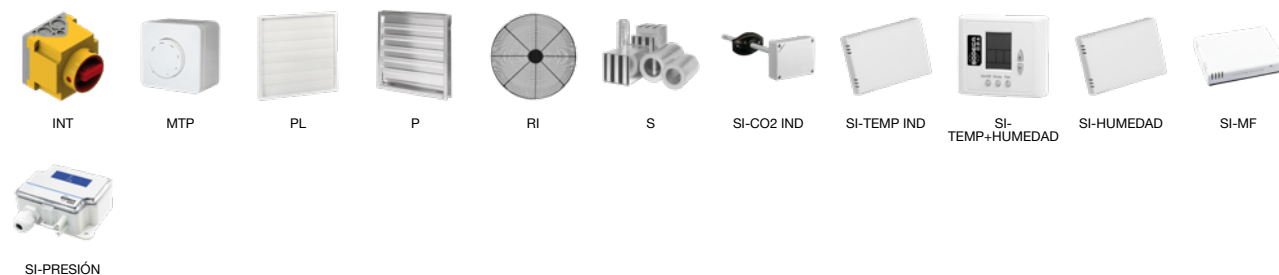

## Dimensions mm

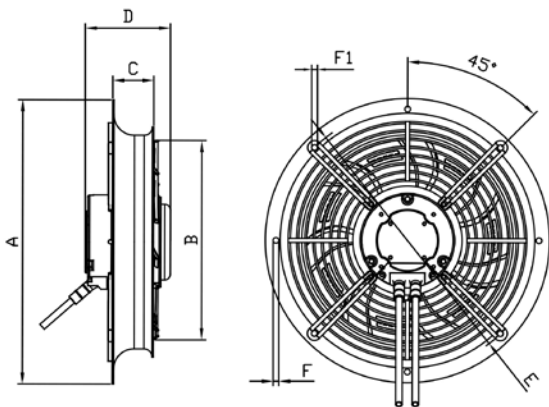

	ØA	ØB	C	D	ØE	ØF1	ØF
HRE/EC-25-M	346	280	50	103.6	320	7	7
HRE/EC-30-M	395	338	63	103.6	360	7	10
HRE/EC-35-M	460	383	65	128.9	420	7	10

## Characteristic curves

Q= Flow rate in m<sup>3</sup>/h, m<sup>3</sup>/s and cfm

Pe= Static pressure in mm H<sub>2</sub>O, Pa and inwg

### HRE/EC-25-M

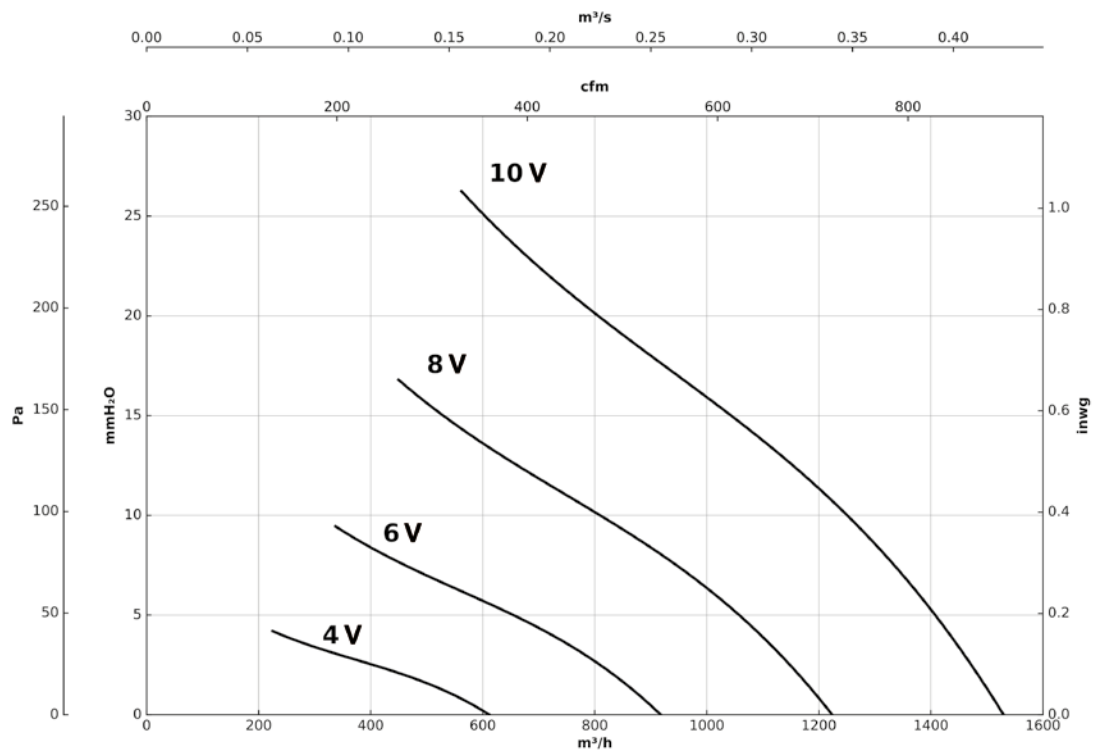

### Characteristic curves

Q= Flow rate in m<sup>3</sup>/h, m<sup>3</sup>/s and cfm

Pe= Static pressure in mm H<sub>2</sub>O, Pa and inwg

#### HRE/EC-30-M

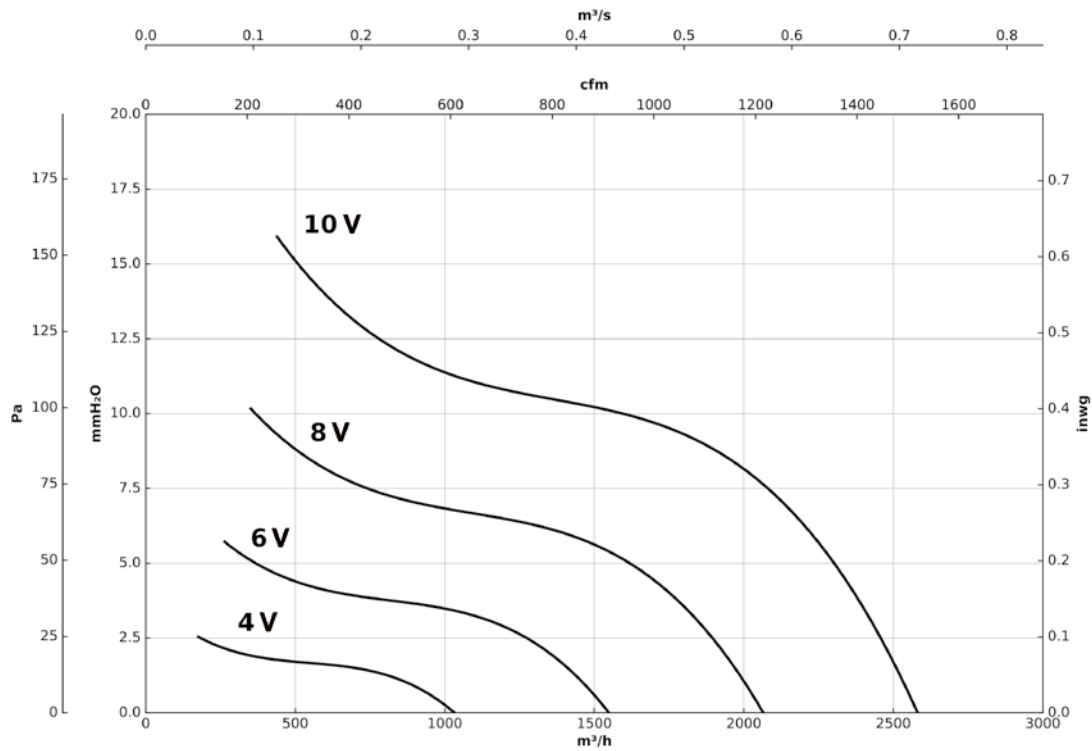

#### HRE/EC-35-M

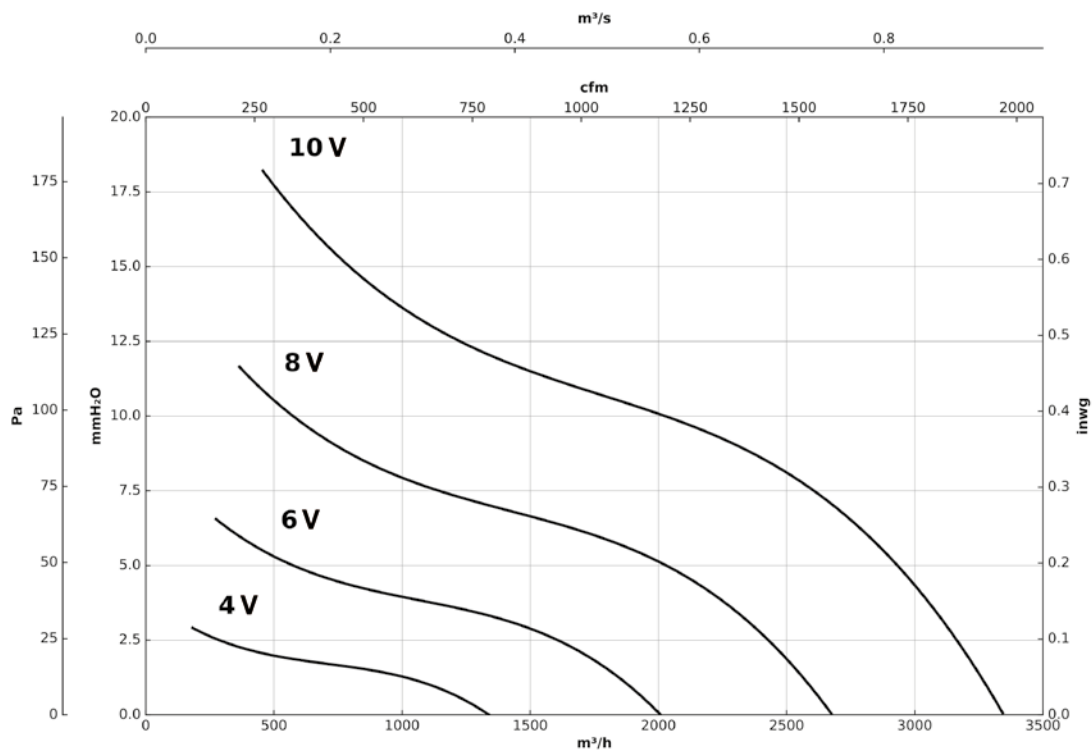

# HCRE/EC

Wall mounted axial fans with EC Technology external rotor motor



Wall mounted axial fans with EC Technology external rotor motor, specially designed to obtain high energy efficiency.

#### Fan:

- Steel sheet support frame.
- Protection grid against contacts according to UNE-EN ISO 12499.
- Plastic impeller (sizes 40 and 45) and sheet steel impeller (sizes 50 and 63).
- Grille impeller airflow direction.

#### Motor:

- High efficiency EC Technology motors, outer rotor adjustable via 0-10 V signal. IP44 protection.
- Single-phase 230 V 50/60 Hz and three-phase 400 V 50/60 Hz.
- Working temperature: -25 °C +60 °C.

#### Finish:

- Anti-corrosive finish in polyester resin, polymerised at 190 °C, after degreasing with phosphate-free nanotechnology treatment.

## Order code

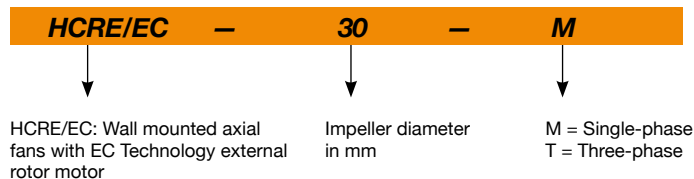

## Technical characteristics

Model	Max. speed (r/min)	Maximum admissible current (A)		Max. electric power (W)	Maximum flow rate (m³/h)	Sound pressure level dB (A)	Approx. weight (Kg)	According ErP
		230V	400V					
HCRE/EC-40-M	1914	2,20	-	480	4970	71	6	2015
HCRE/EC-45-T	2000	-	1.80	1080	8390	75	11	2015
HCRE/EC-50-T	1800	-	1.60	960	9800	78	16	2015
HCRE/EC-63-T	1250	-	1.85	1100	14220	78	24	2015



## Erp. (Energy Related Products)

Information on Directive 2009/125/EC can be downloaded from the SODECA website or the QuickFan selector programme.

## Accessories



### Dimensions mm

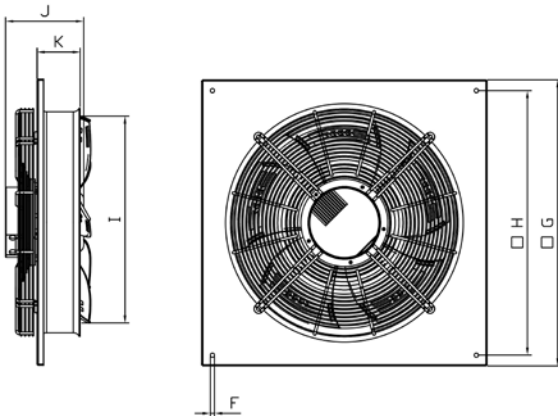

	ØF	G	H	ØI	J	K
HCRE/EC-40-M	10	540	490	430	151.4	96
HCRE/EC-45-T	10	575	520	480	182	100
HCRE/EC-50-T	10	665	615	530	182	100
HCRE/EC-63-T	12	805	750	706	192.5	135

### Characteristic curves

Q= Flow rate in m<sup>3</sup>/h, m<sup>3</sup>/s and cfm

Pe= Static pressure in mm H<sub>2</sub>O, Pa and inwg

#### HCRE/EC-40-M

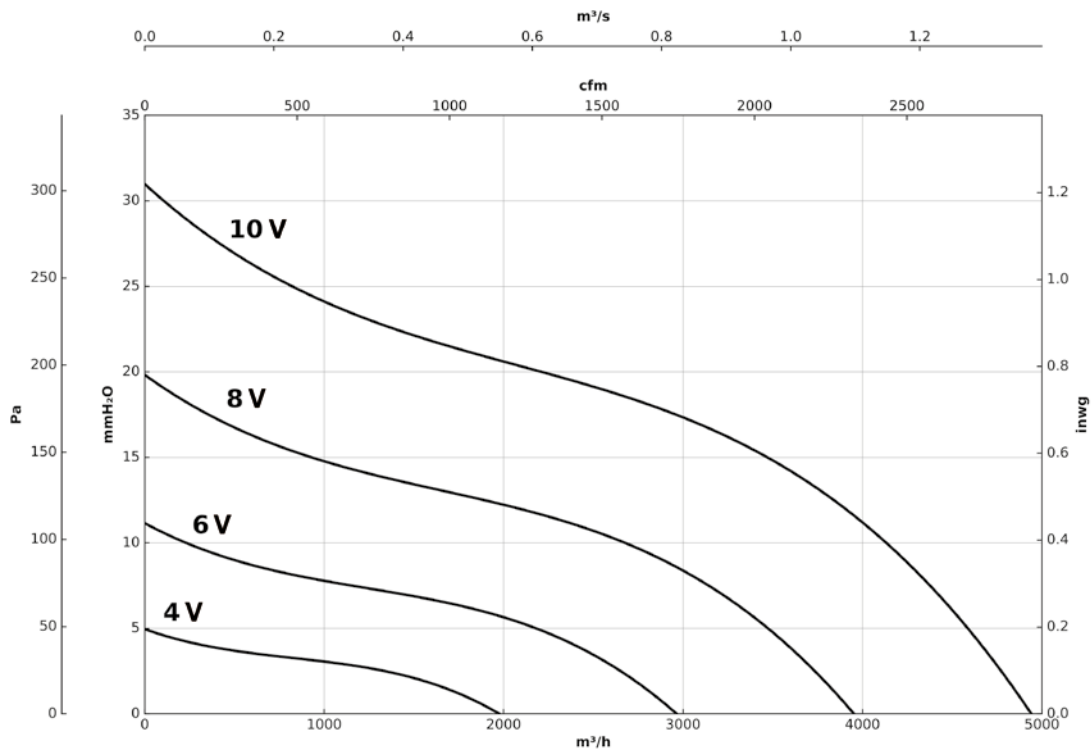

## Characteristic curves

Q= Flow rate in m<sup>3</sup>/h, m<sup>3</sup>/s and cfm

Pe= Static pressure in mm H<sub>2</sub>O, Pa and inwg

### HCRE/EC-45-T

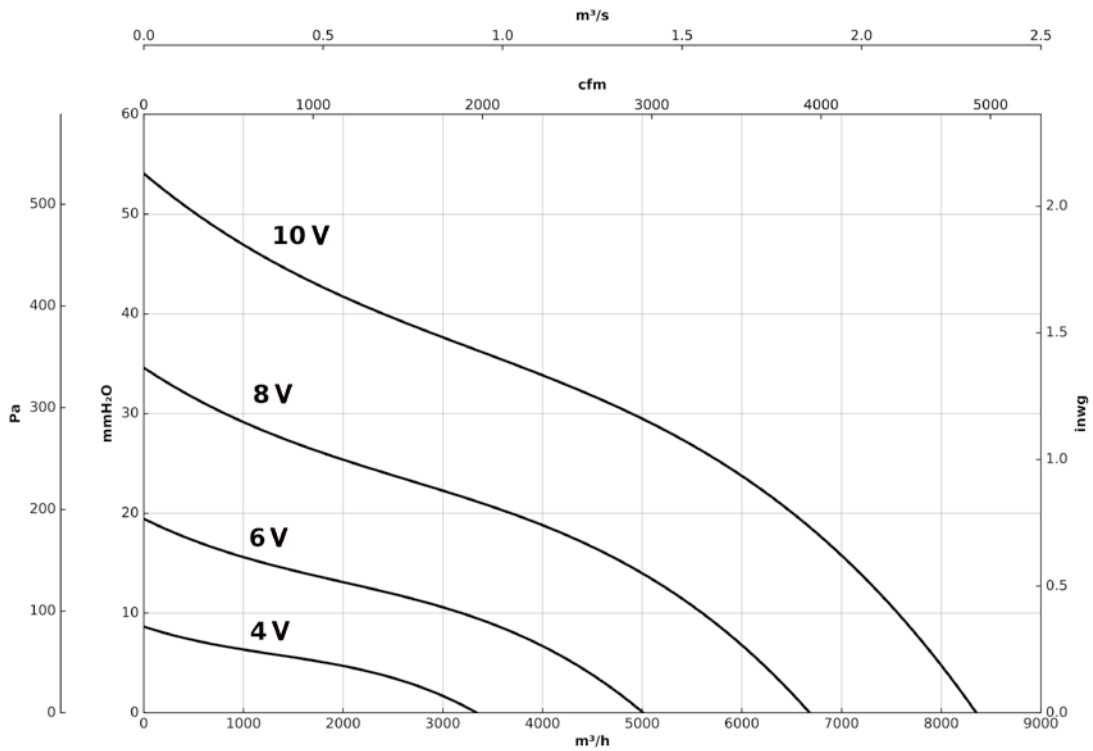

### HCRE/EC-50-T

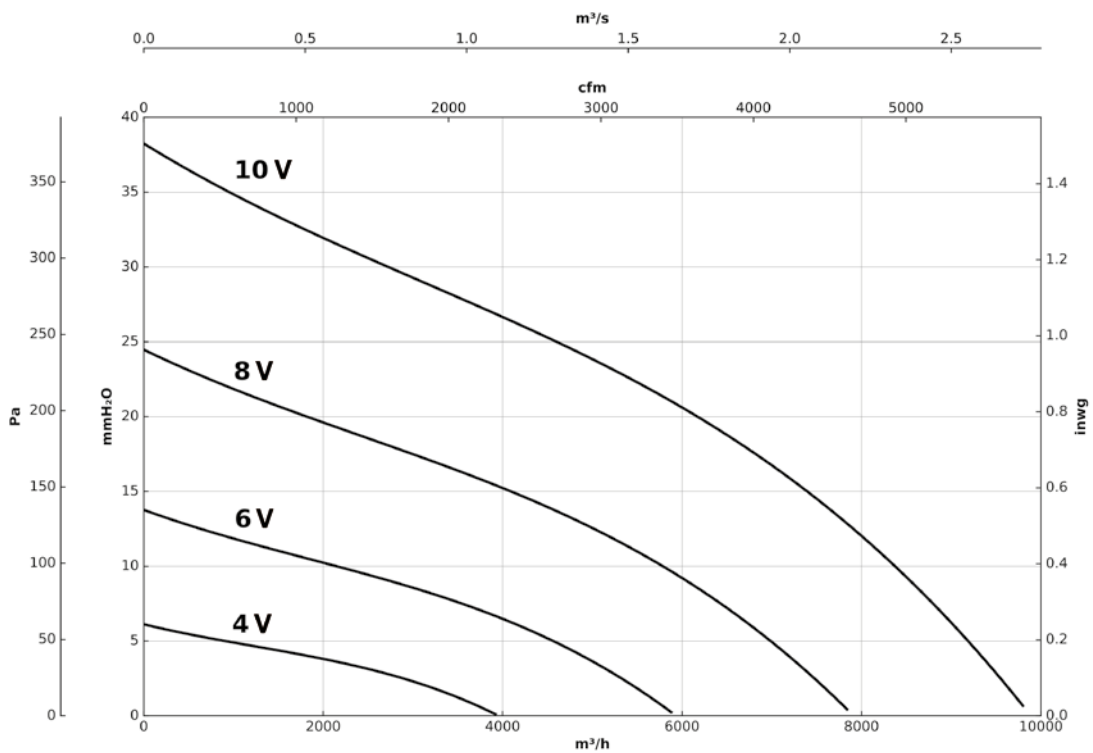



### Characteristic curves

Q= Flow rate in m<sup>3</sup>/h, m<sup>3</sup>/s and cfm

Pe= Static pressure in mm H<sub>2</sub>O, Pa and inwg

#### HCRE/EC-63-T

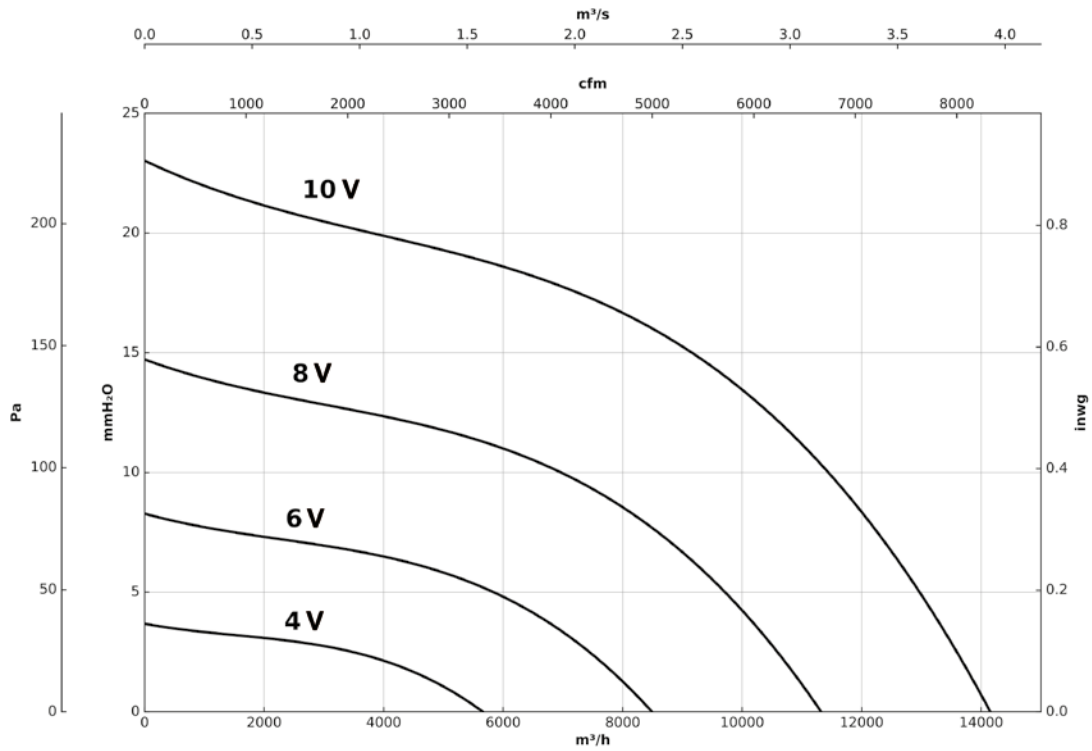

# VENUS

High efficiency single zone heat recovery ventilators for residential installations

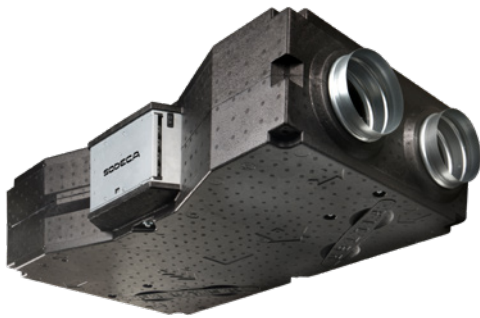

EC version control



High performance heat recovery ventilators to be installed inside residential buildings. With a low power consumption and heat recovery efficiency of up to 93%. For technical ceiling installation.

**Finishing:**

- Light expanded polypropylene body for low noise emission levels.
- Low profile models for false ceiling installation.
- 160 mm inlets/outlets (models 150 and 300) and 250 mm inlets/outlets (models 500 and 700).

**Features of all versions:**

- Counterflow heat exchanger.

- Flow adjustment capacity according to external control signal.
- Condensate drain with built-in siphon.
- Access to filters and condensate drainage from above and below.

**Additional features of the EC version:**

- Operation compatible 50/60 Hz.
- Air supply filters with F7 efficiency level.
- High efficiency EC fans.
- Digital remote control panel included.
- Antifreeze protection and free cooling.
- Multizone control through the possibility of connecting CO<sub>2</sub>, PIR (presence) and HR (relative humidity) sensors. ALL / NOTHING type signal.

Version	AC	EC
Motor Type	AC	EC (high efficiency)
Control panel	Manual selector CP-SM-V-4 (accessory not included)	Digital (included)
Control panel cable	4-wire, 230V (not included)	4-wire PTPM-RJ12 10 m Included/ Maximum 30 m
No. of fan speeds	3	3
Supply/Extraction filter efficiency	F5 / G4	F7 / G4
Alarm management	YES	YES
Flow control via external control	YES	YES
Each fan adjusted precisely	-	YES
Control of closing hatches	-	YES (hatches not supplied)
Connections to 5 optional sensors	-	Types: CO <sub>2</sub> / PIR / HR
Sensor power supply	-	15V DC
External control to force maximum flow	-	YES
Free cooling by stopping 1 fan	-	YES (with timer setting)
Antifreeze protection	-	YES
Adjustable filter change alarm	-	YES
LED filter state control	YES	YES

**Order code**

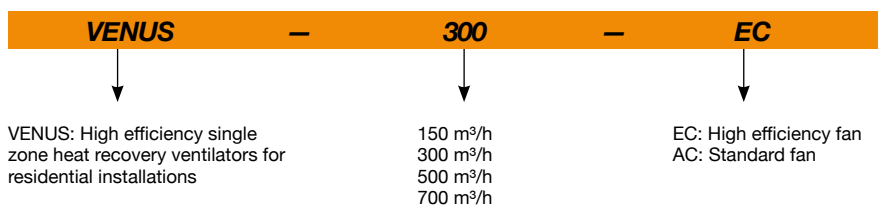

## Technical characteristics

Model	Maximum flow rate (m <sup>3</sup> /h)	Total power (W)	Recovery efficiency (%)	Maximum admissible current (A) 220-240V	Irradiated sound level at 3 m dB (A)	Approx. weight (Kg)	According ErP
VENUS-150-AC	185	105	93	2 x 0.23	37.3	17.4	2018
VENUS-150-EC	175	65	93	2 x 0.14	37.7	17.2	2018
VENUS-300-AC	265	145	93	2 x 0.32	38.9	19.5	2018
VENUS-300-EC	315	170	93	2 x 0.37	43.5	19.3	2018
VENUS-500-AC	515	230	93	2 x 0.50	47.1	35	2018
VENUS-500-EC	535	220	93	2 x 0.48	45.8	35.5	2018
VENUS-700-AC	650	270	93	2 x 0.59	42.9	40	2018
VENUS-700-EC	785	430	93	2 x 0.93	53.6	40.7	2018



### Erp. (Energy Related Products)

Information on Directive 2009/125/EC can be downloaded from the SODECA website or the QuickFan selector programme.

## Characteristic curves

Q= Flow rate in m<sup>3</sup>/h, m<sup>3</sup>/s and cfm

Pe= Static pressure in mm H<sub>2</sub>O, Pa and inwg

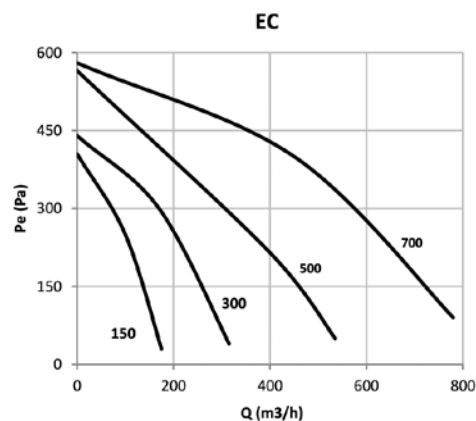
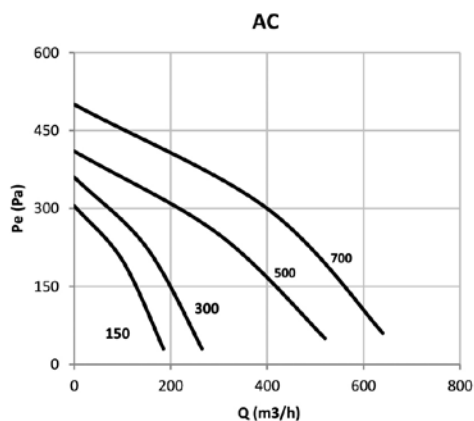

## Installation

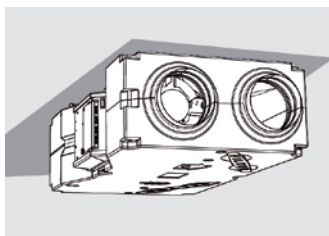

In false ceilings

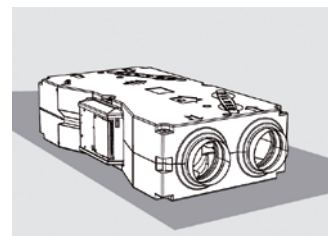

Floor-mounted

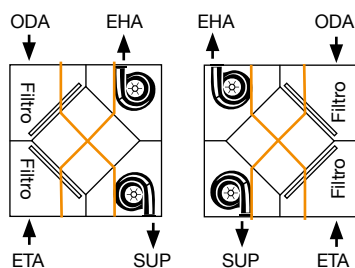

Configuration may be chosen by turning the machine through 180°. Access to filters and drainage from above and below.

ODA: Fresh outdoor air / SUP: Air impulsion to the premise / EHA: Exit of exhaust air / ETA: Air extraction from premises

## Dimensions mm

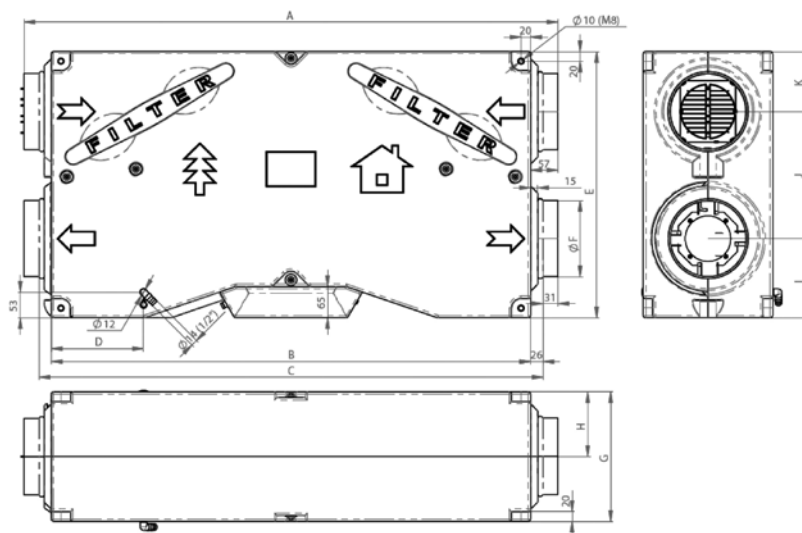

	A	B	C	D	E	ØF	G	H	I	J	K
VENUS 150 / 300	1114	1000	1051	193	555	159	270	135	165	265	125
VENUS 500 / 700	1505	1391	1441	248	846	249	360	180	235	420	190

## Accessories



CP-SM-V-4



RH SENSOR



PIR SENSOR



CO2 sensor



Compuerta de cierre



SERVO DE COMPUERTA



FILTROS



CABLE PTPM-RJ12

# REB

Heat recovery units with EC Technology motor and built-in by-pass



REB-15...120



REB-180...270



REB-400...600

Heat recovery units with EC Technology motor and built-in by-pass, low power consumption and heat recovery efficiency of over 86%.

**Characteristics:**

- Counterflow heat exchanger.
- With 100% automatic by-pass (except model REB-15).
- Low consumption fans with built-in regulation.
- Lateral maintenance access.
- Operation compatible 50/60 Hz.
- Particle filters with efficiencies depending on models.

**Finishing on models 15 to 120:**

- Equipment structure made of anti-corrosive galvanised sheet steel.
- Anti-condensation foam coating.
- Interior in lightweight expanded

polypropylene and with low noise emissions.

- Low profile models for false ceiling installation.

**Finishing on models 180 and 270:**

- Aluminium profile and prefinished sheet steel structure with 25 mm thick thermal and acoustic insulation panels.
- Low profile models for false ceiling installation.

**Finishing on REB-400 and REB-600 models:**

- Aluminium profile and prefinished sheet steel structure with 30 mm thick thermal and acoustic insulation panels.
- For installation in technical rooms.
- Control compatible with MODBUS RTU.

## Order code

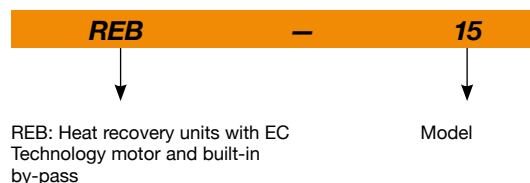

## Characteristics based on size

	REB-15	REB-25..120	REB-180..270	REB-400..600
Supply standard filters	G4	G4	G4+F9	F6+F8
Extraction standard filters	G4	G4	G4	F6
Second filter stage integrated in the fresh air circuit	-	-	YES	YES
Free cooling function 100% of flow	-	-	YES	YES
Heat recovery type	Enthalpy	Enthalpy	Enthalpy	Sensitive
Condensate exhaust	-	-	-	YES
Built-in pressure switches for filter condition control	-	-	YES	-
Maintenance switch	-	-	YES	YES
Compatible with SI-VOC+HUMEDAD control	YES	YES	YES	-
Control by MODBUS RTU	-	-	-	YES

## Technical characteristics

Model	Maximum flow rate	Total power	Maximum admissible current (A)		Recovery efficiency	Irradiated sound level at 5 m	Approx. weight	According ErP
	(m <sup>3</sup> /h)		(W)	220-240V II				
REB-15	180	60	0.26		72	38	18	Excluded
REB-25	300	70	0.30		81	35	31	2018
REB-40	480	90	0.39		82	37	39	2018
REB-60	720	140	0.61		80	39	55	2018
REB-80	960	300	1.30		82	41	72	2018
REB-120	1440	325	1.41		79	42	91	2018
REB-180	1770	750	5.80		73	53	150	2018
REB-270	2570	1000	7.20		73	53	180	2018
REB-400	4440	4800		8.00	88	61	375	2018
REB-600	6000	7800		12.40	88	61	465	2018



### Erp. (Energy Related Products)

Information on Directive 2009/125/EC can be downloaded from the SODECA website or the QuickFan selector programme.

### Accessories



## Characteristic curves

Q= Flow rate in m<sup>3</sup>/h, m<sup>3</sup>/s and cfm

Pe= Static pressure in mm H<sub>2</sub>O, Pa and inwg

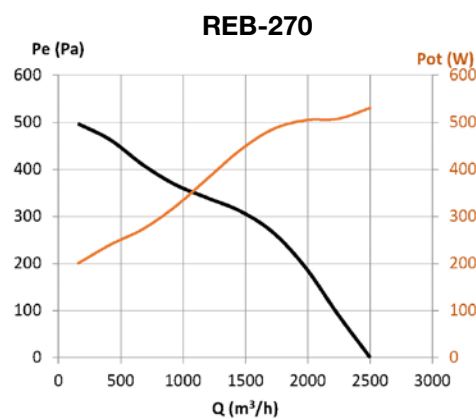
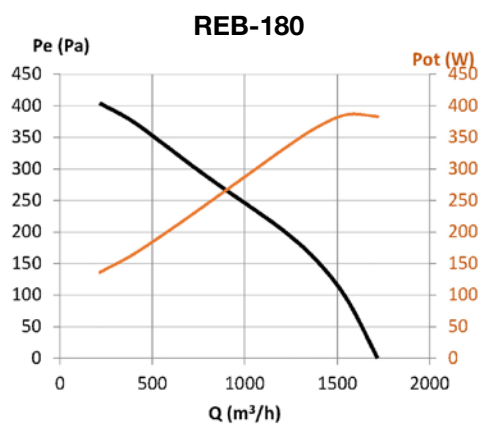
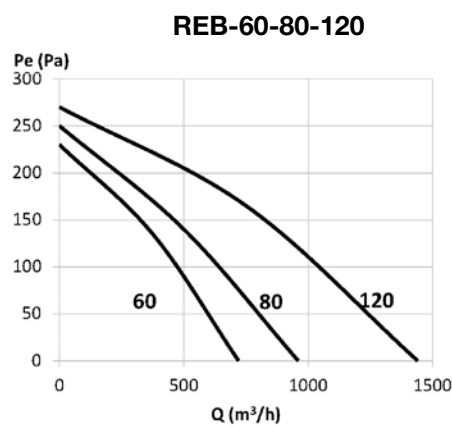
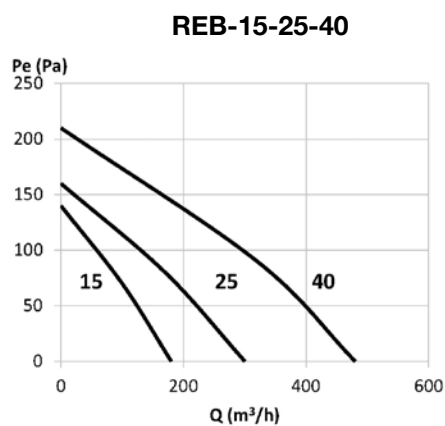

### Characteristic curves

Q= Flow rate in m<sup>3</sup>/h, m<sup>3</sup>/s and cfm

Pe= Static pressure in mm H<sub>2</sub>O, Pa and inwg

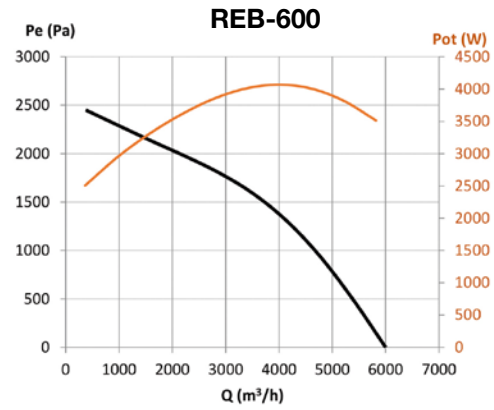
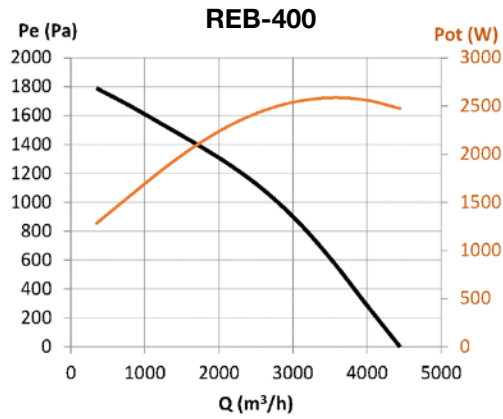

### Dimensions mm

REB-15...120

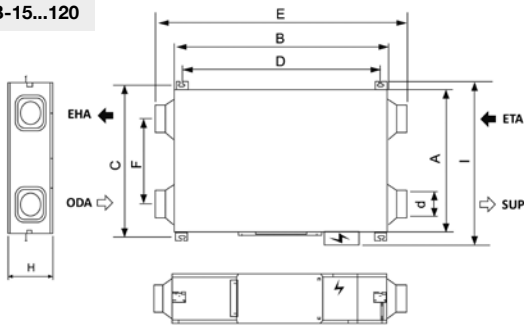

REB-180...270

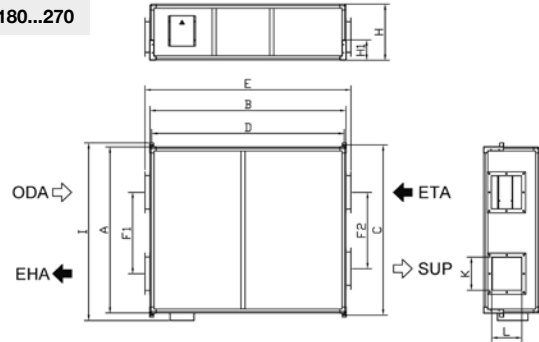

REB-400...600

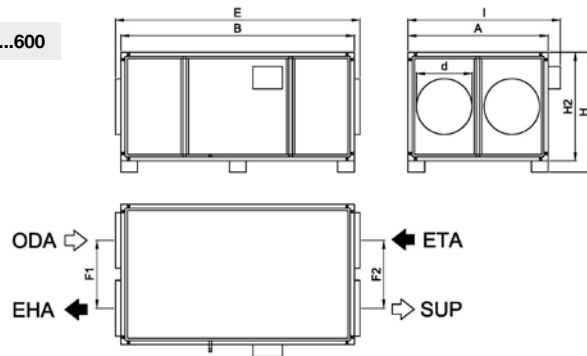

	A	B	C	D	E	F	F1	F2	H	H1	H2	I	d	K	L
REB-15	510	883	560	813	1043	345	-	-	272	-	-	620	97	-	-
REB-25	675	890	735	820	1070	335	-	-	280	-	-	790	146	-	-
REB-40	813	888	863	818	1068	480	-	-	280	-	-	930	146	-	-
REB-60	995	970	1055	910	1130	728	-	-	313	-	-	1065	197	-	-
REB-80	883	1325	953	1255	1485	429	-	-	390	-	-	1000	247	-	-
REB-120	1132	1328	1202	1258	1488	680	-	-	395	-	-	1250	247	-	-
REB-180	1240	1630	1280	1596	1730	-	554	554	558	200	-	1355	-	230	260
REB-270	1654	1950	1695	1916	2050	-	810	760	558	200	-	1769	-	330	300
REB-400	1260	1900	-	-	2000	-	600	600	818	-	718	1372	450	-	-
REB-600	1260	2100	-	-	2200	-	600	600	1075	-	975	1372	500	-	-

ODA: Fresh outdoor air / SUP: Air impulsion to the premise / EHA: Exit of exhaust air / ETA: Air extraction from premises

# REB-HEPA



Heat recovery units with EC Technology motor, built-in by-pass and HEPA filter



Heat recovery units with EC Technology motor, built-in by-pass and HEPA filter. Low power consumption and heat recovery efficiency of up to 82%.

**Characteristics:**

- Counterflow heat exchanger.
- With 100% automatic by-pass.
- Low consumption fans with built-in regulation.
- Lateral maintenance access.
- Operation compatible 50/60 Hz.

- HEPA H13 type filters with a filtration efficiency of 99.95%.

**Finish:**

- Galvanised sheet steel structure.
- Anti-condensation foam coating.
- Interior in lightweight expanded polypropylene and with low noise emissions.
- Low profile models for false ceiling installation.

## Order code

**REB-HEPA — 40**

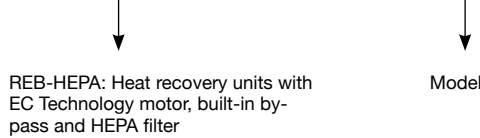

## Characteristics

Motor Type	EC
Fan speeds	3
Supply standard filters	HEPA H13
Extraction standard filters	G4
Side access to filters	YES
Free cooling function by means of a motorised by-pass	YES
Heat recovery type	Enthalpy
Compatible with SI-VOC+HUMEDAD control	YES

## Technical characteristics

Model	Maximum flow rate (m <sup>3</sup> /h)	Total power (W)	Maximum admissible current (A)	Recovery efficiency (%)	Irradiated sound level at 5 m dB (A)	Approx. weight (Kg)	According ErP
REB-HEPA-40	400	115	0.7	82	38	39	Excluded
REB-HEPA-60	600	150	0.9	80	40	55	2018
REB-HEPA-80	800	320	1.5	82	42	72	2018
REB-HEPA-120	1100	360	1.8	79	43	91	2018



### Erp. (Energy Related Products)

Information on Directive 2009/125/EC can be downloaded from the SODECA website or the QuickFan selector programme.

### Accessories

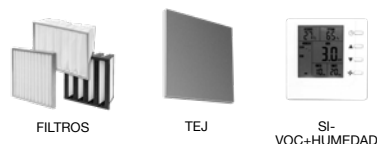



## Dimensions mm

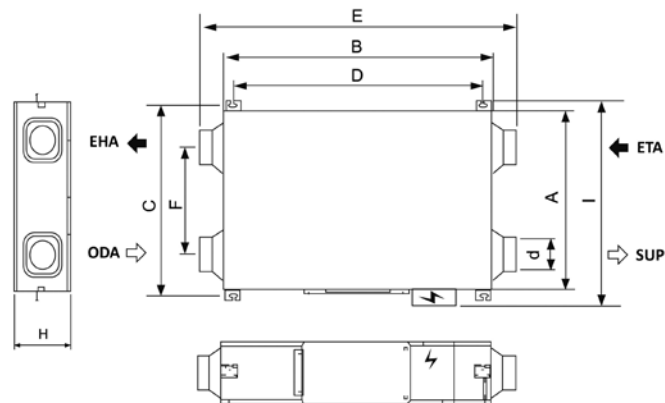

	A	B	C	D	E	F	H	I	d
REB-HEPA-40	807	984	864	913	1176	482	273	903	143
REB-HEPA-60	1007	1066	1055	1008	1230	728	322	1135	195
REB-HEPA-80	882	1402	940	1335	1565	431	400	1010	245
REB-HEPA-120	1132	1402	1190	1335	1565	681	400	1260	245

ODA: Fresh outdoor air / SUP: Air impulsion to the premise / EHA: Exit of exhaust air / ETA: Air extraction from premises

## Characteristic curves

Q= Flow rate in m<sup>3</sup>/h, m<sup>3</sup>/s and cfm

Pe= Static pressure in mm H<sub>2</sub>O, Pa and inwg

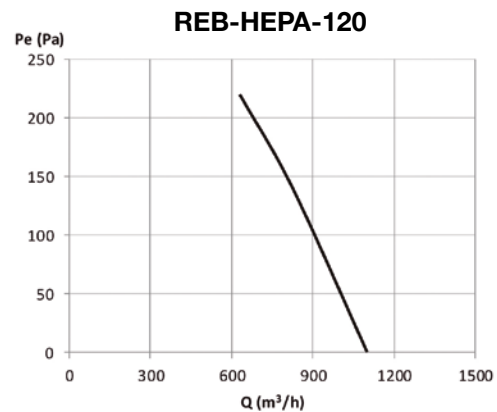
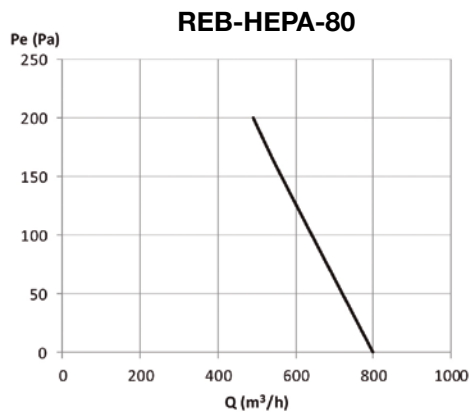
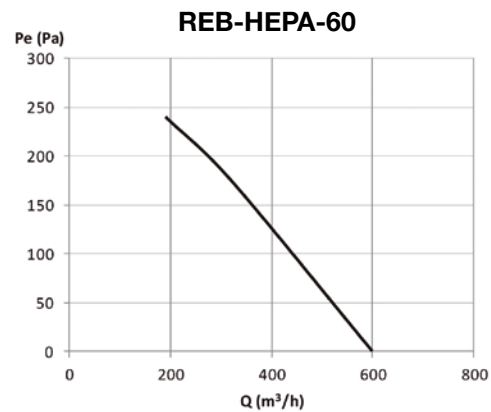
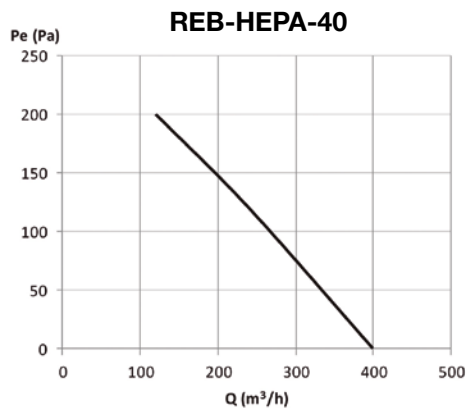

# RECUP/EC-BS



**Heat recovery units with counter flow plate exchanger, automatic control and EC Technology motors, for installation in false ceilings**

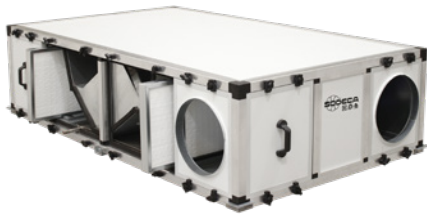

#### Common features:

- EC type Plug Fan adjustable 0-10 V.
- Built-in maintenance disconnect switch.
- Thermal efficiency of the equipment 85-90%.
- Structure with high quality reinforced aluminum profiles.
- Panels with a 25 mm thick thermal and acoustic insulation; exterior made of prefinished sheet.
- EPS type panels with thermal bridge break.
- High efficiency filtration:
  - M6 + F8.
  - F7 + F9.
- Broad access for maintenance.
- Free cooling with motorized damper to perform BY-PASS.
- Condensation collection tray and drain.

- STOP/START and speed control available through control panel or external contacts.
- Built-in temperature and humidity sensors.
- Filters condition check by means of built-in pressure switches.
- Fault alarm management and shutdown due to fire alarm.
- Compatible with MODBUS RTU.

#### Finish:

- Aluminium frame and external prefinished sheet structure.
- 25 mm thermal and acoustic insulation panels.
- Low profile models for false ceiling installation.
- Interchangeable nozzles for better adaptation.

#### Built-in control box:

- Control for free cooling through motorized BY-PASS.
- Fan speed control by manual selection or by optional external sensors (CO2 or pressure).
- Integrated control system with remote control panel.

#### On request:

- External battery modules for air treatment.
- Filters with special efficiencies.
- Modules with UVc germicidal chamber.

## Order code

**RECUP/EC-BS – 800 – BS – M6+F8**

RECUP/EC-BS: Heat recovery units with counter flow plate exchanger, automatic control and EC Technology motors, for installation in false ceilings

Size

Horizontal ducts and installation in false ceilings

Filters M6+F8  
Filters F7+F9

## Characteristics based on size

	RECUP/ EC-800-BS	RECUP/ EC-1200-BS	RECUP/ EC-1600-BS	RECUP/ EC-2100-BS	RECUP/ EC-2700-BS
Supply filter (ODA)	M6+F8 / F7+F9	M6+F8 / F7+F9	M6+F8 / F7+F9	M6+F8 / F7+F9	M6+F8 / F7+F9
Extraction filter (ETA)	M6	M6	M6	M6	M6
Free cooling function by means of a motorised by-pass	YES	YES	YES	YES	YES
Panel thickness	25 mm	25 mm	25 mm	25 mm	25 mm
Condensate exhaust	YES	YES	YES	YES	YES
Built-in pressure switches for filter condition control	YES	YES	YES	YES	YES
Safety and maintenance switch	YES	YES	YES	YES	YES
Built-in control panel	YES	YES	YES	YES	YES

## Technical characteristics

Model	Nominal flow rate (m <sup>3</sup> /h)	Recovery unit efficiency (%)	Available pressure (Pa)	Nominal power (kW)	Nominal current (A)	Voltage 50/60 Hz (V)	Irradiated sound level at 5 m dB (A)	Approx. weight (Kg)	According ErP
RECUP/EC-800-BS	800	86.5	70	0.39	2.91	1/230	45	78	2018
RECUP/EC-1200-BS	1200	86.8	70	0.32	1.16	1/230	34	105	2018
RECUP/EC-1600-BS	1600	86.2	100	0.53	2.11	1/230	40	178	2018
RECUP/EC-2100-BS	2100	88.0	100	0.76	3.14	1/230	43	216	2018
RECUP/EC-2700-BS	2700	86.9	100	1.23	5.17	1/230	50	216	2018



## Erp. (Energy Related Products)

Information on Directive 2009/125/EC can be downloaded from the SODECA website or the QuickFan selector programme.

## Dimensions mm

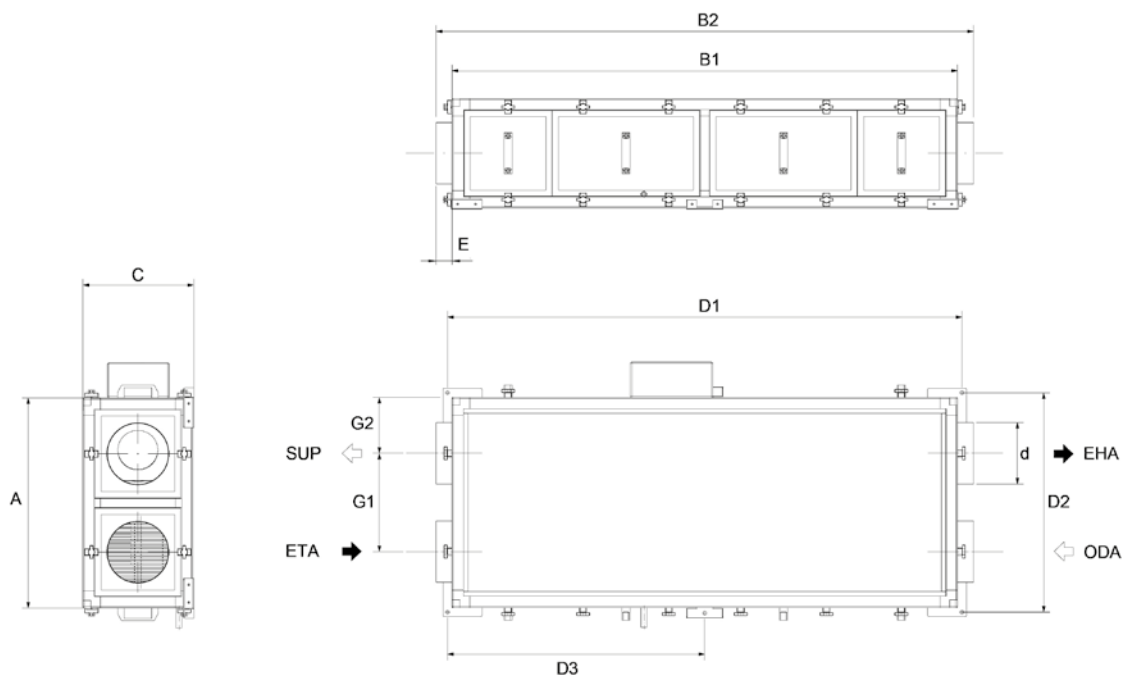

	A	B1	B2	C	D1	D2	D3	E	G1	G2	d
RECUP/EC-800-BS	684	1644	1694	357	1664	704	832	25	320	182	200
RECUP/EC-1200-BS	1124	1890	1940	480	1910	1144	955	25	695	214	315
RECUP/EC-1600-BS	1250	1970	2020	480	1990	1270	995	25	781	235	355
RECUP/EC-2100-BS	1250	2198	2248	620	2218	1270	1109	25	736	257	400
RECUP/EC-2700-BS	1250	2198	2248	620	2218	1270	1109	25	736	257	400

ODA: Fresh outdoor air / SUP: Air impulsion to the premise / EHA: Exit of exhaust air / ETA: Air extraction from premises

## Accessories



## Characteristic curves

Q= Flow rate in m<sup>3</sup>/h, m<sup>3</sup>/s and cfm

Pe= Static pressure in mm H<sub>2</sub>O, Pa and inwg

### RECUP/EC-800-BS

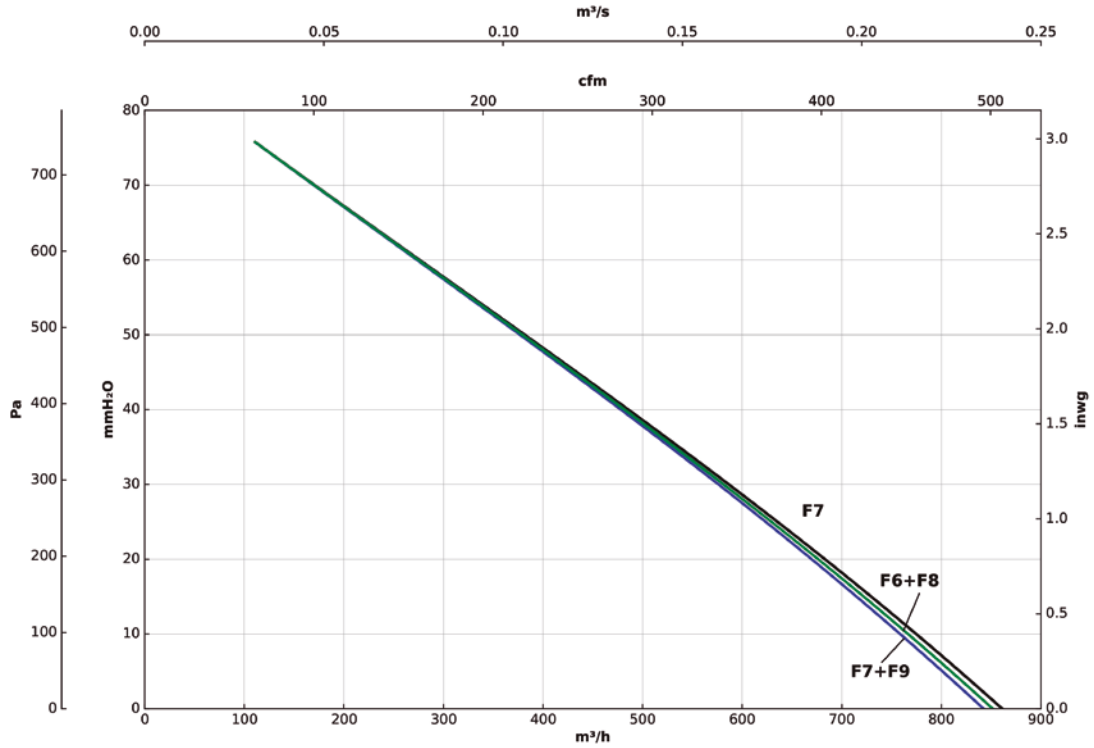

### RECUP/EC-1200-BS

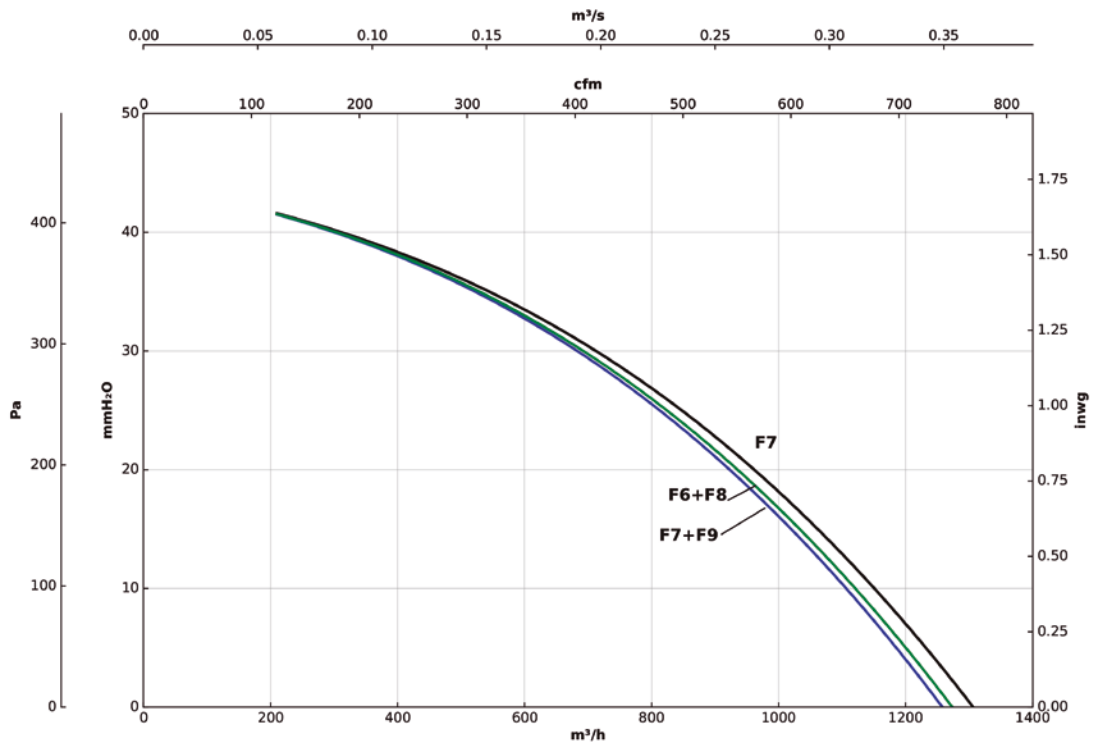

### Characteristic curves

Q= Flow rate in m<sup>3</sup>/h, m<sup>3</sup>/s and cfm

Pe= Static pressure in mm H<sub>2</sub>O, Pa and inwg

#### RECUP/EC-1600-BS

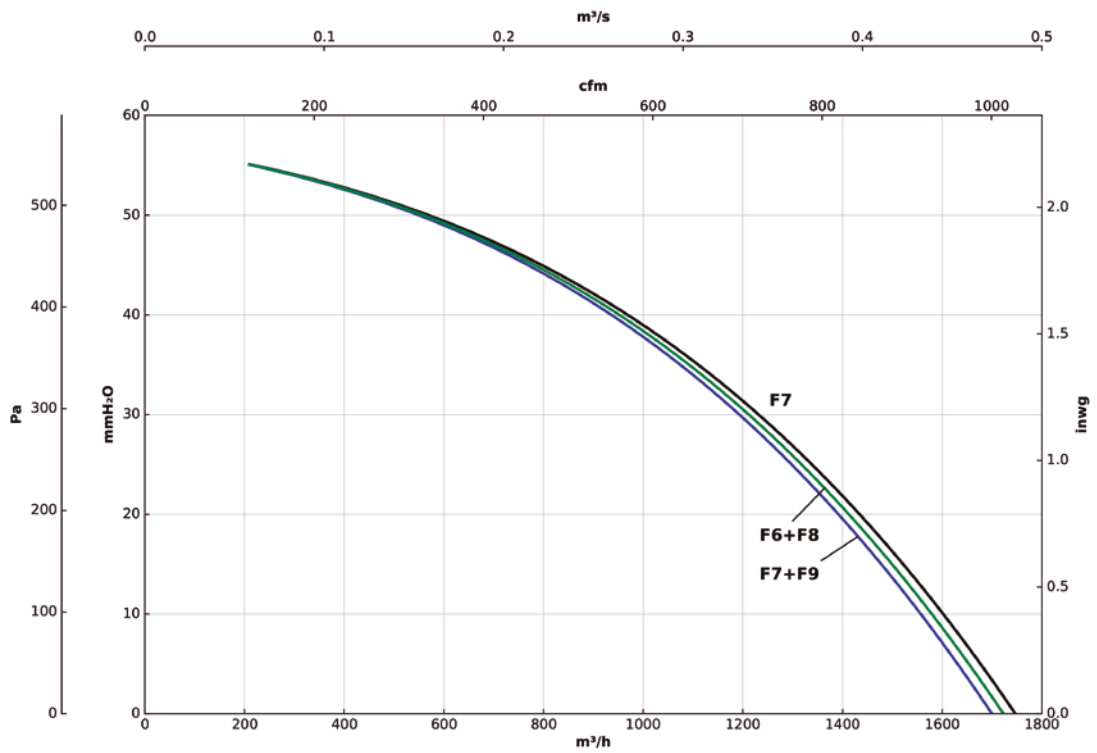

#### RECUP/EC-2100-BS

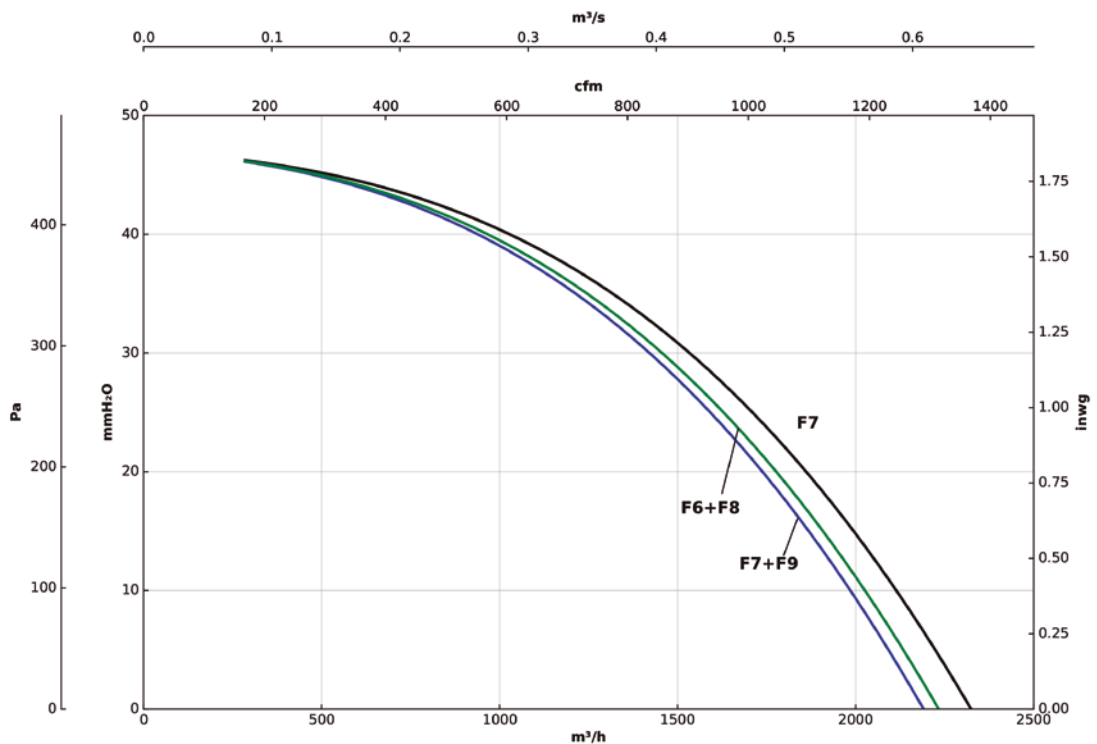

### Characteristic curves

Q= Flow rate in m<sup>3</sup>/h, m<sup>3</sup>/s and cfm

Pe= Static pressure in mm H<sub>2</sub>O, Pa and inwg

#### RECUP/EC-2700-BS

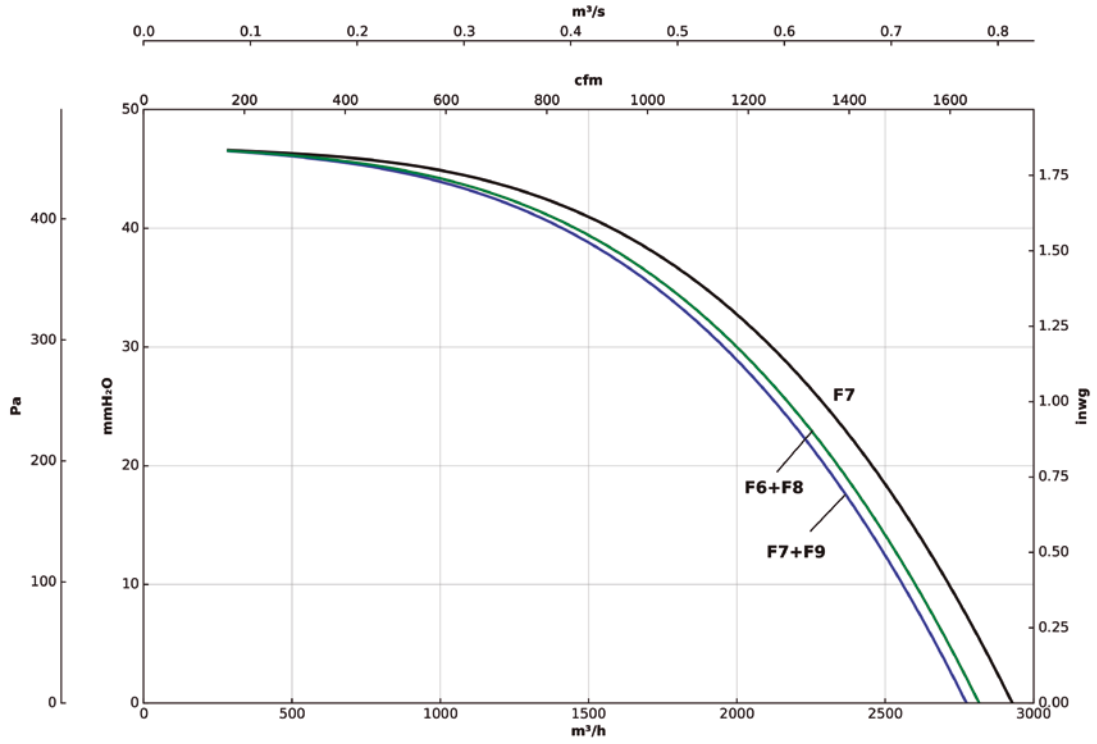

### Efficiency curves

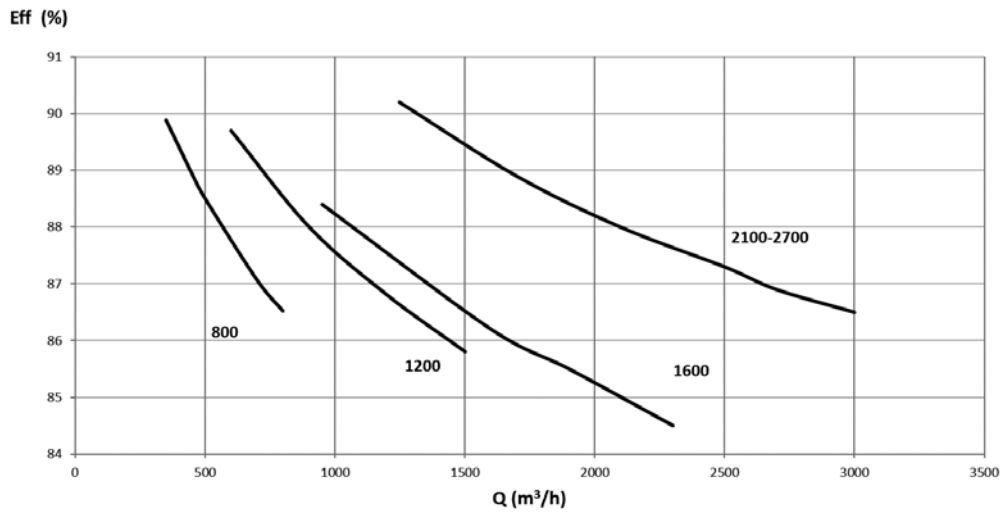

# RECUP/EC-H

Heat recovery units with counter flow exchanger, automatic control and EC Technology motors, for installation on a roof or in a plant room



#### Common features:

- EC type Plug Fan adjustable 0-10 V.
- Built-in maintenance disconnect switch.
- Thermal efficiency of the equipment 85-90%.
- Structure with high quality reinforced aluminum profiles.
- Panels with thermal and acoustic insulation, exterior in pre-lacquered sheet.
- EPS type panels with thermal bridge break.
- G4 pre-filter + M6 or F7 filter in the air supply.
- High efficiency filtration F8 or F9 in the air supply.
- Broad access for maintenance.
- Free cooling with motorized damper to perform BY-PASS.
- Condensation collection tray and drain.

#### Built-in control box:

- Control for free cooling through motorized BY-PASS.
- Fan speed control by manual selection or by optional external sensors (CO2 or pressure).

- Integrated control system with remote control panel.
- STOP/START and speed control available through control panel or external contacts.
- Built-in temperature and humidity sensors.
- Filters condition check by means of built-in pressure switches.
- Fault alarm management and shutdown due to fire alarm.
- Compatible with MODBUS RTU.

#### Finish:

- Structure in aluminum profiles and pre-lacquered outer sheet.
- 25 mm thermal and acoustic insulation panels up to model 2700.
- 50 mm thermal and acoustic insulation panels from model 3300.

#### On request:

- External battery modules for air treatment.
- Filters with special efficiencies.
- Modules with UVc germicidal chamber.

## Order code

**RECUP/EC-H** — **1200** — **H** — **M6+F8**

RECUP/EC-H: Heat recovery units with counter flow exchanger, automatic control and EC Technology motors, for installation on a roof or in a plant room

Size

Horizontal ducts and installation on roofs or in technical rooms

Filters M6+F8  
Filters F7+F9

## Characteristics based on size

	RECUP/ EC-1200-H	RECUP/ EC-1600-H	RECUP/ EC-2100-H	RECUP/ EC-2700-H
Supply filter (ODA)	G4+M6/F7	G4+M6/F7	G4+M6/F7	G4+M6/F7
Impulsion filter (SUP)	F8/F9	F8/F9	F8/F9	F8/F9
Extraction filter (ETA)	M6	M6	M6	M6
Free cooling function by means of a motorised by-pass	YES	YES	YES	YES
Panel thickness	25 mm	25 mm	25 mm	25 mm
Condensate exhaust	YES	YES	YES	YES
Built-in pressure switches for filter condition control	YES	YES	YES	YES
Safety and maintenance switch	YES	YES	YES	YES
Built-in control panel	YES	YES	YES	YES

## Characteristics based on size

	RECUP/ EC-3300-H	RECUP/ EC-4500-H	RECUP/ EC-6000-H	RECUP/ EC-8000-H	RECUP/ EC-10000-H
Supply filter (ODA)	G4+M6/F7	G4+M6/F7	G4+M6/F7	G4+M6/F7	G4+M6/F7
Impulsion filter (SUP)	F8/F9	F8/F9	F8/F9	F8/F9	F8/F9
Extraction filter (ETA)	M6	M6	M6	M6	M6
Free cooling function by means of a motorised by-pass	YES	YES	YES	YES	YES
Panel thickness	50 mm	50 mm	50 mm	50 mm	50 mm
Condensate exhaust	YES	YES	YES	YES	YES
Built-in pressure switches for filter condition control	YES	YES	YES	YES	YES
Safety and maintenance switch	YES	YES	YES	YES	YES
Built-in control panel	YES	YES	YES	YES	YES

## Technical characteristics

Model	Nominal flow rate (m <sup>3</sup> /h)	Recovery unit efficiency (%)	Available pressure (Pa)	Nominal power (kW)	Nominal current (A)	Voltage 50/60 Hz (V)	Irradiated sound level at 5 m dB (A)	Approx. weight (Kg)	According ErP
RECUP/EC-1200-H	1200	90	200	0.45	1.78	1/230	37	210	2018
RECUP/EC-1600-H	1600	88.8	200	0.63	2.54	1/230	40	210	2018
RECUP/EC-2100-H	2100	88.8	200	0.82	1.48	3+N/400	43	281	2018
RECUP/EC-2700-H	2700	87.8	200	1.11	1.88	3+N/400	46	281	2018
RECUP/EC-3300-H	3300	88.8	300	1.68	2.65	3+N/400	50	324	2018
RECUP/EC-4500-H	4500	88.6	300	2.53	4.34	3+N/400	57	342	2018
RECUP/EC-6000-H	6000	89.1	300	2.55	4.26	3+N/400	47	385	2018
RECUP/EC-8000-H	8000	88	300	4.04	6.41	3+N/400	51	385	2018
RECUP/EC-10000-H	10000	87	300	6.11	9.38	3+N/400	56	385	2018



### Erp. (Energy Related Products)

Information on Directive 2009/125/EC can be downloaded from the SODECA website or the QuickFan selector programme.

## Accessories



FILTROS



SI-PRESOSTATO



SI-CO2 IND



CG



## Dimensions mm

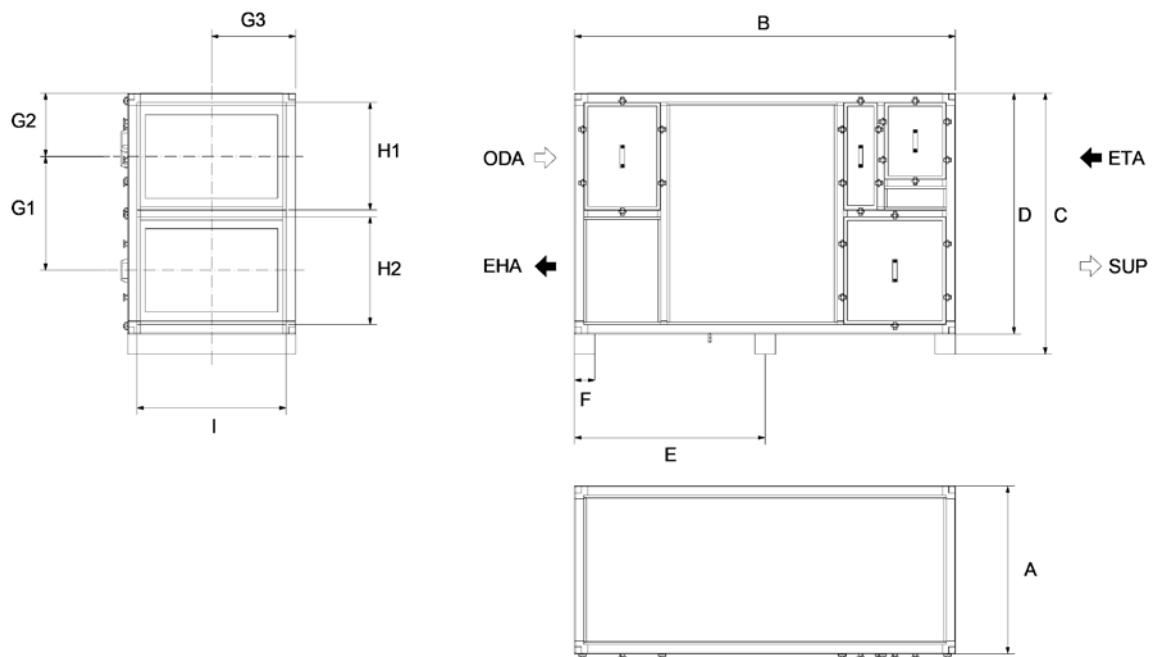

	A	B	C	D	E	F	G1	G2	G3	H1	H2	I
RECUP/EC-1200-H	566	2213	1507	1387	1030	120	672	355	283	637	647	492
RECUP/EC-1600-H	566	2213	1507	1387	1030	120	672	355	283	637	647	492
RECUP/EC-2100-H	669	2213	1507	1387	1030	120	672	355	335	637	647	595
RECUP/EC-2700-H	669	2213	1507	1387	1030	120	672	355	335	637	647	595
RECUP/EC-3300-H	992	2250	1544	1424	1048	120	677	374	496	637	637	881
RECUP/EC-4500-H	1297	2250	1544	1424	1048	120	677	374	649	637	637	1186
RECUP/EC-6000-H	1889	2250	1544	1424	1048	120	677	374	945	637	637	1778
RECUP/EC-8000-H	1889	2250	1544	1424	1048	120	677	374	945	637	637	1778
RECUP/EC-10000-H	1889	2250	1544	1424	1048	120	677	374	945	637	637	1778

ODA: Fresh outdoor air / SUP: Air impulsion to the premise / EHA: Exit of exhaust air / ETA: Air extraction from premises

## Characteristic curves

Q= Flow rate in m<sup>3</sup>/h, m<sup>3</sup>/s and cfm

Pe= Static pressure in mm H<sub>2</sub>O, Pa and inwg

### RECUP/EC-1200-H

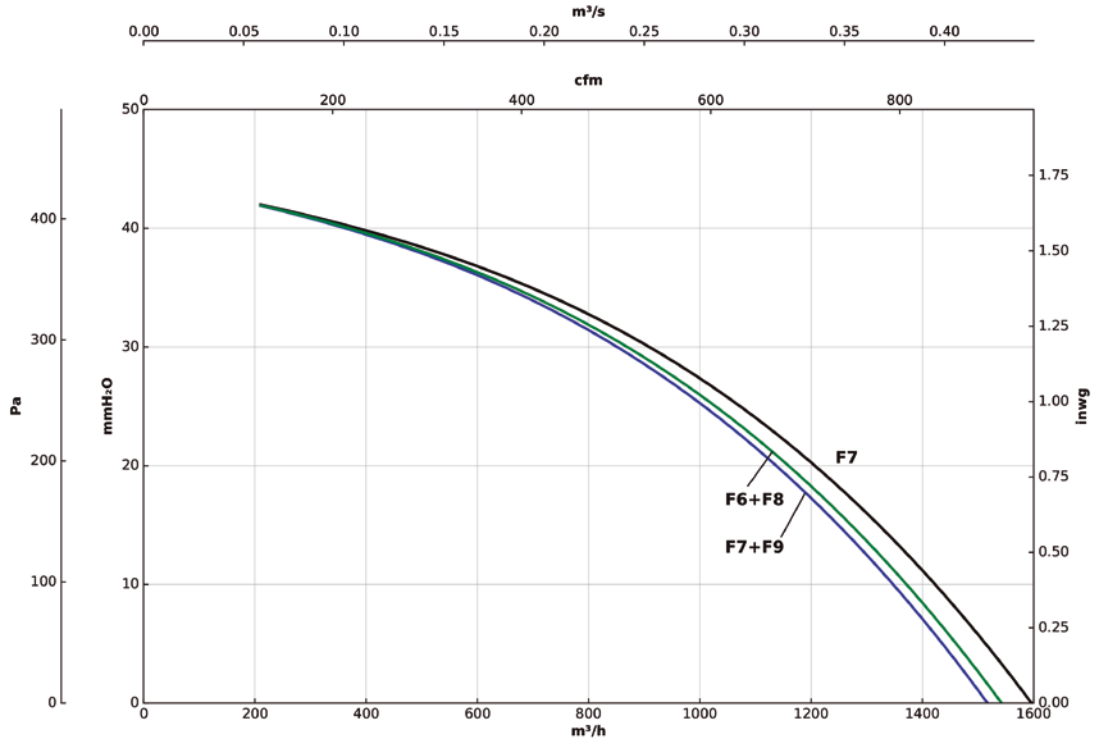

### RECUP/EC-1600-H

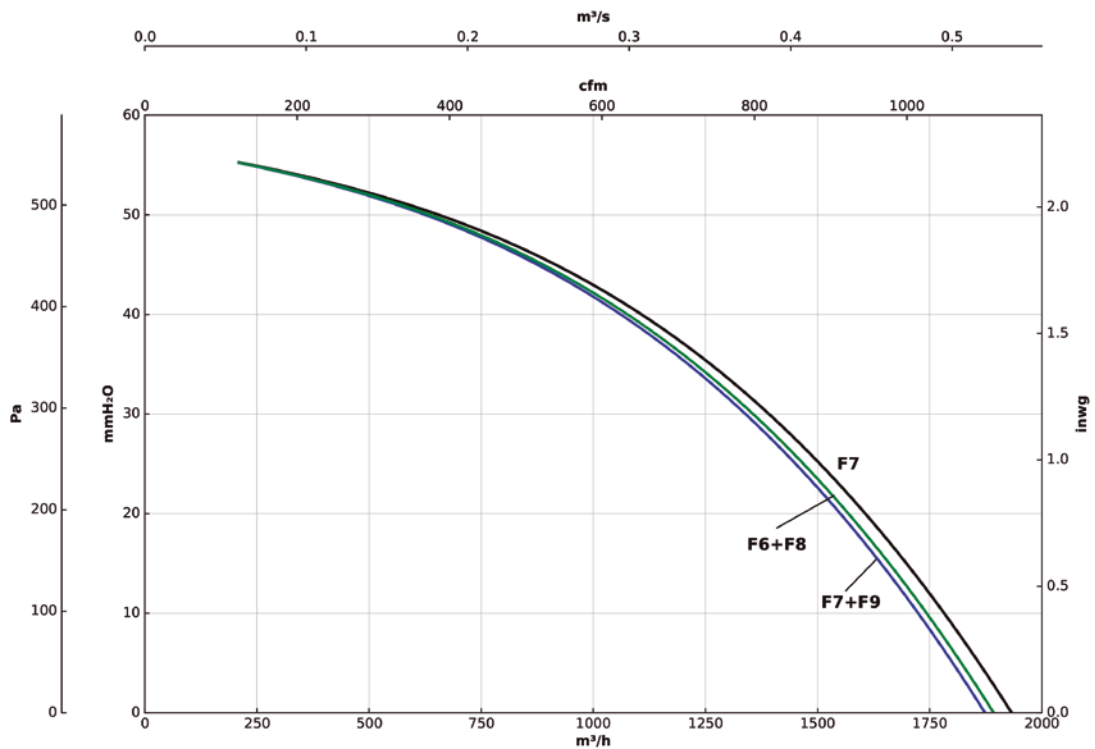

### Characteristic curves

Q= Flow rate in m<sup>3</sup>/h, m<sup>3</sup>/s and cfm

Pe= Static pressure in mm H<sub>2</sub>O, Pa and inwg

#### RECUP/EC-2100-H

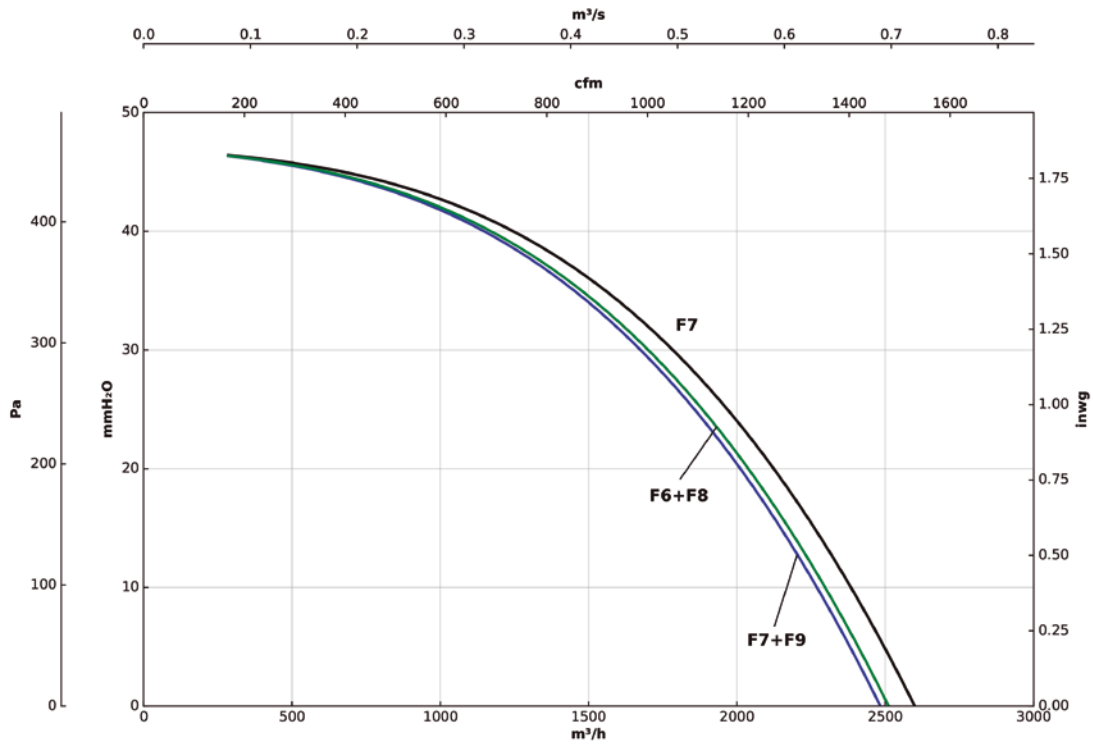

#### RECUP/EC-2700-H

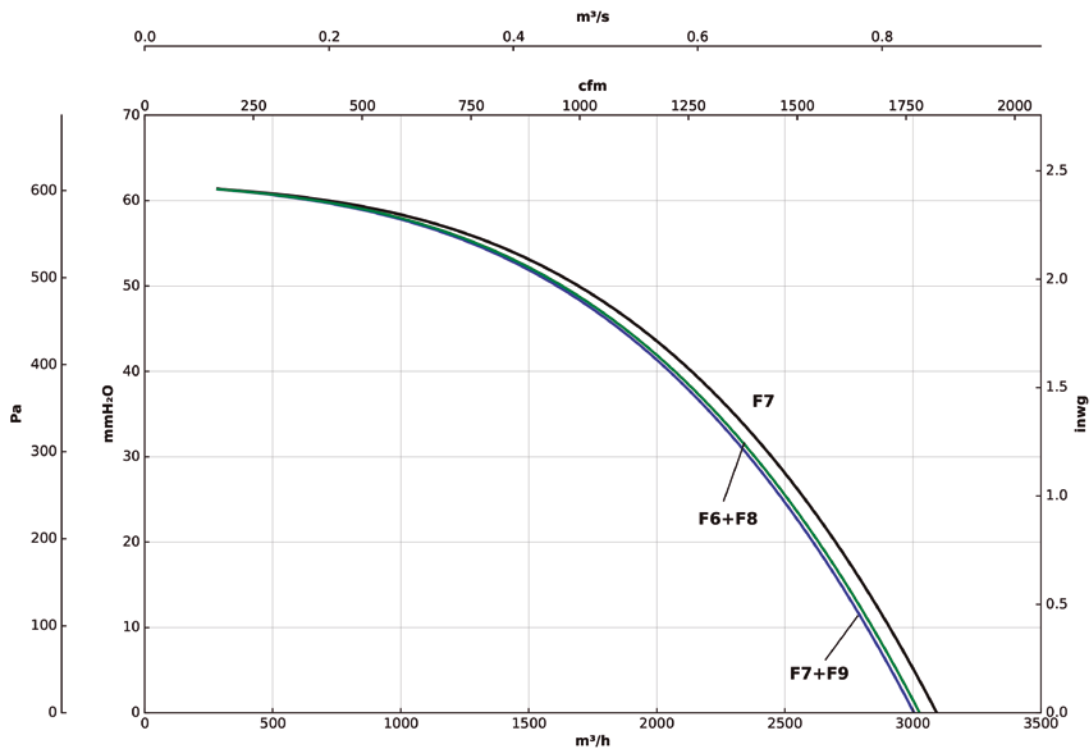

### Characteristic curves

Q= Flow rate in m<sup>3</sup>/h, m<sup>3</sup>/s and cfm

Pe= Static pressure in mm H<sub>2</sub>O, Pa and inwg

#### RECUP/EC-3300-H

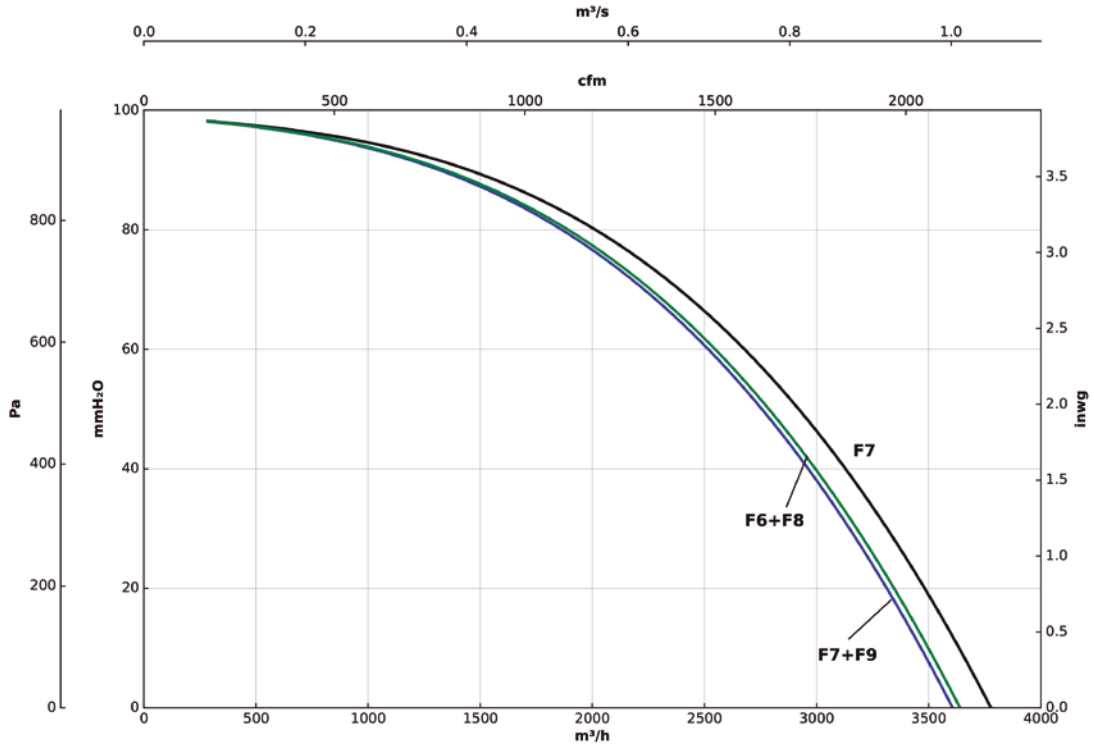

#### RECUP/EC-4500-H

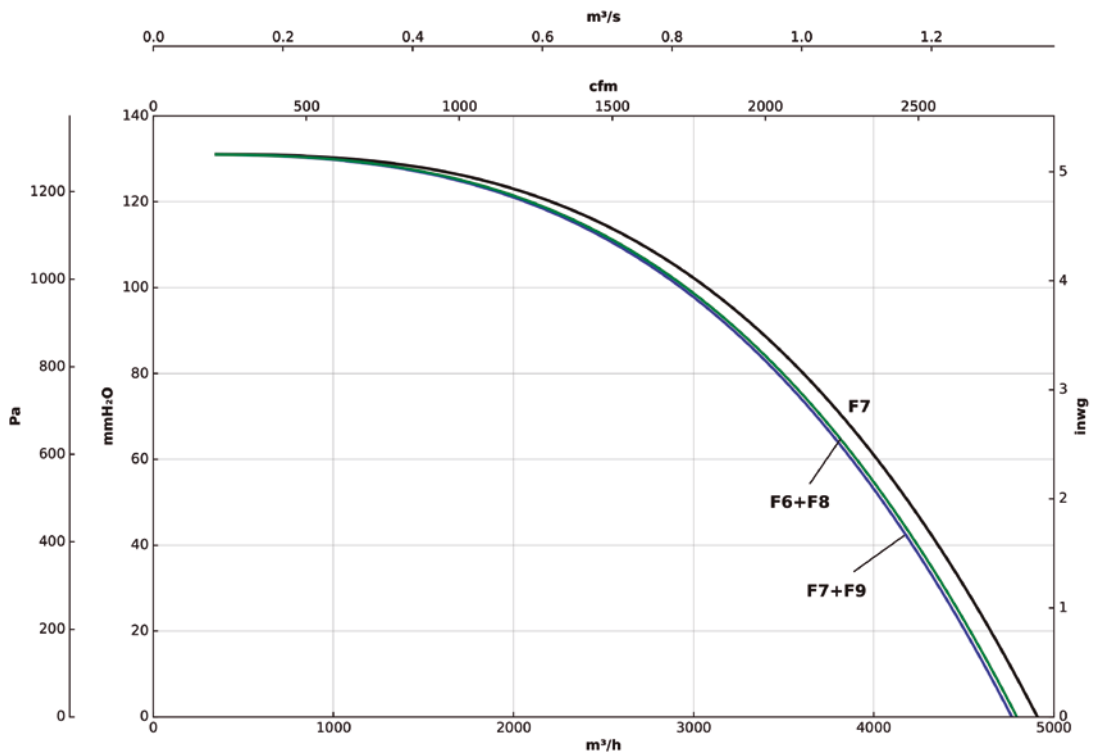

### Characteristic curves

Q= Flow rate in m<sup>3</sup>/h, m<sup>3</sup>/s and cfm

Pe= Static pressure in mm H<sub>2</sub>O, Pa and inwg

#### RECUP/EC-6000-H

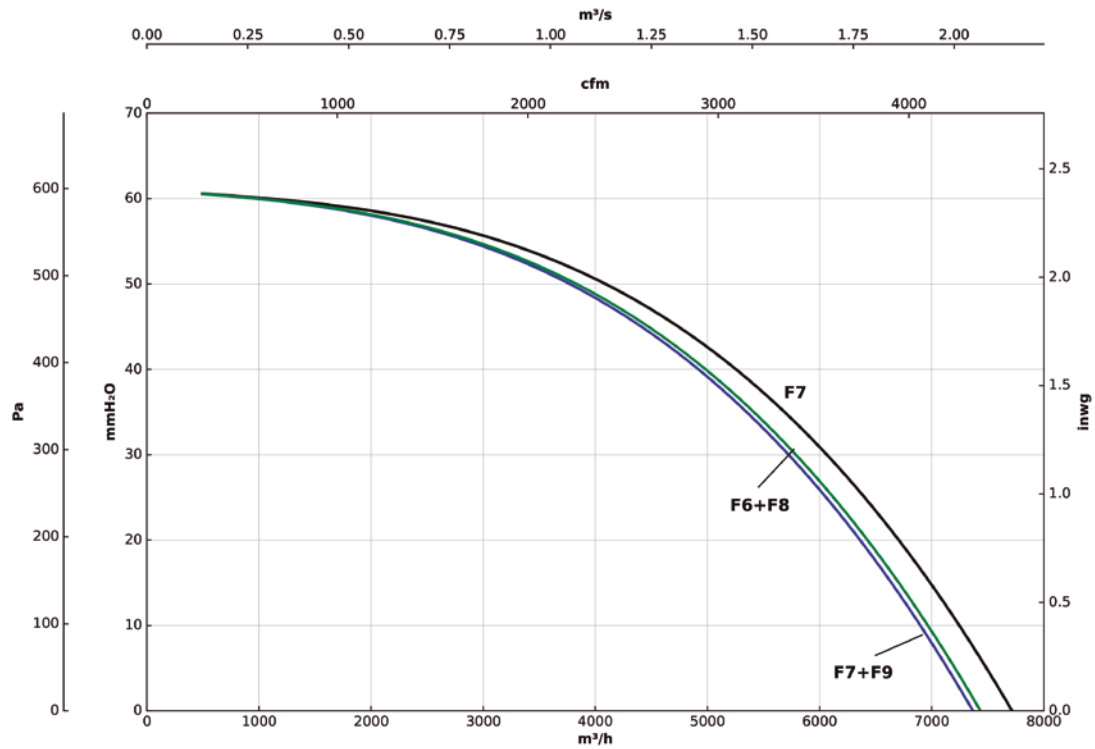

#### RECUP/EC-8000-H

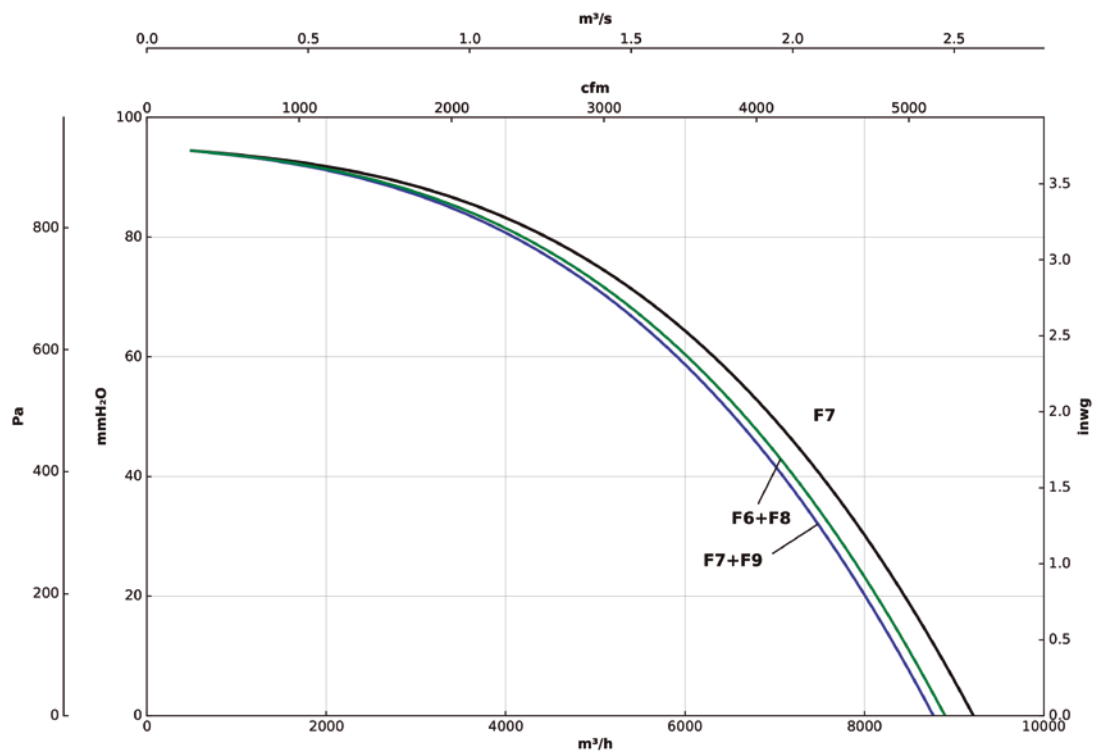

### Characteristic curves

Q= Flow rate in m<sup>3</sup>/h, m<sup>3</sup>/s and cfm

Pe= Static pressure in mm H<sub>2</sub>O, Pa and inwg

#### RECUP/EC-10000-H

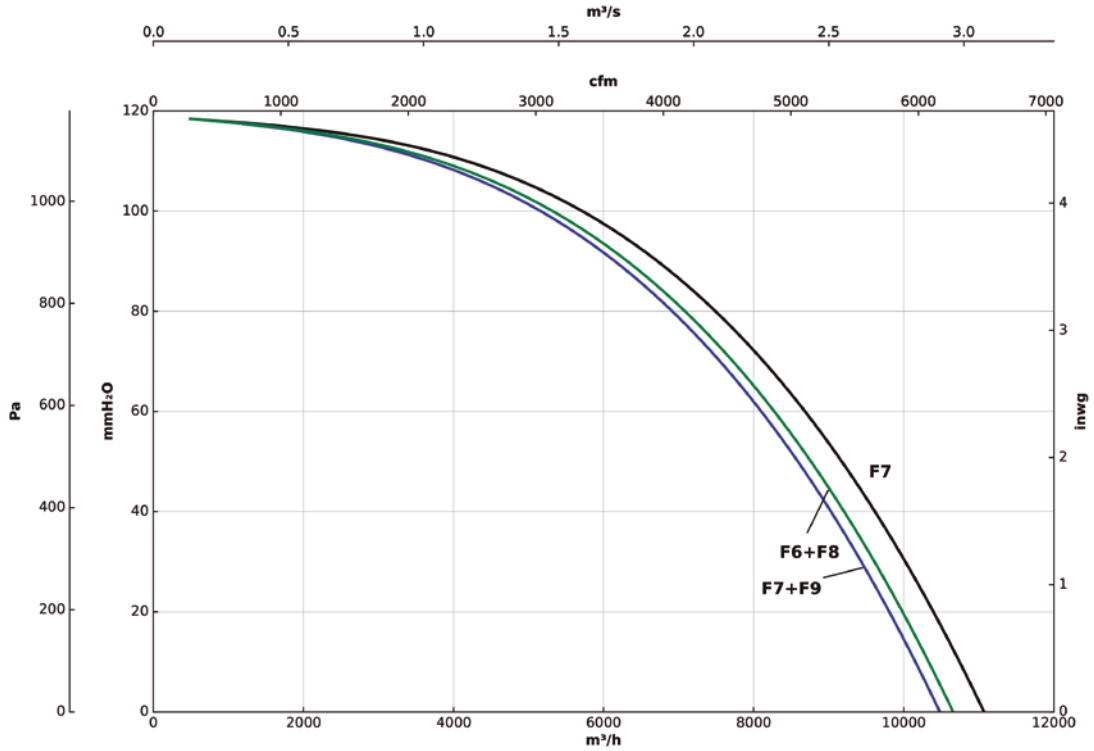

### Efficiency curves

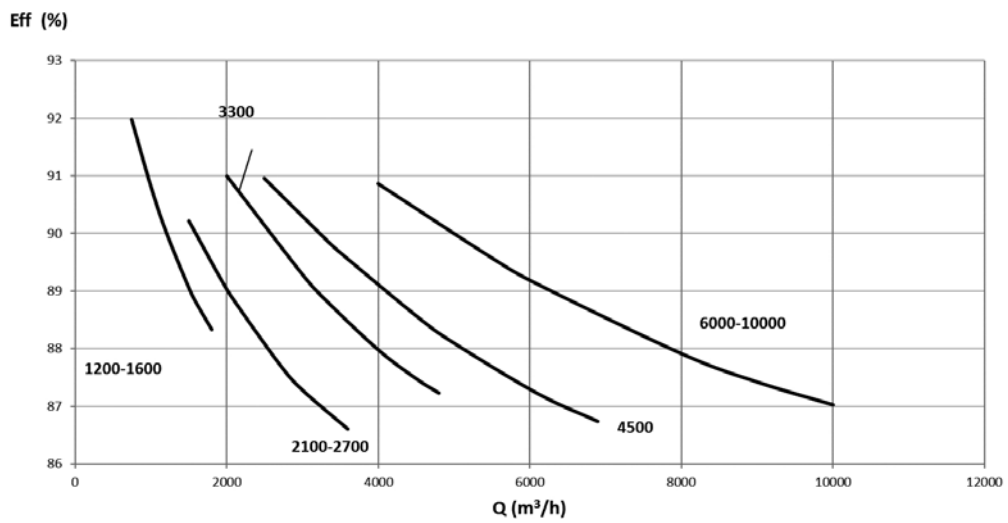

# UPH/EC

Mobile air purifying units

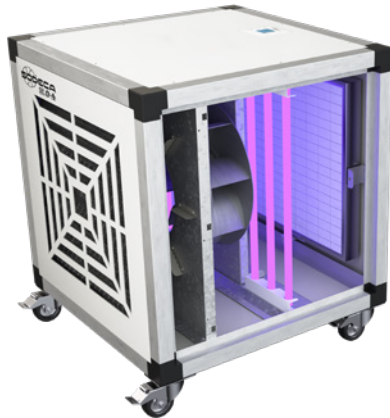
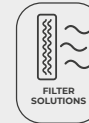

Mobile air purification units with EC Technology motors and a 25 mm thick acoustically insulated casing to reduce noise.

#### Characteristics:

- 40 mm aluminium profile structure.
- Wheel kit.
- Plug & Play system with integrated control.
- Covers with a high quality, 25 mm thick acoustic casing made of prefinished sheet.
- Backward curved impeller.
- Filtration stages, depending on model:
  - F9.
  - HEPA H14.
- Active carbon filter for odour removal.
- Adjustable filter change alarm.
- Germicidal chamber with UVc ultraviolet lamps (256 nm), depending on model.
- Inspection cover for filter maintenance and replacement.

- Air inlet nozzle with diffusers that increase the efficiency of the fan.

#### Motor:

- High efficiency external rotor EC Technology motors, adjustable via 0-10 V signal.
- Single phase 200-240 V 50/60 Hz.
- Maximum temperature of air to be carried: -25 °C +60 °C.

#### Finish:

- Structure of anodised aluminium profiles and pre-lacquered sheet metal with 25 mm thermal and acoustic insulation panels.

#### On request:

- Particle sensor for automatic control.
- Different stages of filtration.

## Order code

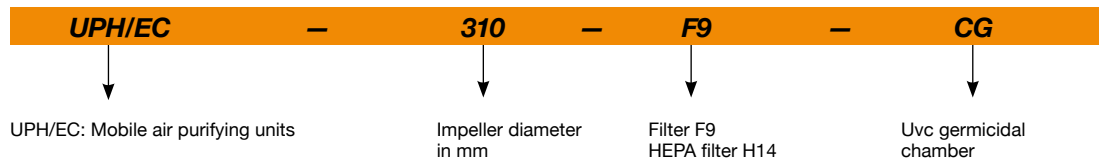

## Filter characteristics

Filters	EN 779 Em	EN 1822	ISO 16890			
			ISO ePM <sub>1</sub>	ISO ePM <sub>2,5</sub>	ISO ePM <sub>10</sub>	ISO COARSE
F9	95%	-	>80%	>95%	>95%	-
HEPA H14	-	>99.995%	-	-	-	-

## Technical characteristics

Model	Recommended effective working area <sup>1</sup> (m <sup>2</sup> )		Speed (r/min)	Maximum power (W)	Power supply	Sound pressure level at 50% of max speed. <sup>2</sup> dB (A)	Maximum flow rate (m <sup>3</sup> /h)		Approx. weight (Kg)
	Filters (F9)	Filters (H14)					Filters (F9)	Filters (H14)	
UPH/EC-220	50	-	3265	176	200-240V 50/60Hz 1Ph	48	420	-	32
UPH/EC-250	60	-	2850	180	200-240V 50/60Hz 1Ph	49	500	-	33
UPH/EC-310	65	55	1920	175	200-240V 50/60Hz 1Ph	47	550	450	34
UPH/EC-400	190	155	1550	460	200-240V 50/60Hz 1Ph	47	1600	1300	68

<sup>1</sup>Recommended effective working area with a 3-meter-high premises.

<sup>2</sup> Irradiated sound pressure level in dB(A) at a distance of 3 m.

## Technical characteristics of the UVC germicidal chamber

According to the model, these purification units can integrate a germicidal chamber, built with UVC ultraviolet lamps in a 256 nm spectrum, a wave width indicated to inactivate a wide variety of microorganisms by absorbing short wavelength energy through DNA and RNA.

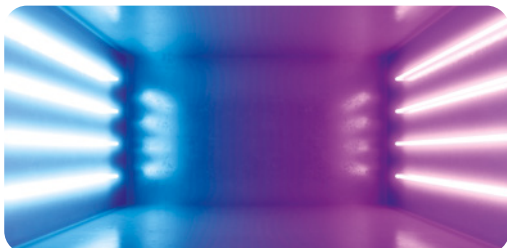

Model	Number of lamps	Total electrical power (W)	Total Uvc radiation power (W)	Radiation dose (mJ/cm <sup>2</sup> ) *
UPH/EC-220	6	54	16.8	7.2
UPH/EC-250	6	54	16.8	6.0
UPH/EC-310	6	54	16.8	6.7
UPH/EC-400	4	102	28	5.4

Minimum dose calculated based on the maximum flow rate.



### Erp. (Energy Related Products)

Information on Directive 2009/125/EC can be downloaded from the SODECA website or the QuickFan selector programme.

## Dimensions mm

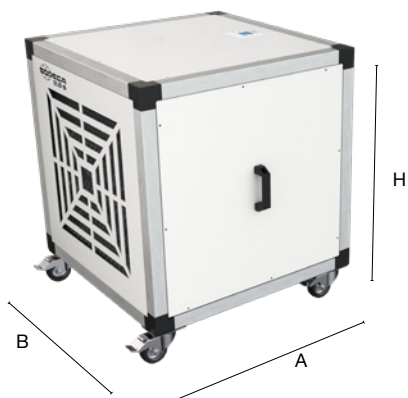

	A	B	H
UPH/EC-220	500	542	642
UPH/EC-250	500	542	642
UPH/EC-310	500	542	642
UPH/EC-400	700	742	842

Data subject to change without prior notice.



# UPA

Units designed for cleaning and purifying indoor air. For use in areas of high occupancy, pharmaceutical industry and hospitals

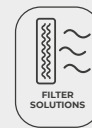

Units specifically designed for cleaning and purifying indoor air, in any type of premises and mainly in areas with high occupancy, also indicated for the pharmaceutical industry and hospital applications.

#### Characteristics:

- Plug Fan type fans with EC Technology.
- Efficient, adjustable and low noise level equipment.
- Filtration stages, depending on model:
- First stage of F7 Filtering.
- Active carbon filter.
- Final filter F9.
- HEPA H14 final filter, 99.99% efficiency.
- UVc germicidal chamber, according to order code.
- Control panel with on/off and dirty filters indicator.
- Led indicator germicidal chamber operation.

- Completely removable for cleaning and maintenance.
- Panels with interior insulation.

#### Motor:

- High efficiency, external rotor, EC Technology motors, incorporating constant flow regulation, with two pre-adjustable set points.
- Single-phase 200-230 V 50/60 Hz.

#### Finish:

- Frames made form aluminum section and 25 mm insulated panels, pre-finished exterior, galvanized interior.

#### On request:

- Drive module 1 front grill.
- Drive module with circular ducts.
- Equipped with wheels.

## Order code

**UPA – UV – 1500 – F9 – CG**

UPA: Units designed for cleaning and purifying indoor air. For use in areas of high occupancy, pharmaceutical industry and hospitals

UV: Vertical unit  
UH: horizontal unit

Air flow rate (m<sup>3</sup>/h)

Filter F9  
HEPA filter H14

Uvc germicidal chamber

## Technical characteristics

Model	Recommended effective working area <sup>1</sup>	Maximum flow rate		Available pressure	Power supply	Noise level	Fan	Approx. weight
	(m <sup>2</sup> )	(m <sup>3</sup> /h)	(cfm)	(Pa)	(V)	(dB (A))	(kW)	(Kg)
UPA-UV-1500	200-350	1,500	883	250	200-230V 50/60Hz 1Ph	47	0.76	113
UPA-UV-3000	300-450	3,000	1766	250	200-230V 50/60Hz 1Ph	51	1.35	140
UPA-UV-4500	450-900	4,500	2649	300	200-230V 50/60Hz 1Ph	55	2.7	177
UPA-UV-6000	900-1,100	6,000	3531	250	200-230V 50/60Hz 1Ph	59	5.4	215
UPA-UH-1500	200-350	1,500	883	250	200-230V 50/60Hz 1Ph	47	0.76	108
UPA-UH-3000	300-450	3,000	1766	250	200-230V 50/60Hz 1Ph	52	1.52	138
UPA-UH-4500	450-900	4,500	2649	250	200-230V 50/60Hz 1Ph	55	2.7	135
UPA-UH-6000	900-1,100	6,000	3531	250	200-230V 50/60Hz 1Ph	59	5.4	155

<sup>1</sup>Recommended effective working area with a 3-meter-high premises.

\*Available pressure with G4 and F9 filter.

## Construction

### Vertical Unit (UV)

Vertical Unit (UV) ideal for direct use on the rooms to be purified, it can also be supplied on request with an impulsion module with outlet through diffusion grille and with wheels if necessary.

### Horizontal Unit (UH)

Horizontal Unit (HU) conceived to be installed in false ceilings and connected through ducts to the premises where the air needs to be treated.

## Dimensions mm

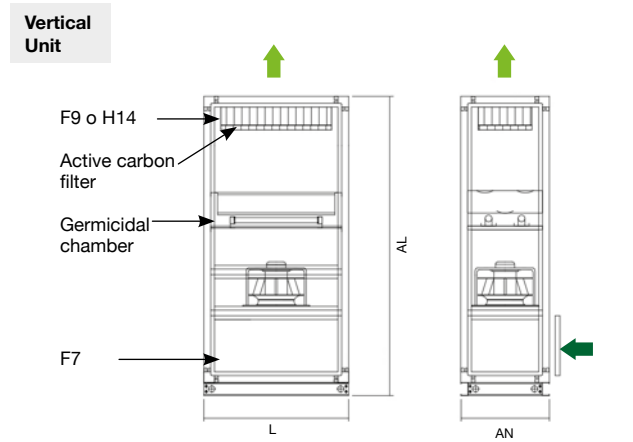

	L	AN	H
UPA-UV-1500	774	474	1600
UPA-UV-3000	774	779	1600
UPA-UV-4500	1079	779	1600
UPA-UV-6000	1504	779	1600

Data subject to change without prior notice.

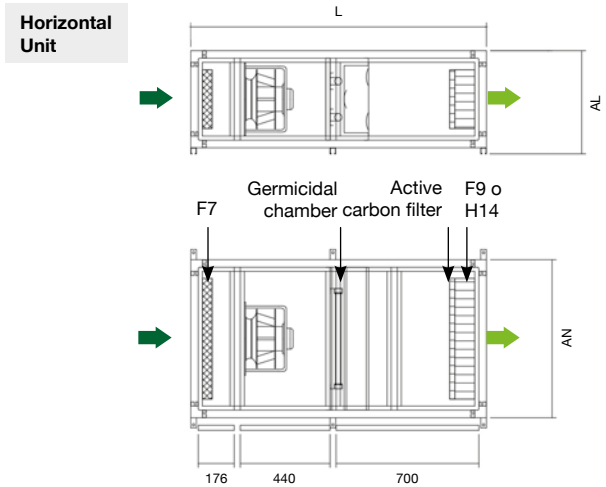

	L	AN	H
UPA-UH-1500	1450	774	479
UPA-UH-3000	1450	1366	479
UPA-UH-4500	1450	1069	779
UPA-UH-6000	1450	1366	779

Data subject to change without prior notice.

## Drive modules

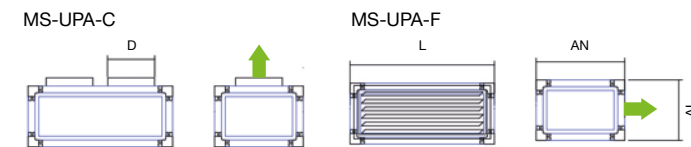

	L	AN	AL	D	Number of ducts	Approx. weight (Kg)
MS-UPA-1500	774	474	324	250	2	25
MS-UPA-3000	774	779	490	250	4	33
MS-UPA-4500	1079	779	490	250	6	42
MS-UPA-6000	1504	779	490	-	-	55

## Filtered

These air purification units are equipped with filters capable of removing at least 70% of particles larger than 0.4µm. The standard model comes with a first G-4 filter stage and a final F-9 filter, it also incorporates as standard, an activated carbon stage, designed to remove stale odours produced during everyday use of the premises. Depending on model type H14 HEPA filters can be installed with a minimum retention capacity of 99.95% for particles larger than 0.3µm.

Filters	EN 779 Em	EN 1822	ISO 16890			
			ISO ePM <sub>1</sub>	ISO ePM <sub>2.5</sub>	ISO ePM <sub>10</sub>	ISO COARSE
G4	90%	-	-	-	-	>90%
F7	90%	-	>50%	>65-95%	>85%	-
F9	95%	-	>80%	>95%	>95%	-
HEPA H14	-	>99.995%	-	-	-	-

## Technical characteristics of the UVc germicidal chamber

According to the model, these purification units can integrate a germicidal chamber, built with UVc ultraviolet lamps in a 256 nm spectrum, a wave width indicated to inactivate a wide variety of microorganisms by absorbing short wavelength energy through DNA and RNA.

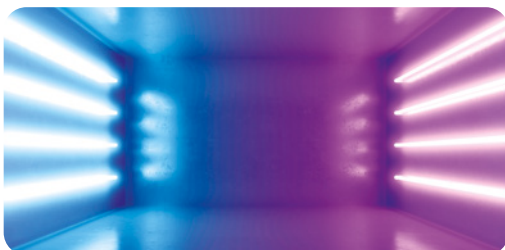

Model	Number of lamps	Total electrical power (W)	Total UVc radiation power (W)	Radiation dose (mJ/cm <sup>2</sup> ) *
CG-UV-1500	3	48	21	4.85
CG-UV-3000	7	112	48	5.66
CG-UV-4500	4	216	70	5.39
CG-UV-6000	14	224	98	5.47
CG-UH-1500	3	48	21	5.17
CG-UH-3000	2	150	51	6.28
CG-UH-4500	4	216	70	5.89
CG-UH-6000	14	224	98	6.04

\*Minimum dose calculated based on flow with filters: F7+F9.

# UPM/EC

Mobile air purifying units, designed for cleaning, odor removal and indoor air purification in any type of premises

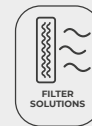

#### Characteristics:

- 40 mm aluminium profile structure.
- Wheel kit.
- Plug & Play system with integrated control.
- Adjustable filter change alarm.
- Covers with a high quality, 25 mm thick acoustic casing made of prefinished sheet.
- Backward curved impeller.
- Dishwasher safe pre-filter.
- Filtration stages, depending on model:
  - F9.
  - HEPA H14.
- Active carbon filter for odour removal.
- Inspection cover for filter maintenance and replacement.
- Germicidal chamber with UVC ultraviolet lamps (256 nm), depending on model.

#### Motor:

- High efficiency external rotor EC Technology motors, adjustable via 0-10 V signal.
- Single phase 200-240 V 50/60 Hz.
- Maximum temperature of air to be carried: -25 °C +60 °C.

#### Finish:

- Structure of anodised aluminium profiles and pre-lacquered sheet metal with 25 mm thermal and acoustic insulation panels.

#### On request:

- Particle sensor for automatic control.
- Different stages of filtration.

## Order code

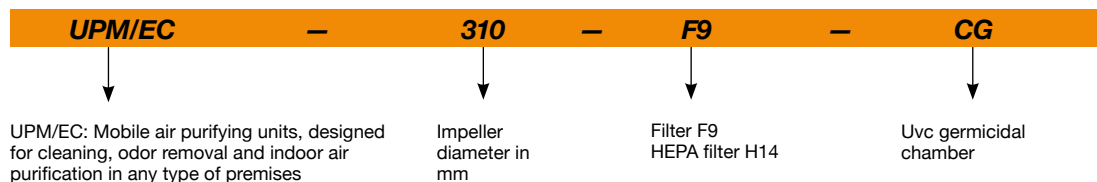

## Filter characteristics

Filters	EN 779 Em	EN 1822	ISO 16890			
			ISO ePM <sub>1</sub>	ISO ePM <sub>2,5</sub>	ISO ePM <sub>10</sub>	ISO COARSE
F9	95%	-	>80%	>95%	>95%	-
HEPA H14	-	>99.995%	-	-	-	-

## Technical characteristics

Model	Recommended effective working area <sup>1</sup> (m <sup>2</sup> )		Speed (r/min)	Maximum power (W)	Power supply	Sound pressure level at 50% of max speed. <sup>2</sup> dB (A)	Maximum flow rate (m <sup>3</sup> /h)		Approx. weight (Kg)
	Filters (F9)	Filters (H14)					Filters (F9)	Filters (H14)	
UPM/EC-310	65	55	1920	175	200-240V 50/60Hz 1Ph	47	550	450	55
UPM/EC-310/H	115	90	2377	450	200-240V 50/60Hz 1Ph	55	950	750	57
UPM/EC-400	190	155	1550	460	200-240V 50/60Hz 1Ph	47	1600	1300	69

<sup>1</sup>Recommended effective working area with a 3-meter-high premises.

<sup>2</sup>Irradiated sound pressure level in dB(A) at a distance of 3 m.

## Technical characteristics of the UVC germicidal chamber

According to the model, these purification units can integrate a germicidal chamber, built with UVC ultraviolet lamps in a 256 nm spectrum, a wave width indicated to inactivate a wide variety of microorganisms by absorbing short wavelength energy through DNA and RNA.

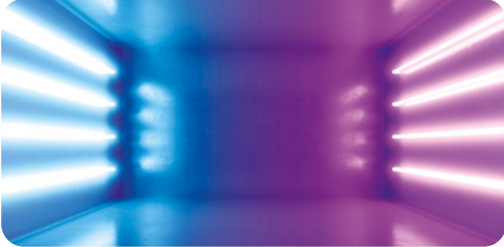

Model	Number of lamps	Total electrical power (W)	Total Uvc radiation power (W)	Radiation dose (mJ/cm <sup>2</sup> ) *
UPM/EC-310	6	54	16.8	6.7
UPM/EC-310/H	6	54	16.8	4.5
UPM/EC-400	4	102	28	5.4

\*Minimum dose calculated based on flow with filters: H14.



### Erp. (Energy Related Products)

Information on Directive 2009/125/EC can be downloaded from the SODECA website or the QuickFan selector programme.

## Dimensions mm

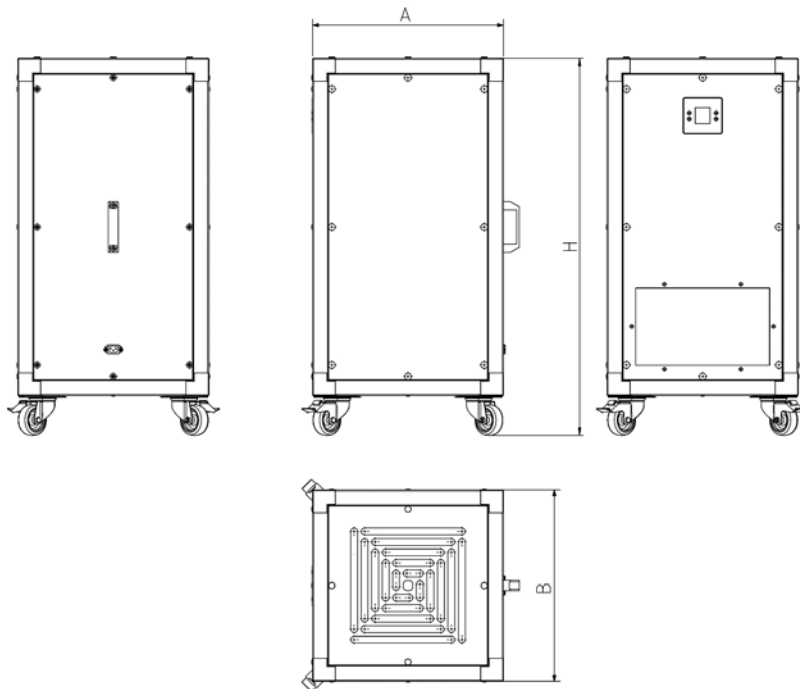

	A	B	H
UPM/EC-310	500	500	985
UPM/EC-400	701	701	1186

# UPM/EC PCO

Mobile air purifying units with photocatalysis-based technology

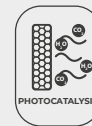

Mobile air purification units with technology based on photocatalysis, designed for disinfecting and purifying indoor air and surfaces in any type of high occupancy premise.

**Characteristics:**

- 40 mm aluminium profile structure.
- Wheel kit.
- Plug & Play system with integrated control.
- Adjustable filter change alarm.
- Covers with a high quality, 25 mm thick acoustic casing made of prefinished sheet.
- Backward curved impeller.
- Washable pre-filter.
- Built-in photocatalyst device with negative ionisation.
- Additional filtration stages: F7 + HEPA H14.

- Inspection cover for filter maintenance and replacement.

**Motor:**

- High efficiency EC Technology motors, outer rotor adjustable via 0-10 V signal.
- Single-phase 200-240 V 50/60 Hz and three-phase 380-480 V 50/60 Hz.
- Maximum temperature of air to be carried: -25 °C +60 °C.

**Finish:**

- Structure of anodised aluminium profiles and pre-lacquered sheet metal with 25 mm thermal and acoustic insulation panels.

**On request:**

- Particulate matter sensor for automatic control SI-PM2.5+VOC or SI-CO2+VOC.

## Order code

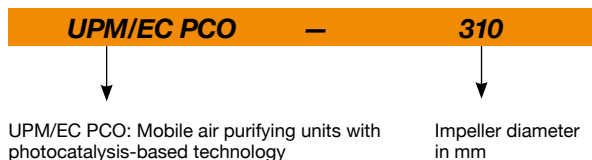

## Filter characteristics

STANDARD FILTERS	EN 779 <i>Em</i>	EN 1822	ISO 16890			
			ISO ePM <sub>1</sub>	ISO ePM <sub>2,5</sub>	ISO ePM <sub>10</sub>	ISO COARSE
F7	90%	-	>50%	>65%	>85%	-
H14	-	>99.995%	-	-	-	-

## Technical characteristics

Model	Recommended effective working area <sup>1</sup> (m <sup>2</sup> )	Speed (r/min)	Power (W)	Power supply	Sound pressure level at 50% of max speed. <sup>2</sup> dB (A)	Maximum flow rate (m <sup>3</sup> /h)	Approx. weight (Kg)
UPM/EC PCO-310	100	2377	450	200-240V 50/60Hz 1Ph	55	800	56
UPM/EC PCO-400	160	1550	460	200-240V 50/60Hz 1Ph	47	1300	98
UPM/EC PCO-500	240	1250	1150	380-480V 50/60Hz 3Ph	51	1950	166

<sup>1</sup>Recommended effective working area with a 3-meter-high premises.

<sup>2</sup> Irradiated sound pressure level in dB(A) at a distance of 3 m.



## Erp. (Energy Related Products)

Information on Directive 2009/125/EC can be downloaded from the SODECA website or the QuickFan selector programme.

### Dimensions mm

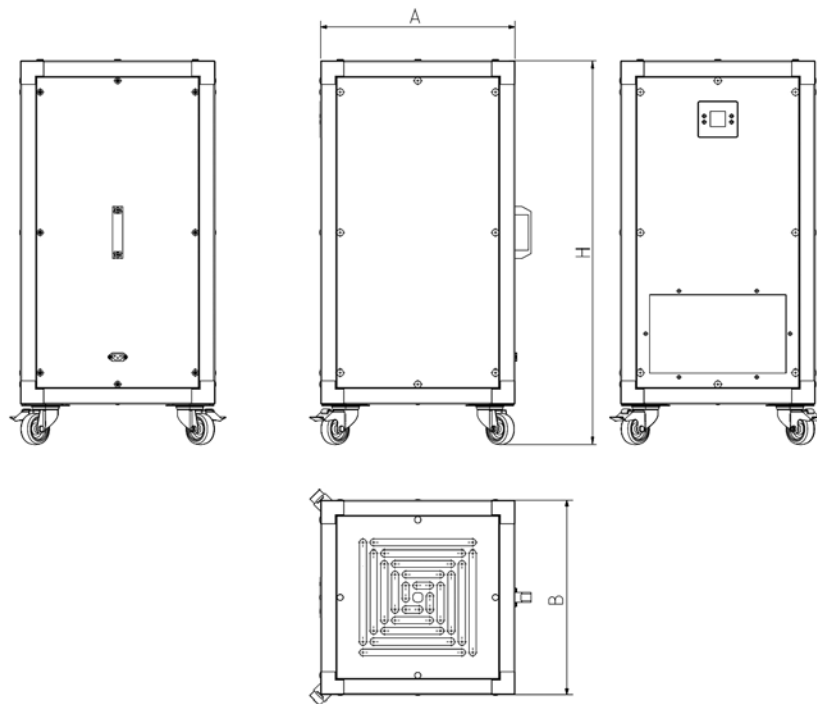

	A	B	H
UPM/EC PCO-310	500	500	985
UPM/EC PCO-400	701	701	1186
UPM/EC PCO-500	901	901	1386

# UPM/EC FE

Mobile air purifying units with high-efficiency electrostatic filters. For use in applications with greasy particles

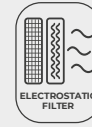

Air purifier units with high efficiency electrostatic filters, specifically designed for cleaning and purifying indoor areas where large amounts of grease or suspended particulate matter can be present.

#### Characteristics:

- 40 mm aluminium profile structure.
- Wheel kit.
- Plug & Play system with integrated control.
- Adjustable filter change alarm.
- Covers with a high quality, 25 mm thick acoustic casing made of prefinished sheet.
- Backward curved impeller.
- Washable pre-filter.
- High efficiency (95% ePM1) electrostatic filter device with built-in thermal sensor.
- Additional active carbon filter stage.
- Inspection cover for filter maintenance and replacement.
- Grease-collection tray.

#### Motor:

- High efficiency EC Technology motors, outer rotor adjustable via 0-10 V signal.
- Single-phase 200-240 V 50/60 Hz and three-phase 380-480 V 50/60 Hz.
- Maximum temperature of air to be carried: -25 °C +60 °C.

#### Finish:

- Structure of anodised aluminium profiles and pre-lacquered sheet metal with 25 mm thermal and acoustic insulation panels.

#### On request:

- Negative ion ioniser.
- Particulate matter sensor for automatic control SI-PM2.5+VOC or SI-CO2+VOC.

## Order code

UPM/EC FE

—

310

UPM/EC FE: Mobile air purifying units with high-efficiency electrostatic filters. For use in applications with greasy particles

Impeller diameter in mm

## Filter characteristics

ELECTROSTATIC FILTER	ePM <sub>1</sub>				
	95%	90%	80%	70%	
Filtration class EN 779	-	-	F9	F8	F7
Air speed (m/s)	1	2	2.5	3	4
Air flow capacity (%)	40	50	65	75	100
Pressure drop (Pa)	10	17	24	37	64

ACTIVE CARBON FILTER	EN 779	EN 1822	ISO 16890			
	Em		ISO ePM <sub>1</sub>	ISO ePM <sub>2.5</sub>	ISO ePM <sub>10</sub>	ISO COARSE
FCA	90%	-	-	-	-	60%

## Technical characteristics

Model	Recommended effective working area <sup>1</sup> (m <sup>2</sup> )		Speed (r/min)	Power (W)	Power supply	Sound pressure level at 50% of max speed. <sup>2</sup> (dB (A))	Maximum flow rate (m <sup>3</sup> /h)		Approx. weight (Kg)
	Grease particles	Dry particles					Grease particles	Dry particles	
UPM/EC FE-310	65	85	1920	175	200-240V 50/60Hz 1Ph	47	525	700	60
UPM/EC FE-400	195	245	1550	460	200-240V 50/60Hz 1Ph	47	1575	2000	111
UPM/EC FE-500	315	385	1250	1150	380-480V 50/60Hz 3Ph	51	2550	3120	184

<sup>1</sup>Recommended effective working area with a 3-meter-high premises.

<sup>2</sup>Irradiated sound pressure level in dB(A) at a distance of 3 m.



## Erp. (Energy Related Products)

Information on Directive 2009/125/EC can be downloaded from the SODECA website or the QuickFan selector programme.

### Dimensions mm

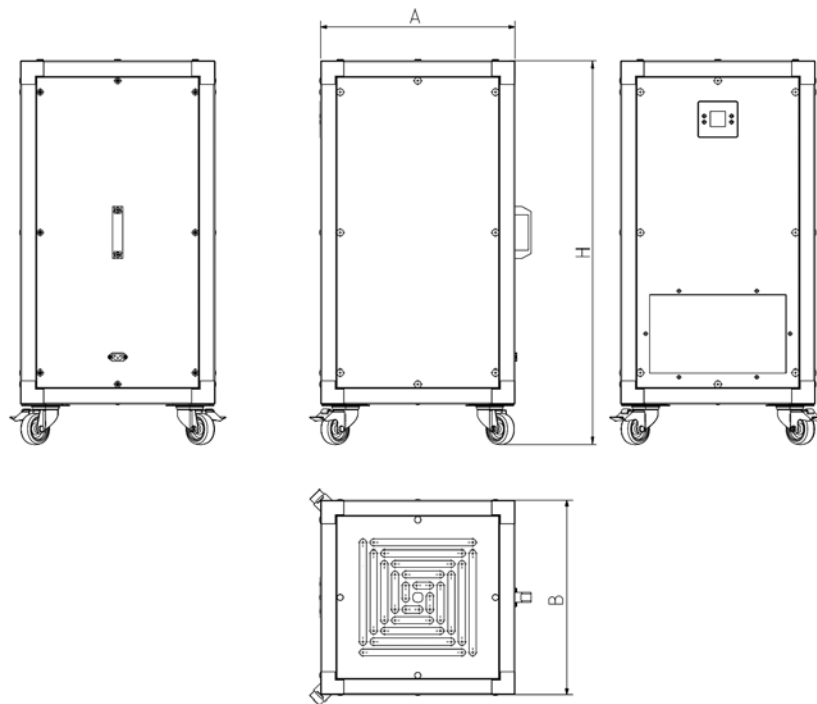

	<b>A</b>	<b>B</b>	<b>H</b>
UPM/EC FE-310	500	500	985
UPM/EC FE-400	701	701	1186
UPM/EC FE-500	901	901	1386



# CJK/FILTER/EC

*Air purifying units for circular ducts, 25 mm acoustic casing, EC Technology motor*

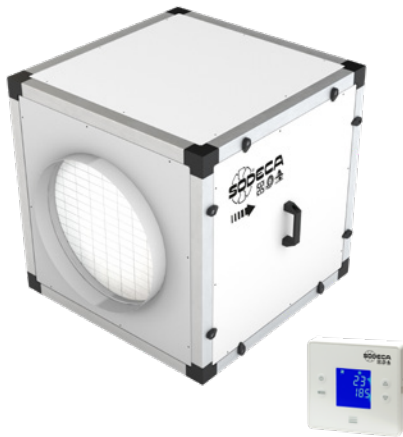
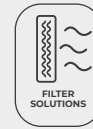

#### Characteristics:

- 40 mm aluminium profile structure.
- Covers with a high quality, 25 mm thick acoustic casing made of prefinished sheet.
- Backward curved impeller.
- Standardised inlet and outlet flanges allowing for easy installation in ducts.
- Filtration stages, depending on model:
  - F7 + F9.
  - F7 + HEPA H14.
- Active carbon filter for odour removal.
- Adjustable filter change alarm.
- Germicidal chamber with UVC ultraviolet lamps (256 nm), depending on model.
- Inspection cover for filter maintenance and replacement.
- Air inlet nozzle with diffusers that increase the efficiency of the fan.

#### Motor:

- High efficiency external rotor EC Technology motors, adjustable via 0-10 V signal.
- Single-phase 200-240 V 50/60 Hz and three-phase 380-480 V 50/60 Hz.
- Maximum temperature of air to be carried: -25 °C +60 °C.

#### Finish:

- Aluminium profile and prefinished sheet steel structure with 25 mm thick thermal and acoustic insulation panels.

#### On request:

- Particle sensor for automatic control.

### Order code

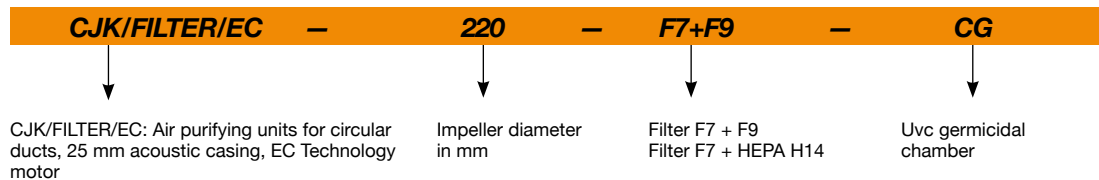

### Filter characteristics

Filters	EN 779	EN 1822	ISO 16890			
	Em		ISO ePM <sub>1</sub>	ISO ePM <sub>2,5</sub>	ISO ePM <sub>10</sub>	ISO COARSE
F7	90%	-	>50%	>65-95%	>85%	-
F9	95%	-	>80%	>95%	>95%	-
HEPA H14	-	>99.995%	-	-	-	-

### Technical characteristics

Model	Recommended effective working area <sup>1</sup> (m <sup>2</sup> )		Speed (r/min)	Maximum power (W)	Power supply	Sound pressure level at 50% of max speed. <sup>2</sup> (dB (A))	Maximum flow rate (m <sup>3</sup> /h)		Approx. weight (Kg)
	Filters (F7+F9)	Filters (F7+H14)					Filters (F7+F9)	Filters (F7+H14)	
CJK/FILTER/EC-220	50	-	3265	176	200-240V 50/60Hz 1Ph	48	420	-	32
CJK/FILTER/EC-250	60	-	2850	180	200-240V 50/60Hz 1Ph	49	500	-	33
CJK/FILTER/EC-310	65	55	1920	175	200-240V 50/60Hz 1Ph	47	550	450	34
CJK/FILTER/EC-400	190	155	1550	460	200-240V 50/60Hz 1Ph	47	1600	1300	68
CJK/FILTER/EC-500	270	230	1250	1150	380-480V 50/60Hz 3Ph	51	2250	1950	118

<sup>1</sup>Recommended effective working area with a 3-meter-high premises.

<sup>2</sup> Irradiated sound pressure level in dB(A) at a distance of 3 m.

## Technical characteristics of the UVC germicidal chamber

According to the model, these purification units can integrate a germicidal chamber, built with UVC ultraviolet lamps in a 256 nm spectrum, a wave width indicated to inactivate a wide variety of microorganisms by absorbing short wavelength energy through DNA and RNA.

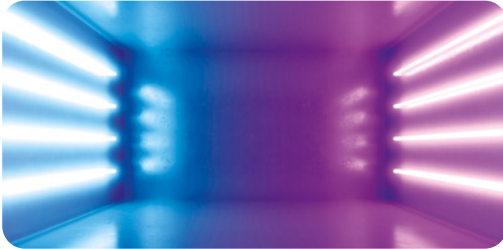

Model	Number of lamps	Total electrical power (W)	Total Uvc radiation power (W)	Radiation dose (mJ/cm <sup>2</sup> )*
CJK/FILTER/EC-220	6	54	16.8	7.2
CJK/FILTER/EC-250	6	54	16.8	6.0
CJK/FILTER/EC-310	6	54	16.8	6.7
CJK/FILTER/EC-400	4	102	28	5.4
CJK/FILTER/EC-500	6	153	42	7.0

\*Minimum dose calculated based on the maximum flow rate.



## Erp. (Energy Related Products)

Information on Directive 2009/125/EC can be downloaded from the SODECA website or the QuickFan selector programme.

## Acoustic characteristics

Sound power spectrum Lw(A) in dB(A) per Hz frequency band  
Irradiated values at maximum speed and medium flow rate.

	63	125	250	500	1000	2000	4000	8000
CJK/FILTER/EC-220	63	65	63	58	55	51	45	35
CJK/FILTER/EC-250	64	66	64	59	56	52	46	36
CJK/FILTER/EC-310	62	64	62	57	54	50	44	34
CJK/FILTER/EC-400	66	61	56	53	54	49	43	32
CJK/FILTER/EC-500	69	65	60	61	61	58	59	54

## Dimensions mm

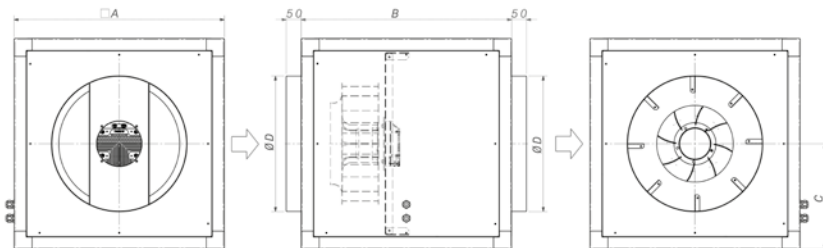

	A	B	C	ØD
CJK/FILTER/EC-220	500	500	250	315
CJK/FILTER/EC-250	500	500	250	355
CJK/FILTER/EC-310	500	500	250	355
CJK/FILTER/EC-400	700	700	350	450
CJK/FILTER/EC-500	900	900	450	500

## Accessories



### Characteristic curves

Q= Flow rate in m<sup>3</sup>/h, m<sup>3</sup>/s and cfm

Pe= Static pressure in mm H<sub>2</sub>O, Pa and inwg

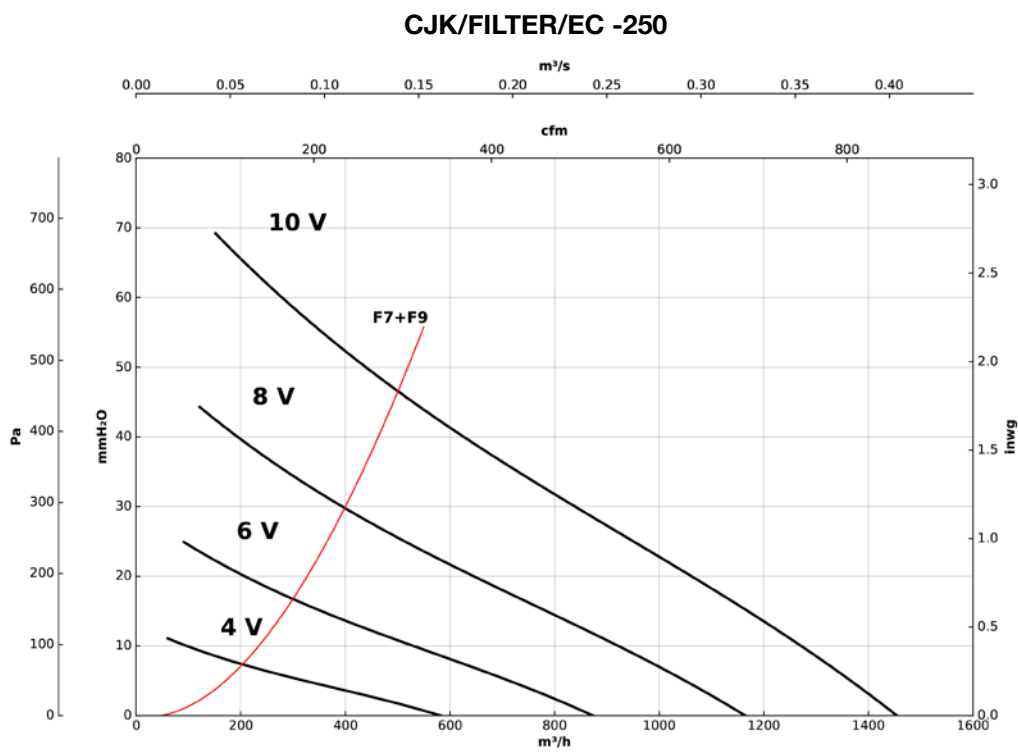
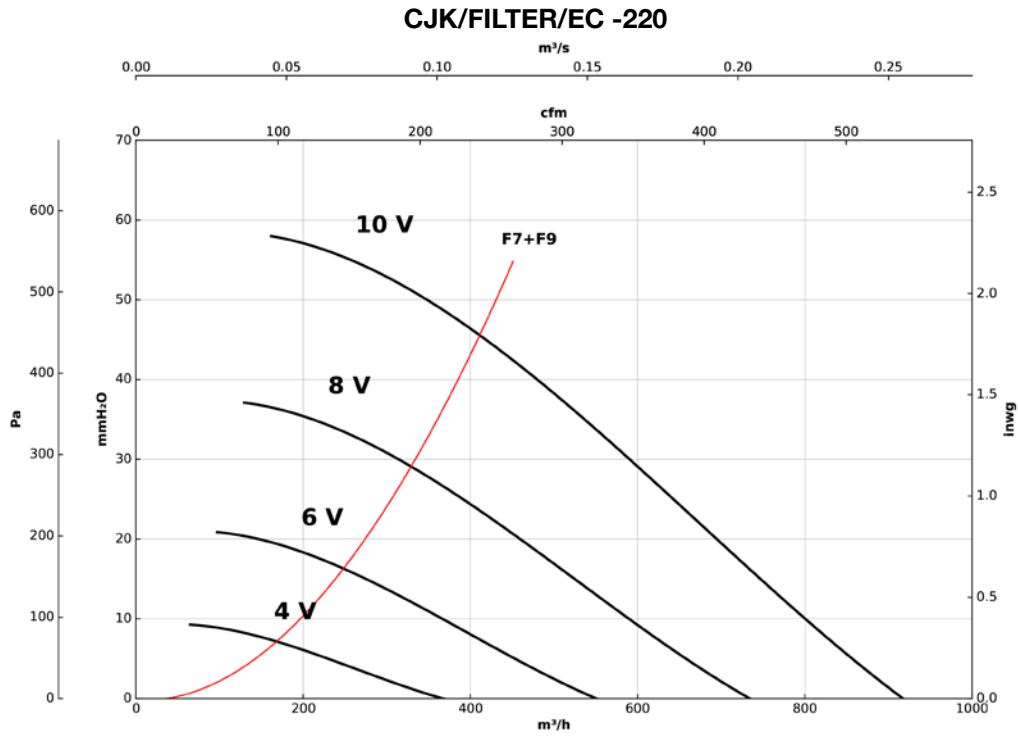

### Characteristic curves

Q= Flow rate in m<sup>3</sup>/h, m<sup>3</sup>/s and cfm

Pe= Static pressure in mm H<sub>2</sub>O, Pa and inwg

#### CJK/FILTER/EC -310

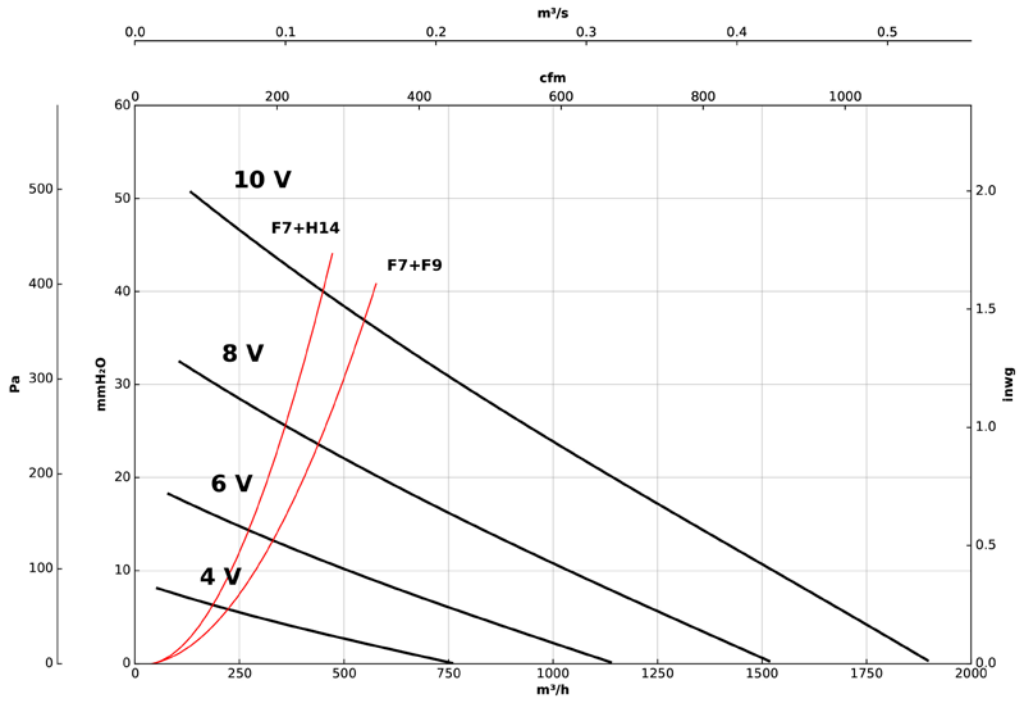

#### CJK/FILTER/EC -400

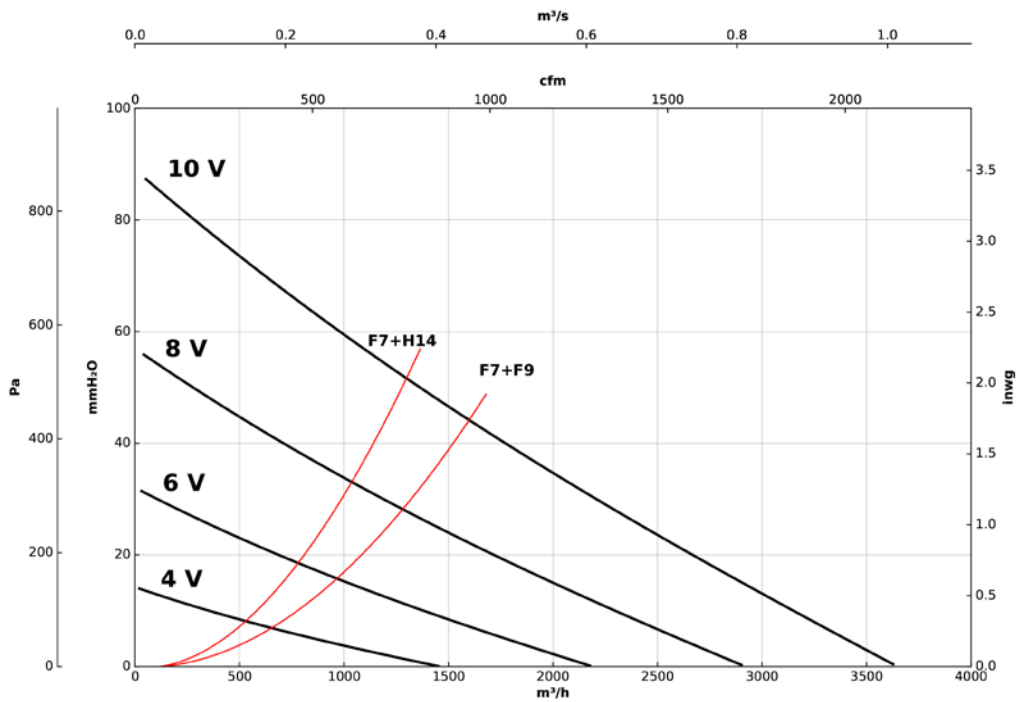

### Characteristic curves

Q= Flow rate in m<sup>3</sup>/h, m<sup>3</sup>/s and cfm

Pe= Static pressure in mm H<sub>2</sub>O, Pa and inwg

#### CJK/FILTER/EC -500

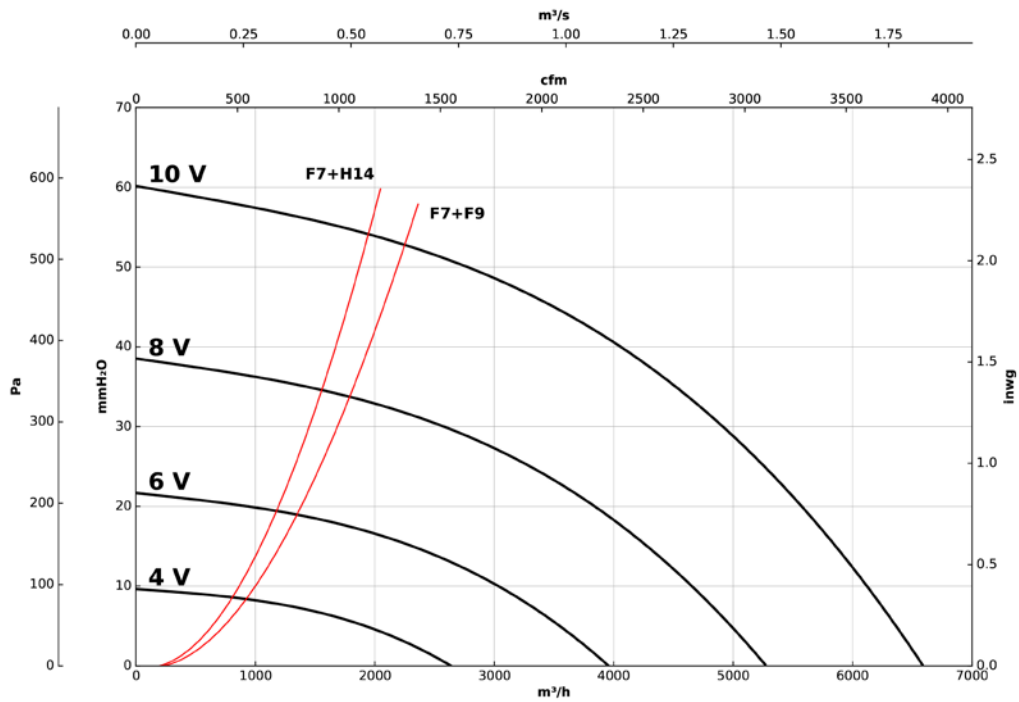

# HC/EC

Wall mounted axial fans, with EC Technology IE5 motor



Wall mounted axial fans with EC Technology IE5 motor with integrated electronics, specially designed for high energy efficiency.

#### Fan:

- Airflow direction from motor to impeller.
- Fibreglass reinforced polyamide-6 impeller.
- Steel sheet support frame.
- Protection grid against contacts according to UNE-EN ISO 12499.
- Models 71, 80, 90 and 100: The protection grid is supplied as an accessory.

#### Motor:

- High efficiency EC Technology motors with integrated electronics, regulated by 0-10 V or 4-20 mA.
- IE5 efficiency motors, class F and IP55 protection.
- Single-phase 230 V 50/60 Hz and three-phase 400 V 50/60 Hz.
- Working temperature: -25 °C +60 °C.

EC CONTROL: Supplied as an optional accessory. Control panel for ventilation

systems with EC Technology motors with the electronics integrated in the motor itself. With the following characteristics:

- CPC: Constant pressure control.
- CFC: Constant flow control.
- DAY/NIGHT: Double pressure setpoint adjustment according to time of day.
- External sensor: compatible with temperature, humidity, air quality or CO sensor.
- Equipment preconfigured in constant pressure mode with 100 Pa set point.

#### Finish:

- Anti-corrosive finish in polyester resin, polymerised at 190 °C, after degreasing with phosphate-free nanotechnology treatment.

#### On request:

- Airflow direction from impeller to motor.
- Motor, impeller and grille assembly (F version), except models 71, 80, 90 and 100, which are supplied without a grille.
- Motor, impeller assembly, version G.



EC TECHNOLOGY MOTOR with integrated electronics



EC CONTROL Supplied as an optional accessory

## Order code

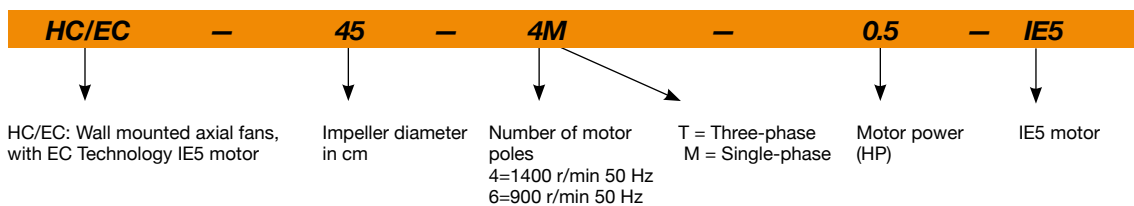

## Technical characteristics

Model	Speed (r/min)	Maximum admissible current (A)		Max. electric power (kW)	Maximum flow rate (m <sup>3</sup> /h)	Sound pressure level dB (A)	Approx. weight (Kg)	According ErP*
		230V	400V					
HC/EC-45-4M-0.5 IE5	1400	3.4		0.37	7300	66	14	2020
HC/EC-50-4M-0.75 IE5	1350	4.8		0.55	10200	69	18	2020
HC/EC-56-4M-1.5 IE5	1455	8.9		1.10	13000	72	28	2020
HC/EC-63-4M-1.5 IE5	1455	8.9		1.10	16450	74	30	2020
HC/EC-71-6M-1 IE5	900	5.9		0.75	17324	65	39	2020
HC/EC-80-4T-3 IE5	1435		5.9	2.20	27856	80	58	2020
HC/EC-90-4T-5.5 IE5	1450		10.6	4.00	43700	86	70	2020
HC/EC-90-6T-2 IE5	950		2.9	1.50	33300	76	64	2020
HC/EC-100-6T-2 IE5	950		2.9	1.50	37000	78	67	2020

\* In accordance with the ErP 2020 draft



## Erp. (Energy Related Products)

Information on Directive 2009/125/EC can be downloaded from the SODECA website or the QuickFan selector programme.

### Acoustic characteristics

The indicated values are determined by measuring the pressure and sound power levels in dB(A) obtained in a free field at a distance equivalent to twice the size of the fan plus the impeller diameter, with a minimum of 1.5 m.

Sound power spectrum Lw(A) in dB(A) per Hz frequency band

	63	125	250	500	1000	2000	4000	8000
HC/EC-45-4M	33	50	63	70	75	76	71	64
HC/EC-50-4M	36	53	66	73	78	79	74	67
HC/EC-56-4M	39	56	69	76	81	82	77	70
HC/EC-63-4M	43	60	73	80	85	86	81	74
HC/EC-71-6M	35	52	65	72	77	78	73	66
HC/EC-80-4T	60	81	88	93	96	92	85	74
HC/EC-90-4T	64	85	92	97	100	96	89	78
HC/EC-90-6T	54	75	82	87	90	86	79	68
HC/EC-100-6T	58	78	86	91	93	90	83	72

### Dimensions mm

HC/EC-45...63

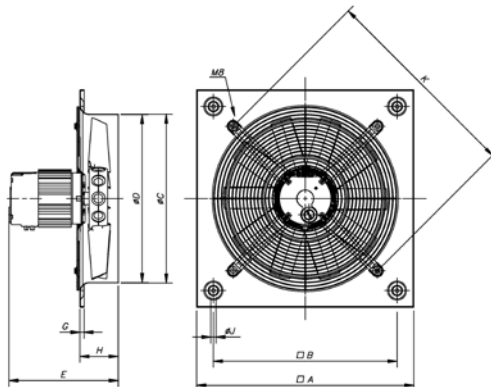

HC/EC-71...100

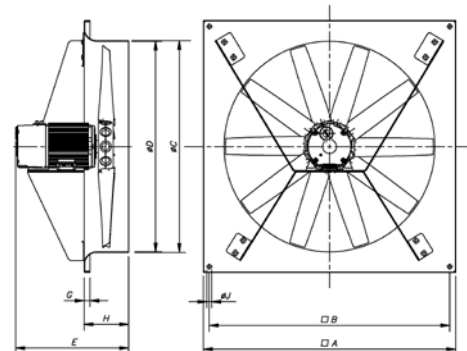

	A	B	ØC	ØD	E	G	H	ØJ	K
HC/EC-45	596	504	462.5	460	322.5	11	105	10.5	560
HC/EC-50	665	562	516.5	514	356.5	11	115	10.5	640
HC/EC-56	710	630	563	560	377.5	15	115	10.5	721
HC/EC-63	800	710	638	635	401	15	140	10.5	820
HC/EC-71	850	810	714	710	405	20	150	14.5	-
HC/EC-80	970	910	804	800	438	20	180	14.5	-
HC/EC-90	1170	1110	904	900	464.5	20	180	14.5	-
HC/EC-100	1170	1110	1004	1000	482	20	180	14.5	-

### Characteristic curves

Q= Flow rate in m<sup>3</sup>/h, m<sup>3</sup>/s and cfm

Pe= Static pressure in mm H<sub>2</sub>O, Pa and inwg

#### HC/EC-45-4M-0.5

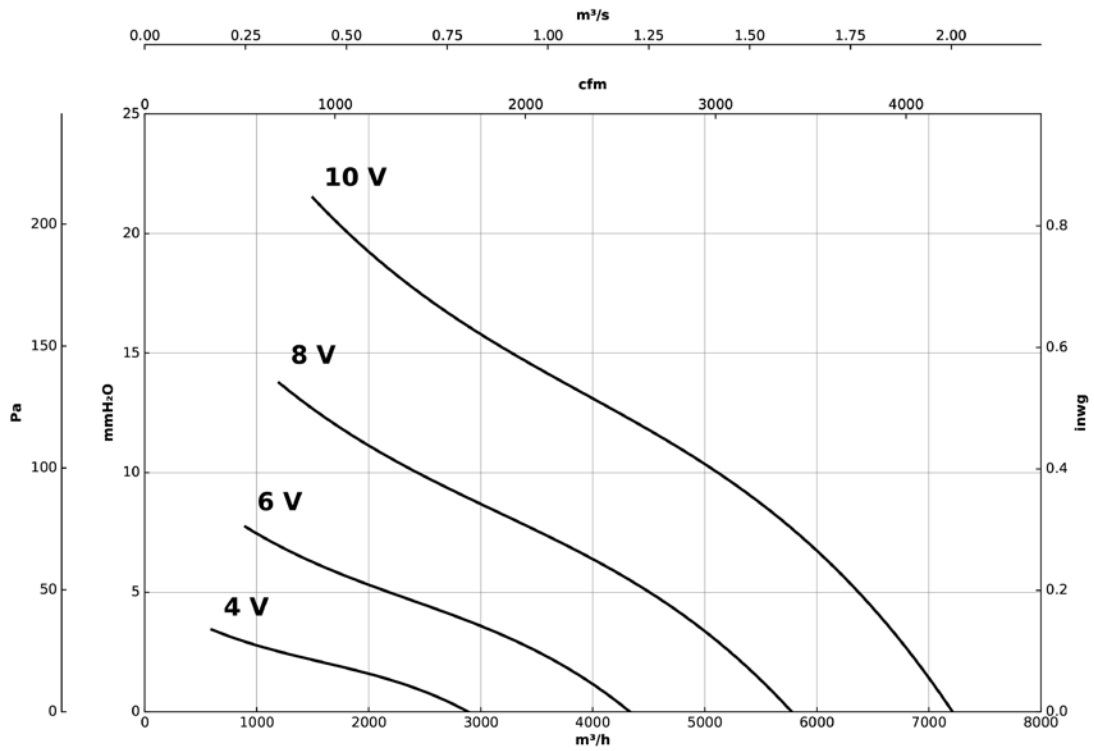

#### HC/EC-50-4M-0.75

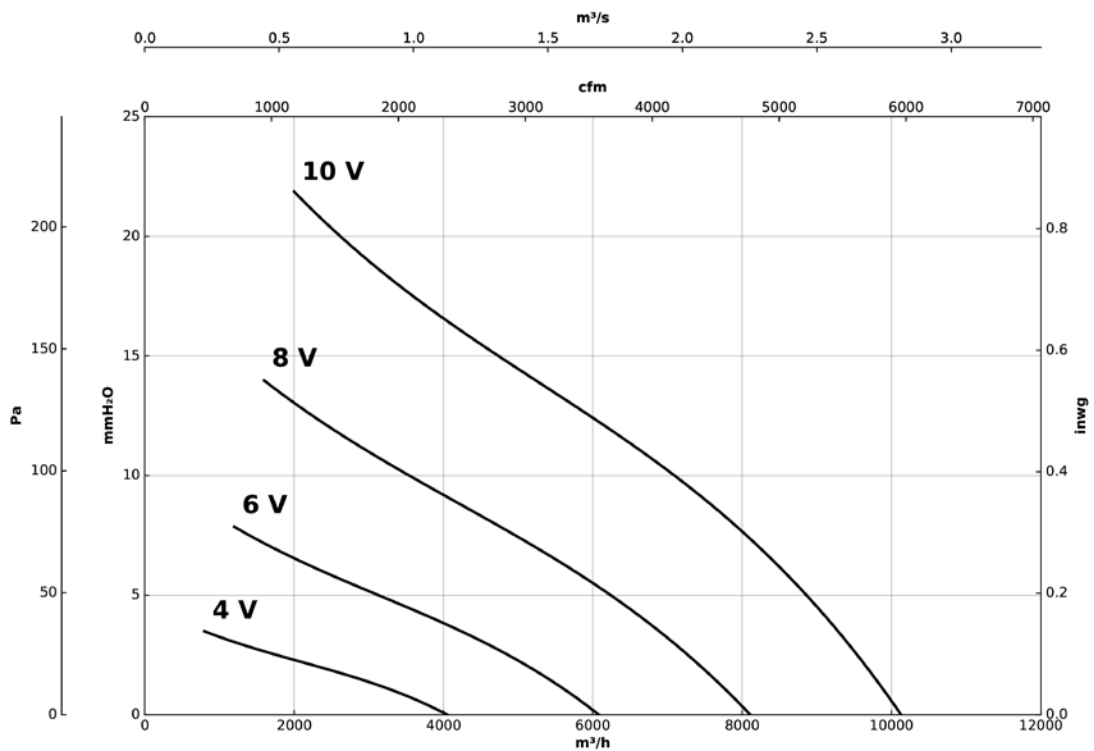



### Characteristic curves

Q= Flow rate in m<sup>3</sup>/h, m<sup>3</sup>/s and cfm

Pe= Static pressure in mm H<sub>2</sub>O, Pa and inwg

#### HC/EC-56-4M-1.5

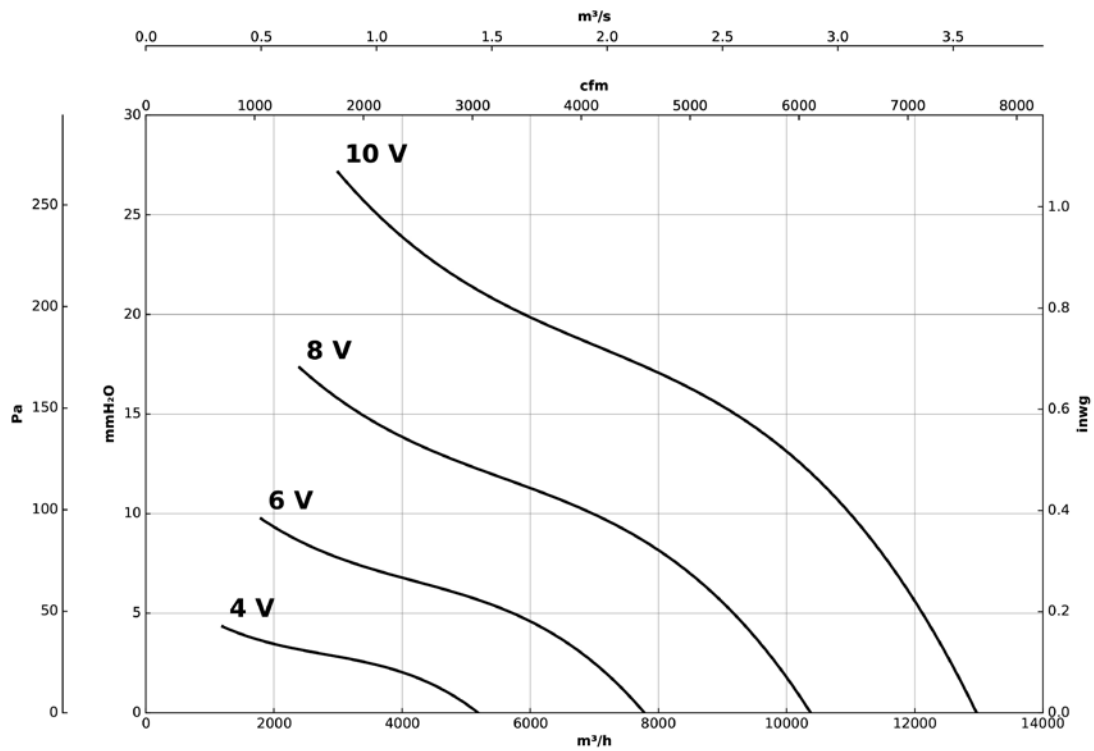

#### HC/EC-63-4M-1.5

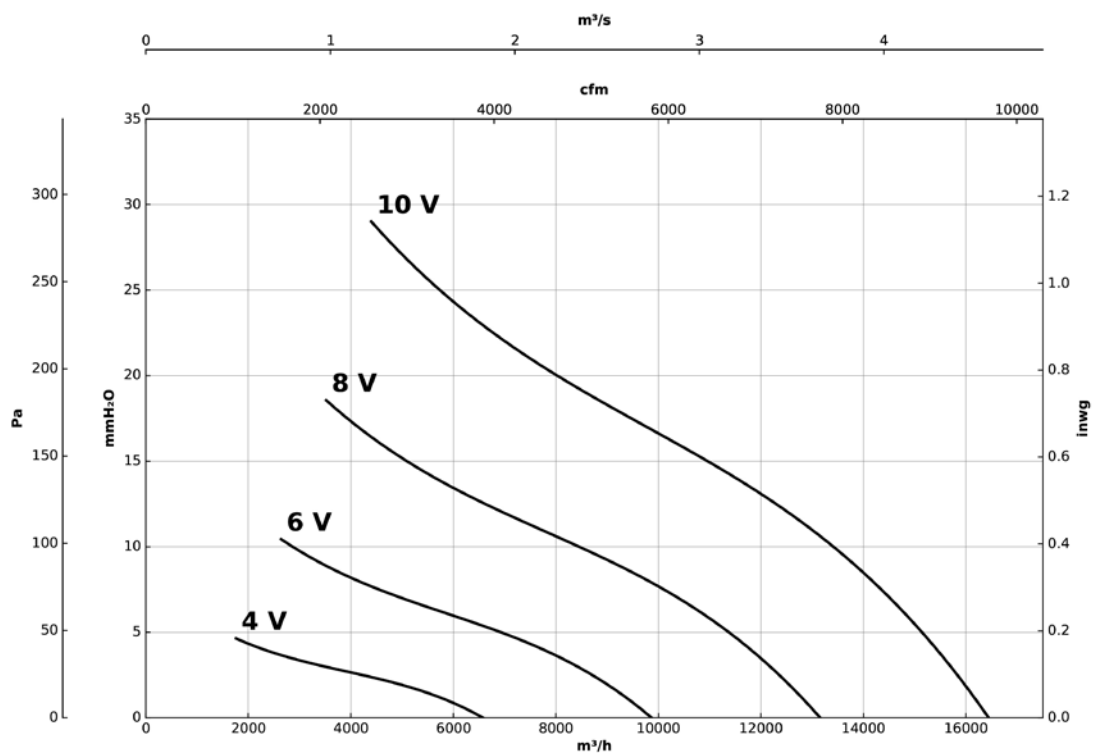

### Characteristic curves

Q= Flow rate in m<sup>3</sup>/h, m<sup>3</sup>/s and cfm

Pe= Static pressure in mm H<sub>2</sub>O, Pa and inwg

#### HC/EC-71-6M-1

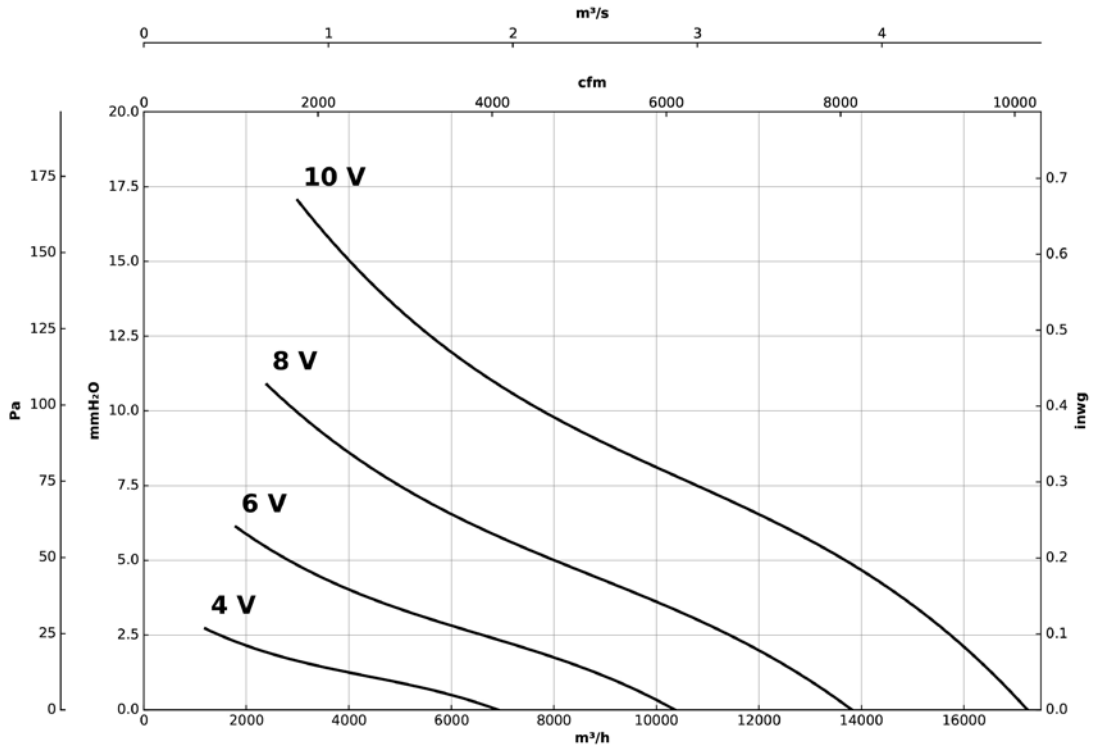

#### HC/EC-80-4T-3

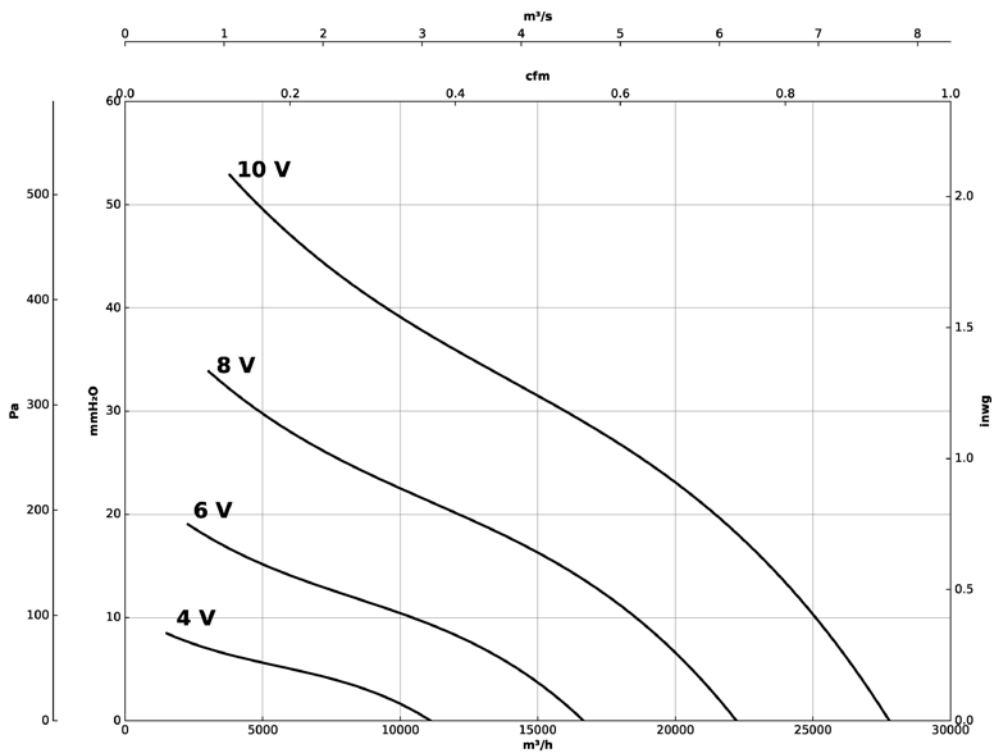

### Characteristic curves

Q= Flow rate in m<sup>3</sup>/h, m<sup>3</sup>/s and cfm

Pe= Static pressure in mm H<sub>2</sub>O, Pa and inwg

#### HC/EC-90-4T-5.5

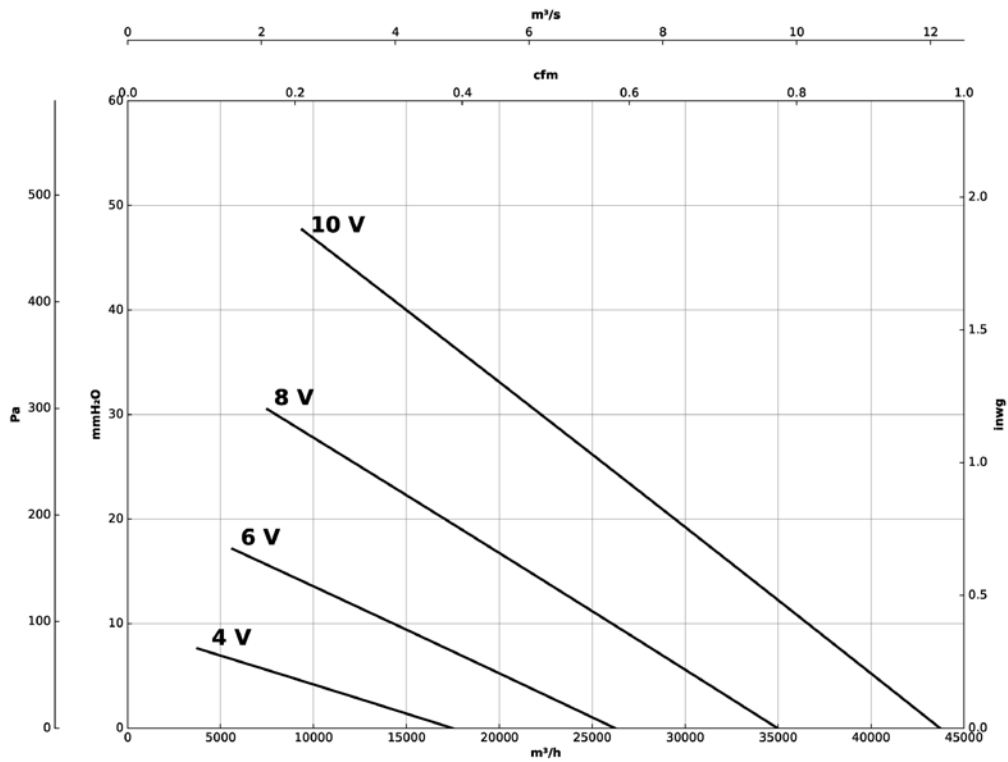

#### HC/EC-90-6T-2

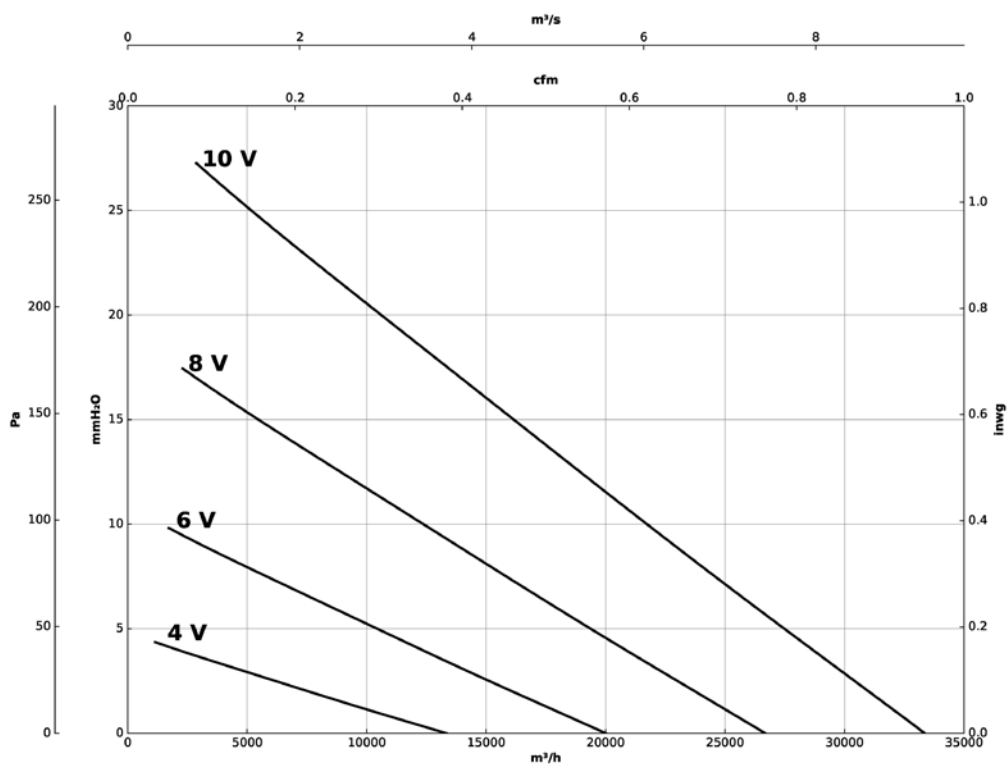

## Characteristic curves

Q= Flow rate in m<sup>3</sup>/h, m<sup>3</sup>/s and cfm

Pe= Static pressure in mm H<sub>2</sub>O, Pa and inwg

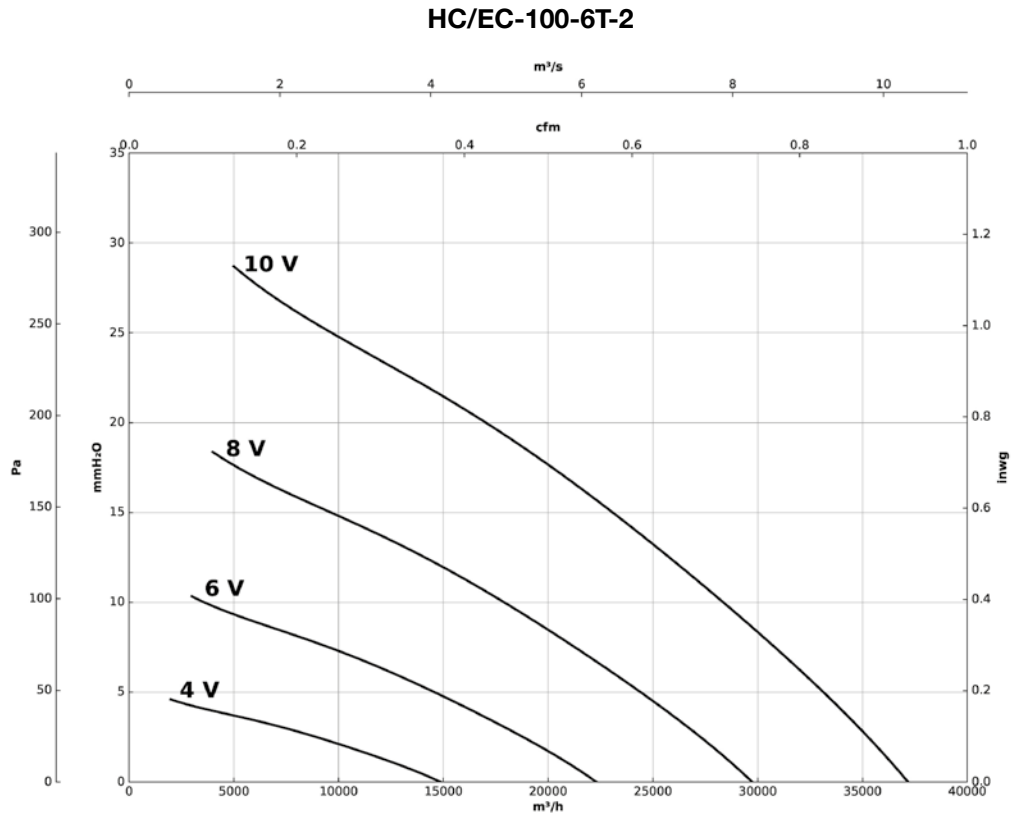

## Accessories



# HCT/EC

Tubular axial fans, with EC Technology IE5 motor



← EC TECHNOLOGY MOTOR with integrated electronics



← EC CONTROL Supplied as an optional accessory

Tubular axial fans with EC Technology IE5 motor with integrated electronics, specially designed for high energy efficiency.

**Fan:**

- Airflow direction from motor to impeller.
- Fibreglass reinforced polyamide-6 impeller. AL version made of cast aluminium.
- Long tubular casing in sheet steel with external terminal box.

**Motor:**

- High efficiency EC Technology motors with integrated electronics, regulated by 0-10 V or 4-20 mA.
- IE5 efficiency motors, class F and IP55 protection.
- Single-phase 230 V 50/60 Hz and three-phase 400 V 50/60 Hz.
- Working temperature: -25 °C +60 °C.

EC CONTROL: Supplied as an optional accessory. Control panel for ventilation

systems with EC Technology motors with the electronics integrated in the motor itself. With the following characteristics:

- CPC: Constant pressure control.
- CFC: Constant flow control.
- DAY/NIGHT: Double pressure setpoint adjustment according to time of day.
- External sensor: compatible with temperature, humidity, air quality or CO sensor.
- Equipment preconfigured in constant pressure mode with 100 Pa set point.

**Finish:**

- Anti-corrosive finish in polyester resin, polymerised at 190 °C, after degreasing with phosphate-free nanotechnology treatment.

**On request:**

- Airflow direction from impeller to motor.
- 100% reversible impellers.

## Order code

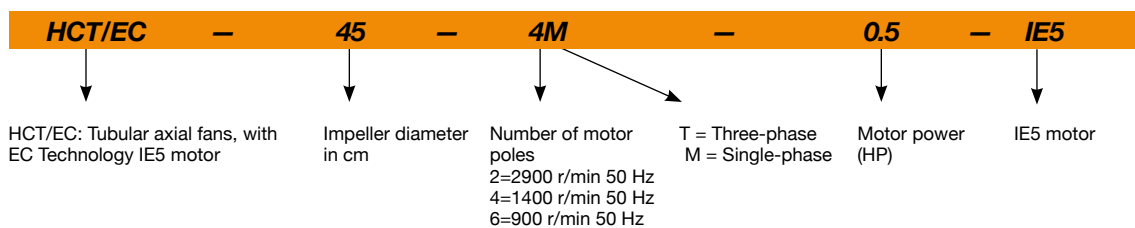

## Technical characteristics

Model	Speed (r/min)	Maximum admissible current (A)		Max. electric power (kW)	Maximum flow rate (m³/h)	Sound pressure level dB (A)	Approx. weight (Kg)	According ErP*
		230V	400V					
HCT/EC-45-2T-3 IE5	2910		6.1	2.20	12750	88	39	2020
HCT/EC-45-4M-0.5 IE5	1400	3.4		0.37	7100	68	24	2020
HCT/EC-50-4M-0.75 IE5	1350	4.8		0.55	10400	70	28	2020
HCT/EC-56-4M-1.5 IE5	1455	8.9		1.10	14000	74	40	2020
HCT/EC-63-4M-1.5 IE5	1455	8.9		1.10	17000	74	49	2020
HCT/EC-63-4T-3 IE5	1435		5.9	2.20	22100	76	58	2020
HCT/EC-71-4T-3 IE5	1435		5.9	2.20	23950	81	65	2020
HCT/EC-71-6M-1 IE5	940	5.9		0.75	17250	68	58	2020
HCT/EC-80-4T-3 IE5	1435		5.9	2.20	28000	82	73	2020
HCT/EC-80-4T-5.5 IE5	1450		10.6	4.00	37200	84	81	2020
HCT/EC-90-4T-5.5 IE5	1450		10.6	4.00	41850	89	97	2020
HCT/EC-90-6T-3 IE5	950		7.5	2.20	35000	78	96	2020
HCT/EC-100-6T-3 IE5	950		7.5	2.20	40500	82	107	2020

\* In accordance with the ErP 2020 draft



## Erp. (Energy Related Products)

Information on Directive 2009/125/EC can be downloaded from the SODECA website or the QuickFan selector programme.

### Acoustic characteristics

The indicated values are determined by measuring the pressure and sound power levels in dB(A) obtained in a free field at a distance equivalent to twice the size of the fan plus the impeller diameter, with a minimum of 1.5 m.

Sound power spectrum Lw(A) in dB(A) per Hz frequency band

	63	125	250	500	1000	2000	4000	8000
HCT/EC-45-2T-3	53	70	82	90	95	95	91	84
HCT/EC-45-4M-0.5	33	50	62	70	75	75	71	64
HCT/EC-50-4M-0.75	37	54	67	74	79	80	75	68
HCT/EC-56-4M-1.5	49	69	77	82	84	81	74	63
HCT/EC-63-4M-1.5	51	71	79	84	86	83	76	65
HCT/EC-63-4T-3	53	73	81	86	88	85	78	67
HCT/EC-71-4T-3	58	78	86	91	93	90	83	72
HCT/EC-71-6M-1	45	65	73	78	80	77	70	59
HCT/EC-80-4T-3	59	79	87	92	94	91	84	73
HCT/EC-80-4T-5.5	61	81	89	94	96	93	86	75
HCT/EC-90-4T-5.5	67	88	95	100	103	99	92	81
HCT/EC-90-6T-3	56	77	84	89	92	88	81	70
HCT/EC-100-6T-3	62	82	90	95	97	94	87	76

### Dimensions mm

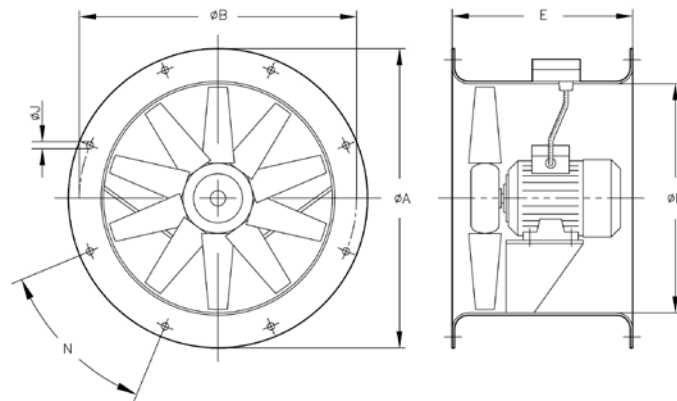

	ØA	ØB	ØD	E	ØJ	N
HCT/EC-45	540	500	460	360	12	8x45°
HCT/EC-50	600	560	514	360	12	12x30°
HCT/EC-56	660	620	560	400	12	12x30°
HCT/EC-63	730	690	640	430	12	12x30°
HCT/EC-71	810	770	710	500	12	16x22°30'
HCT/EC-80	900	860	800	500	12	16x22°30'
HCT/EC-90	1015	970	900	500	15	16x22°30'
HCT/EC-100	1115	1070	1000	600	15	16x22°30'

### Characteristic curves

Q= Flow rate in m<sup>3</sup>/h, m<sup>3</sup>/s and cfm

Pe= Static pressure in mm H<sub>2</sub>O, Pa and inwg

#### HCT/EC-45-2T-3

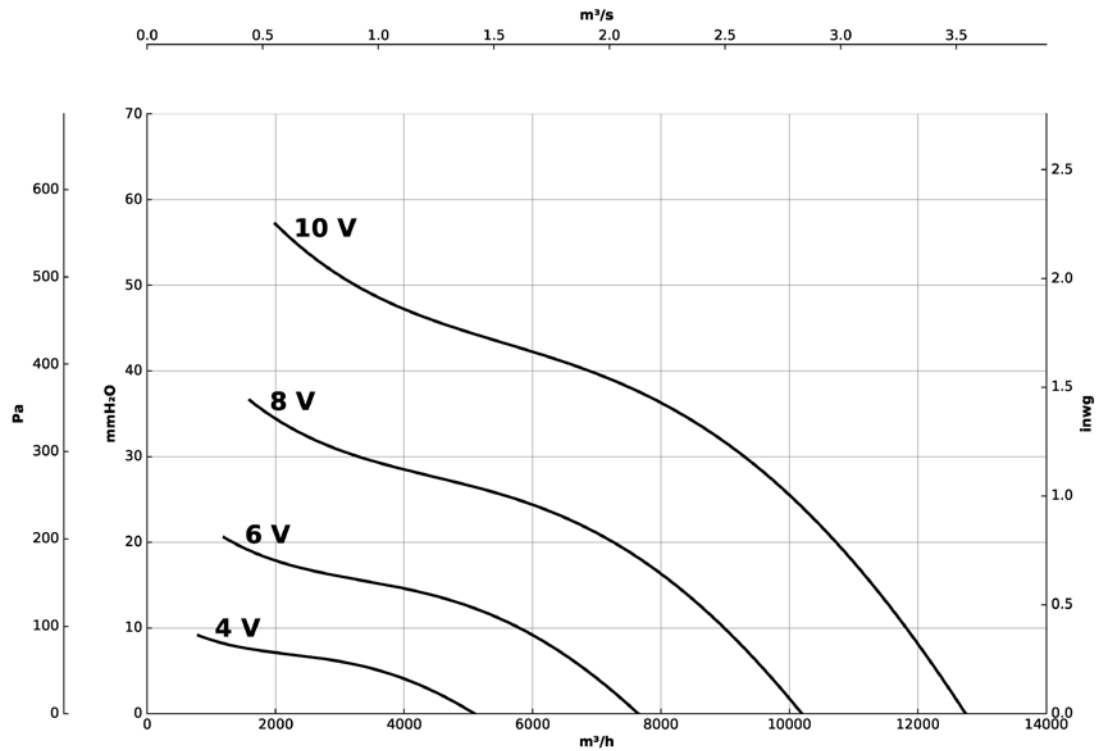

#### HCT/EC-45-4M-0.5

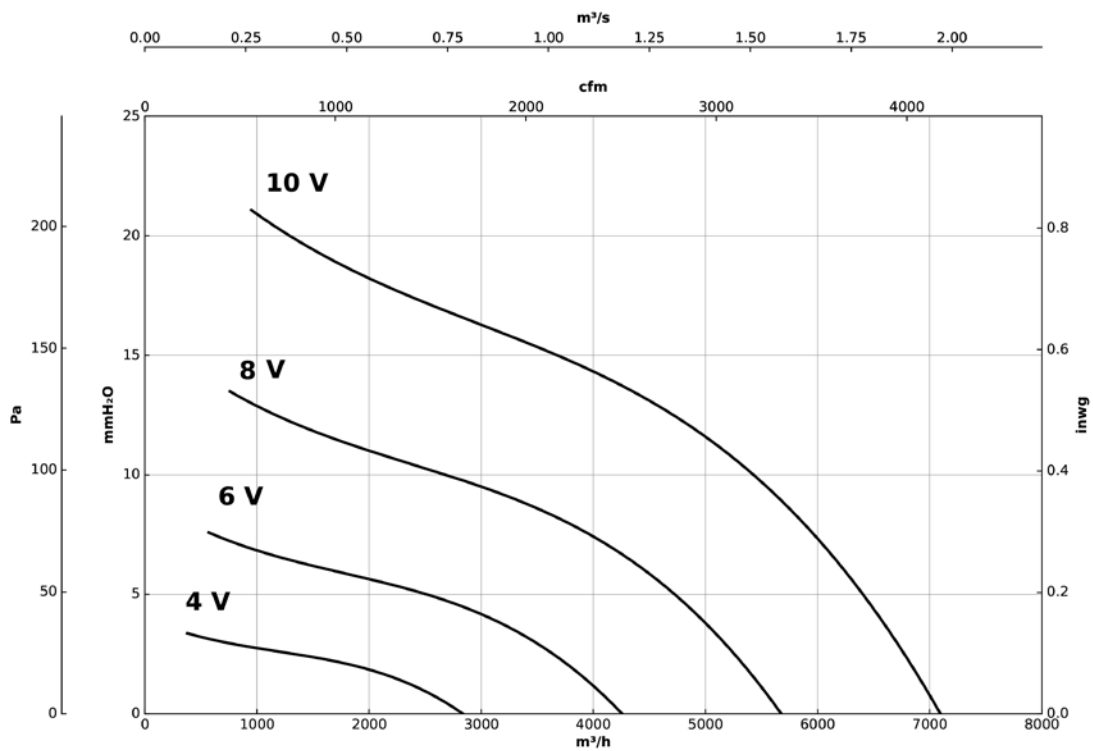

### Characteristic curves

Q= Flow rate in m<sup>3</sup>/h, m<sup>3</sup>/s and cfm

Pe= Static pressure in mm H<sub>2</sub>O, Pa and inwg

#### HCT/EC-50-4M-0.75

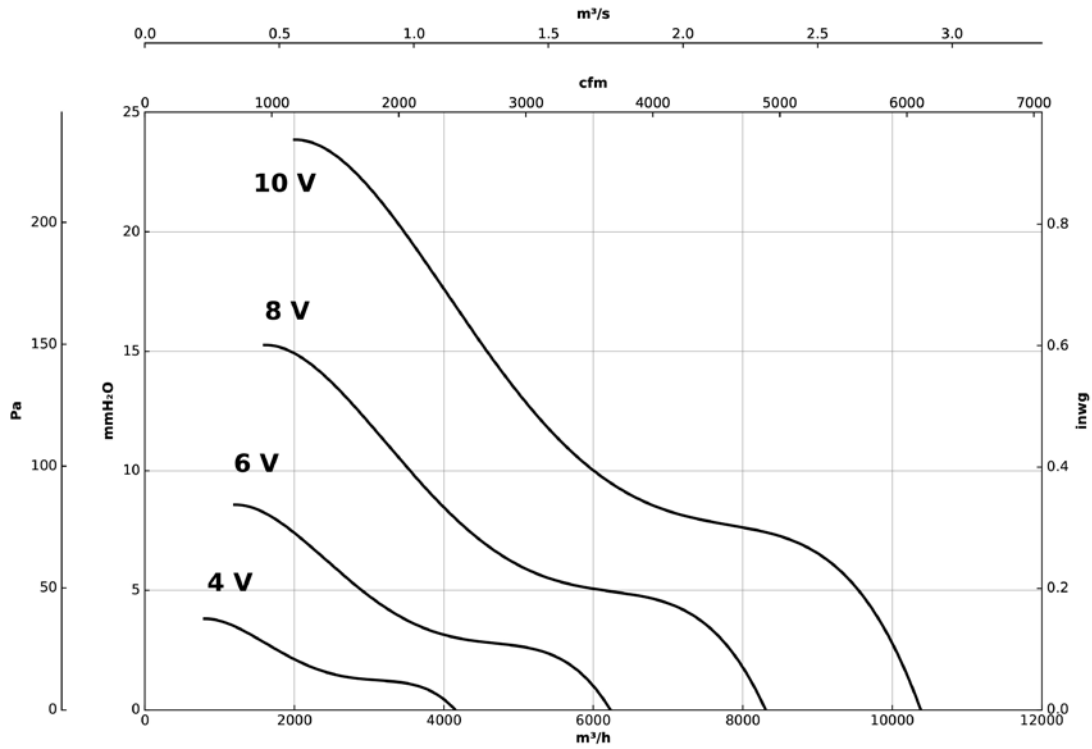

#### HCT/EC-56-4M-1.5

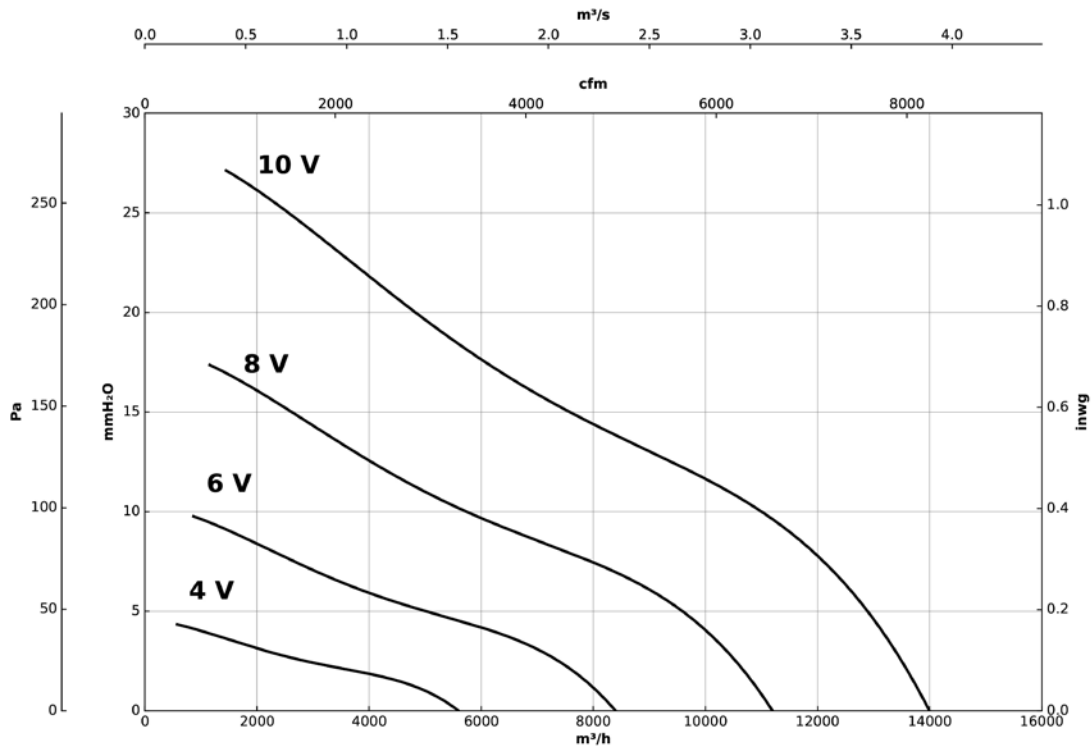



### Characteristic curves

Q= Flow rate in m<sup>3</sup>/h, m<sup>3</sup>/s and cfm

Pe= Static pressure in mm H<sub>2</sub>O, Pa and inwg

#### HCT/EC-63-4M-1.5

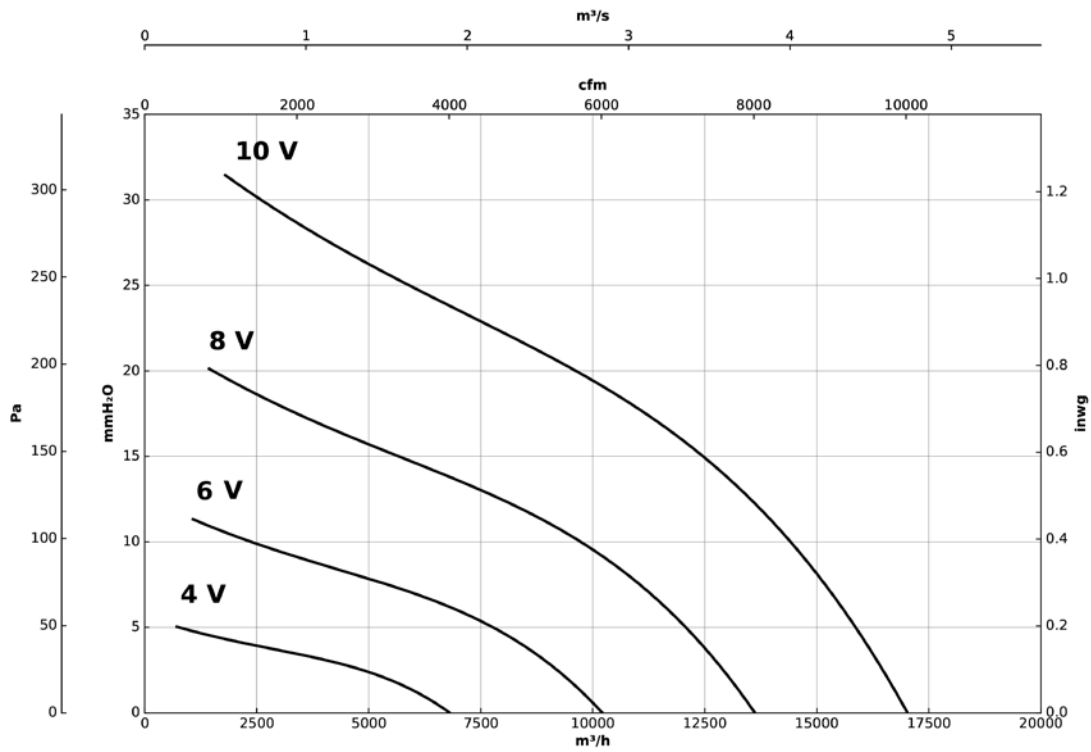

#### HCT/EC-63-4T-3

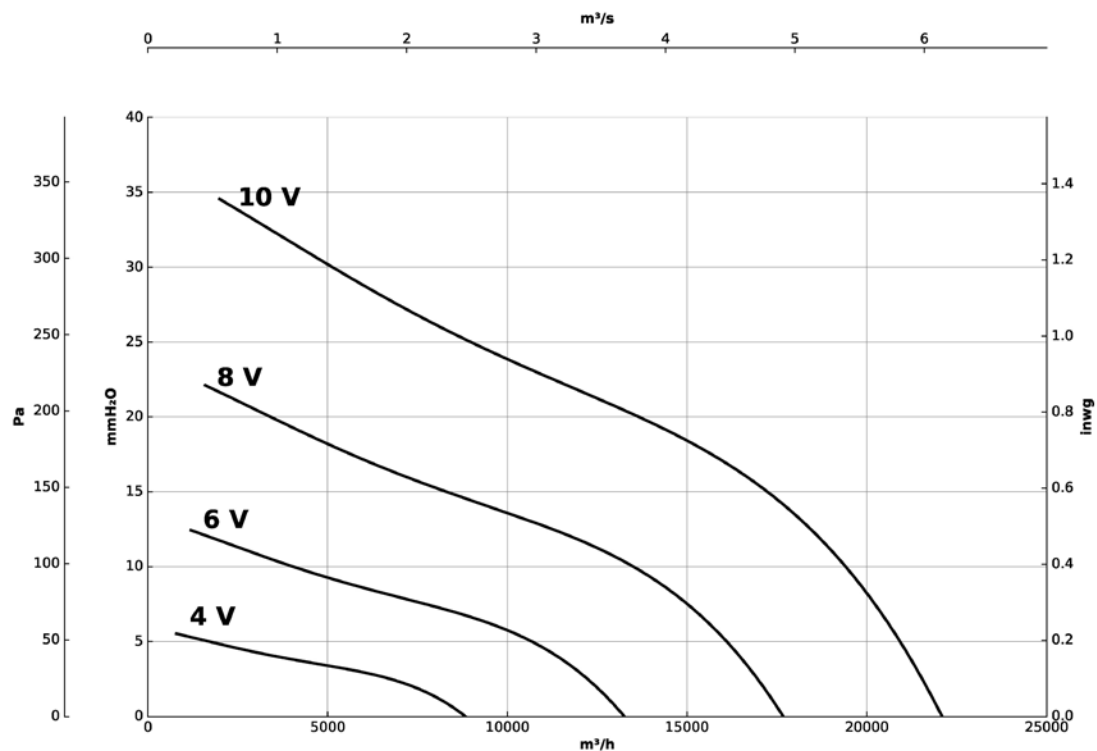

### Characteristic curves

Q= Flow rate in m<sup>3</sup>/h, m<sup>3</sup>/s and cfm

Pe= Static pressure in mm H<sub>2</sub>O, Pa and inwg

#### HCT/EC-71-4T-3

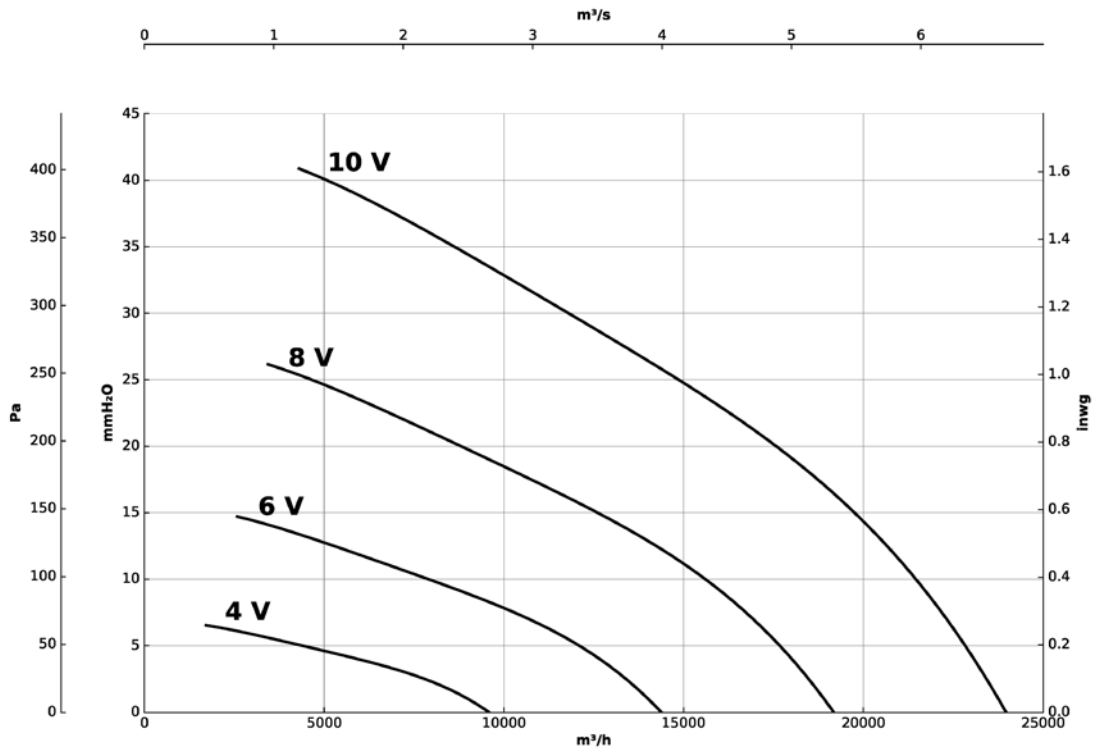

#### HCT/EC-71-6M-1

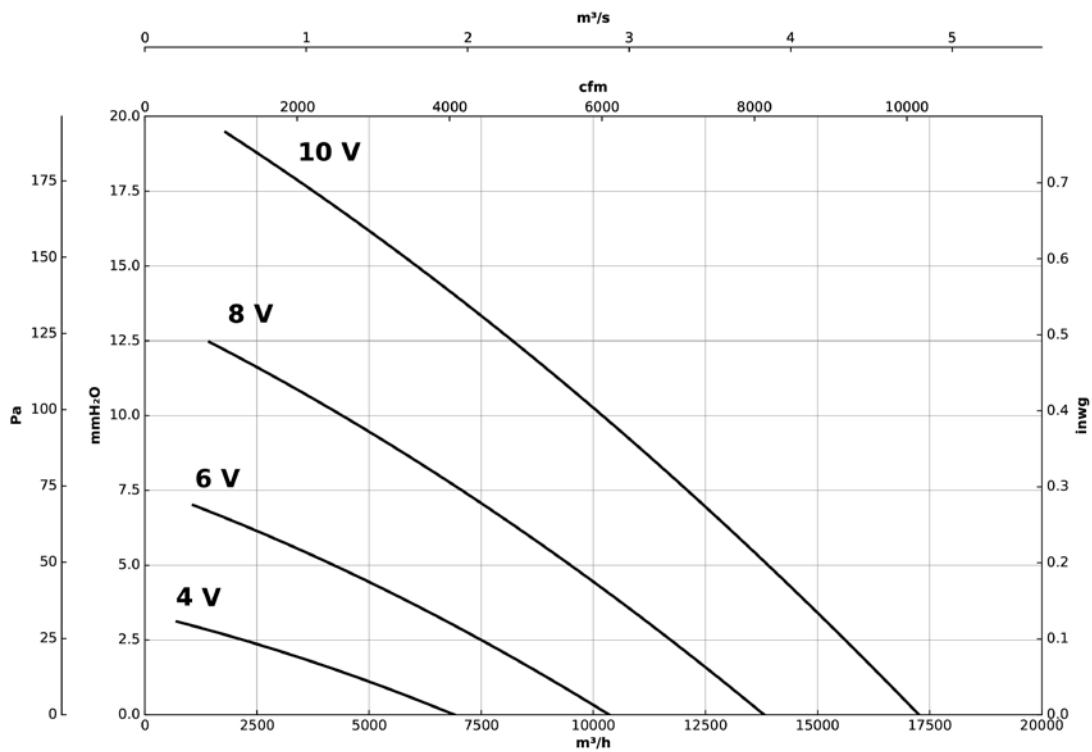

### Characteristic curves

Q= Flow rate in m<sup>3</sup>/h, m<sup>3</sup>/s and cfm

Pe= Static pressure in mm H<sub>2</sub>O, Pa and inwg

#### HCT/EC-80-4T-3

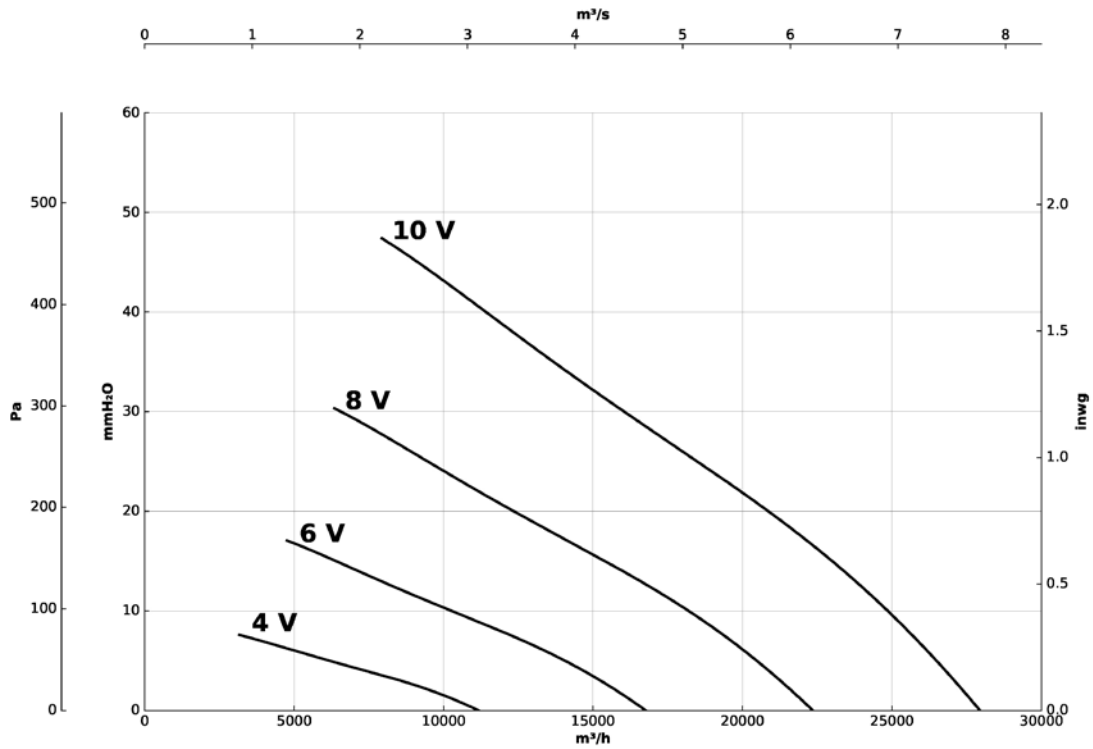

#### HCT/EC-80-4T-5.5

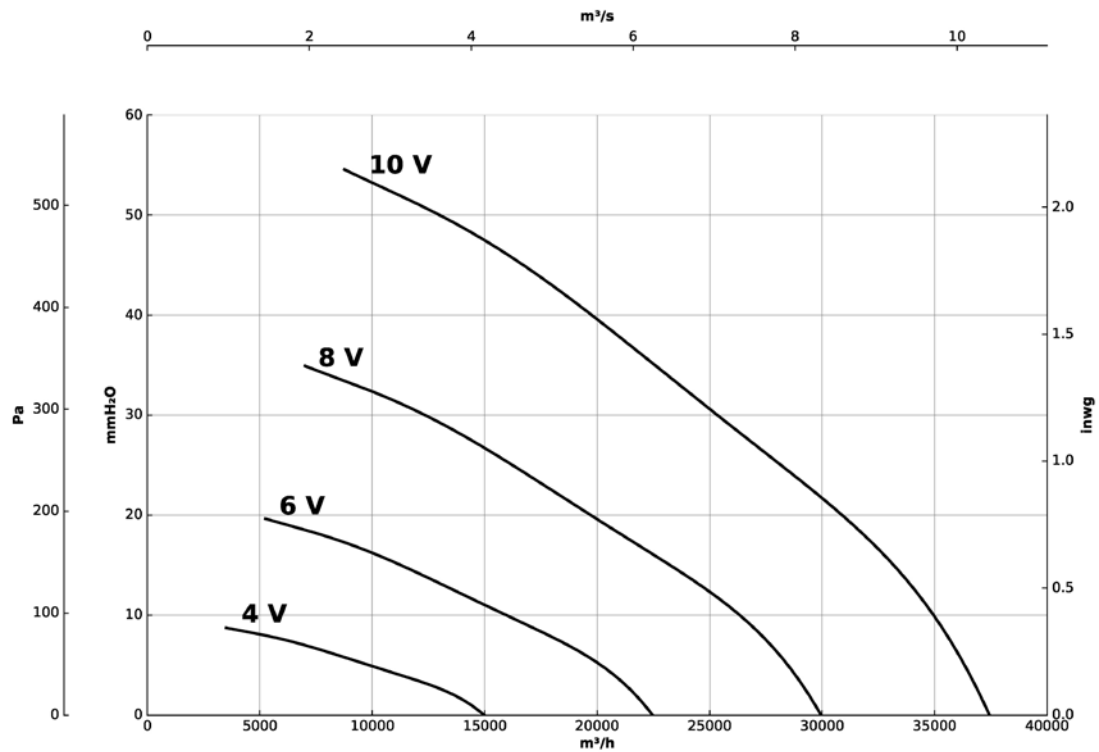

### Characteristic curves

Q= Flow rate in m<sup>3</sup>/h, m<sup>3</sup>/s and cfm

Pe= Static pressure in mm H<sub>2</sub>O, Pa and inwg

#### HCT/EC-90-4T-5.5

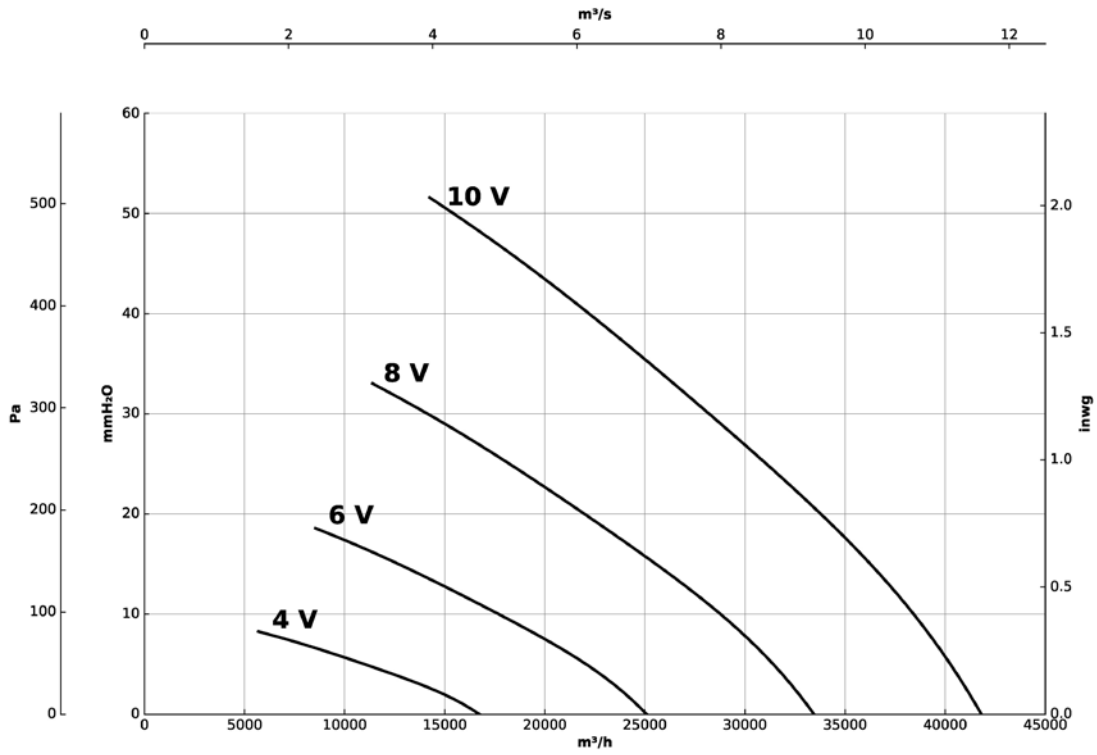

#### HCT/EC-90-6T-3

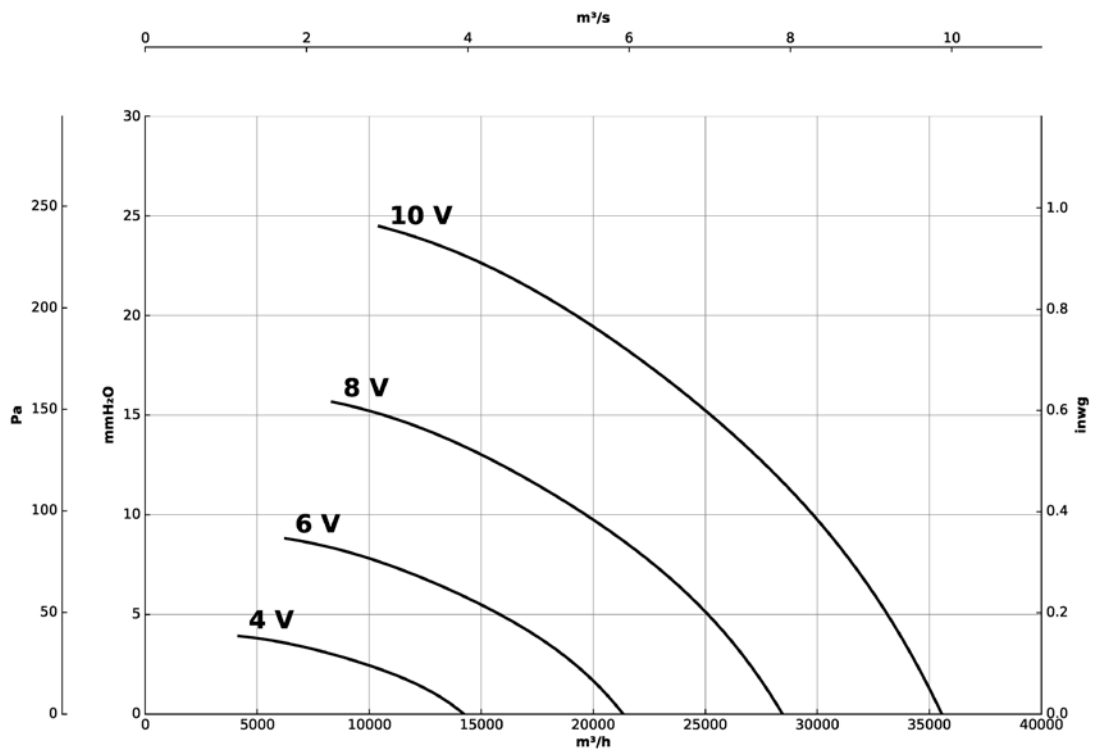

### Characteristic curves

Q= Flow rate in m<sup>3</sup>/h, m<sup>3</sup>/s and cfm

Pe= Static pressure in mm H<sub>2</sub>O, Pa and inwg

#### HCT/EC-100-6T-3

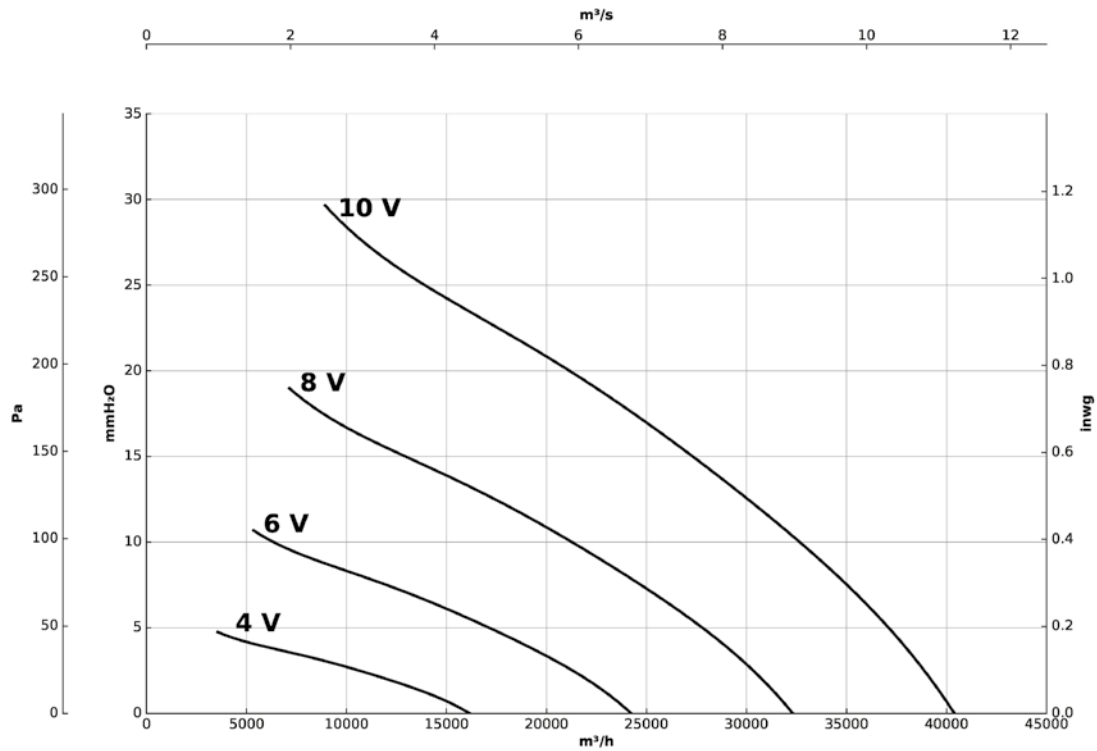

### Accessories



# HFW/EC

Hot dip galvanized tubular axial fans, with EC Technology IE5 motor



Hot-dip galvanized tubular axial fans, with EC Technology IE5 motor with integrated electronics, specially designed for high energy efficiency.

**Fan:**

- Airflow direction from motor to impeller.
- AL version rotors made of cast aluminium.
- Support ring in sheet steel with double flange and cable glands for motor supply.
- Hot dip galvanised tubular sheet steel casing.

**EC CONTROL:** Supplied as an optional accessory. Control panel for ventilation systems with EC Technology motors with the electronics integrated in the motor itself. With the following characteristics:

- CPC: Constant pressure control.
- CFC: Constant flow control.
- DAY/NIGHT: Double pressure setpoint adjustment according to time of day.
- External sensor: compatible with temperature, humidity, air quality or CO sensor.
- Equipment preconfigured in constant pressure mode with 100 Pa set point.



← EC TECHNOLOGY MOTOR with integrated electronics



← EC CONTROL Supplied as an optional accessory

**Motor:**

- High efficiency EC Technology motors with integrated electronics, regulated by 0-10 V or 4-20 mA.
- IE5 efficiency motors, class F and IP55 protection.
- Single-phase 230 V 50/60 Hz and three-phase 400 V 50/60 Hz.
- Working temperature: -25 °C +60 °C.

**Finish:**

- Hot dip galvanized

**On request:**

- Airflow direction from impeller to motor.
- Fibreglass reinforced polyamide PL version impellers.
- 100% reversible impellers.

## Order code

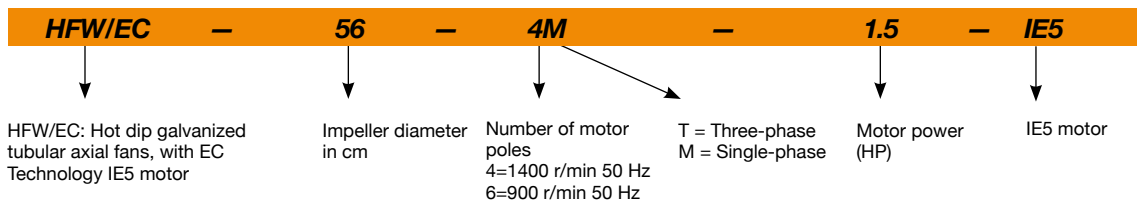

## Technical characteristics

Model	Speed (r/min)	Maximum admissible current (A)		Max. electric power (kW)	Maximum flow rate (m³/h)	Sound pressure level dB (A)	Approx. weight (Kg)	According ErP*
		230V	400V					
HFW/EC-56-4M-1.5 IE5	1455	8.9		1.1	13600	74	34	2020
HFW/EC-63-4M-1.5 IE5	1455	8.9		1.1	17800	74	36	2020
HFW/EC-63-4T-3 IE5	1435		5.9	2.2	22150	76	44	2020
HFW/EC-71-4M-1.5 IE5	1455	8.9		1.1	19500	78	39	2020
HFW/EC-71-4T-3 IE5	1435		5.9	2.2	25100	81	48	2020
HFW/EC-80-4T-3 IE5	1435		5.9	2.2	25450	82	56	2020
HFW/EC-80-4T-5.5 IE5	1450		10.6	4.0	32750	84	64	2020
HFW/EC-80-6T-3 IE5	950		7.5	2.2	29950	74	63	2020
HFW/EC-90-4T-5.5 IE5	1450		10.6	4.0	38900	89	73	2020
HFW/EC-90-6T-2 IE5	950		2.9	1.5	28800	77	67	2020
HFW/EC-90-6T-3 IE5	950		7.5	2.2	34000	78	72	2020
HFW/EC-100-6T-3 IE5	950		7.5	2.2	37600	82	80	2020

\* In accordance with the ErP 2020 draft



## Erp. (Energy Related Products)

Information on Directive 2009/125/EC can be downloaded from the SODECA website or the QuickFan selector programme.

### Acoustic characteristics

The indicated values are determined by measuring the pressure and sound power levels in dB(A) obtained in a free field at a distance equivalent to twice the size of the fan plus the impeller diameter, with a minimum of 1.5 m.

Sound power spectrum Lw(A) in dB(A) per Hz frequency band

	63	125	250	500	1000	2000	4000	8000
HFW/EC-56-4M-1.5	49	69	77	82	84	81	74	63
HFW/EC-63-4M-1.5	48	68	76	81	83	80	73	65
HFW/EC-63-4T-3	53	70	78	83	85	82	77	67
HFW/EC-71-4M-1.5	54	74	82	87	89	86	79	69
HFW/EC-71-4T-3	58	72	80	85	87	84	77	71
HFW/EC-80-4T-3	57	77	85	90	92	89	82	73
HFW/EC-80-4T-5.5	56	75	84	89	91	88	81	70
HFW/EC-80-6T-3	51	68	76	81	83	80	73	62
HFW/EC-90-4T-5.5	60	81	88	93	96	92	85	74
HFW/EC-90-6T-2	58	79	86	91	94	90	83	72
HFW/EC-90-6T-3	56	70	77	82	85	81	74	63
HFW/EC-100-6T-3	61	72	80	85	87	84	77	66

### Dimensions mm

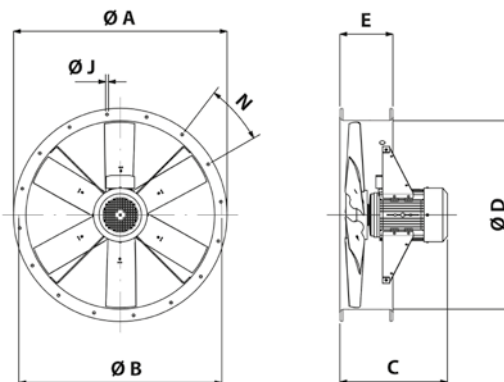

	ØA	ØB	C	ØD	E	N	ØJ
HFW/EC-56-4M-1.5	666	620	377	560	225	12X30°	12
HFW/EC-63-4M-1.5	735	690	389	640	225	12X30°	12
HFW/EC-63-4T-3	735	690	428	640	225	12X30°	12
HFW/EC-71-4M-1.5	815	770	360	710	225	12X30°	12
HFW/EC-71-4T-3	815	770	428	710	225	16x22°30'	12
HFW/EC-80-4T-3	905	860	436	800	225	16x22°30'	12
HFW/EC-80-4T-5.5	905	860	436	800	225	16x22°30'	12
HFW/EC-80-6T-3	905	860	436	800	225	16x22°30'	12
HFW/EC-90-4T-5.5	1020	970	445	900	225	16x22°30'	15
HFW/EC-90-6T-2	1020	970	445	900	225	16x22°30'	15
HFW/EC-90-6T-3	1020	970	445	900	225	16x22°30'	15
HFW/EC-100-6T-3	1118	1070	427	1000	225	16x22°30'	15

### Accessories

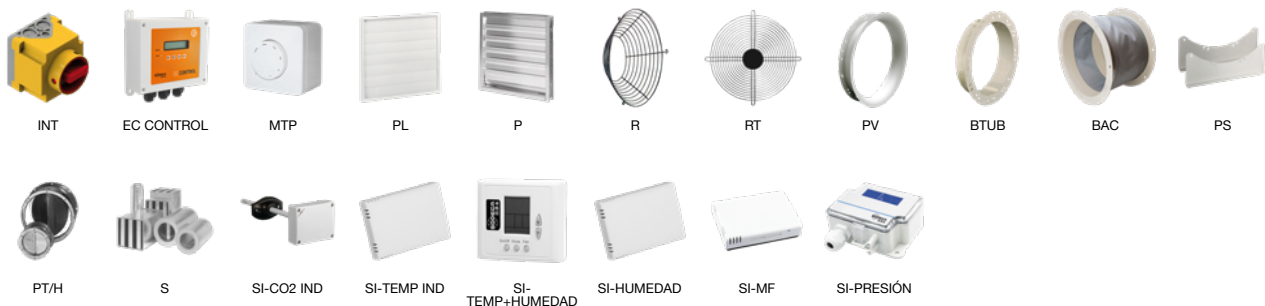

### Characteristic curves

Q= Flow rate in m<sup>3</sup>/h, m<sup>3</sup>/s and cfm

Pe= Static pressure in mm H<sub>2</sub>O, Pa and inwg

**HFW/EC-56-4M-1.5**

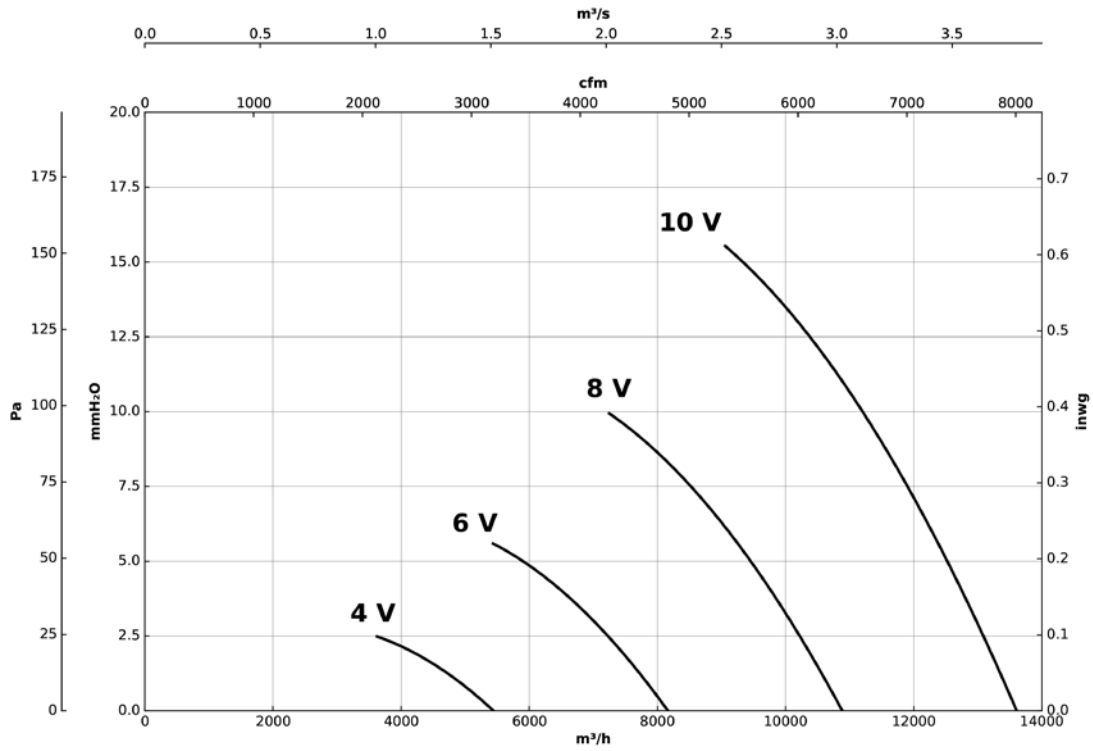

**HFW/EC-63-4M-1.5**

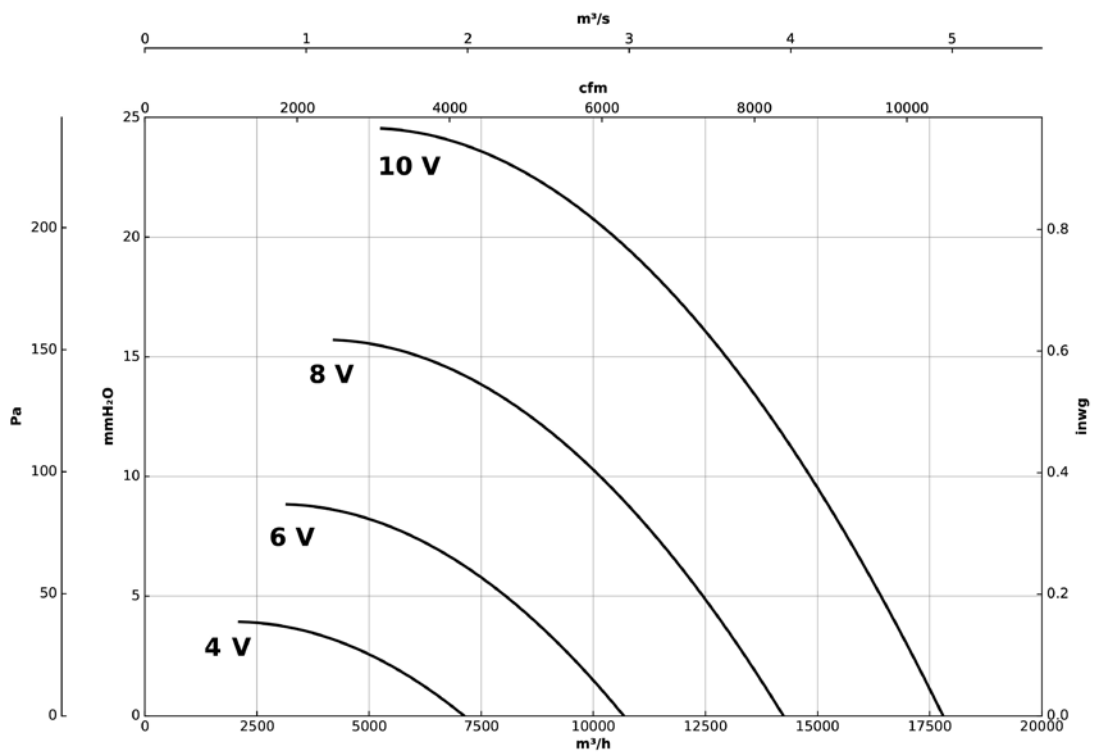



### Characteristic curves

Q= Flow rate in m<sup>3</sup>/h, m<sup>3</sup>/s and cfm

Pe= Static pressure in mm H<sub>2</sub>O, Pa and inwg

**HFW/EC-63-4T-3**

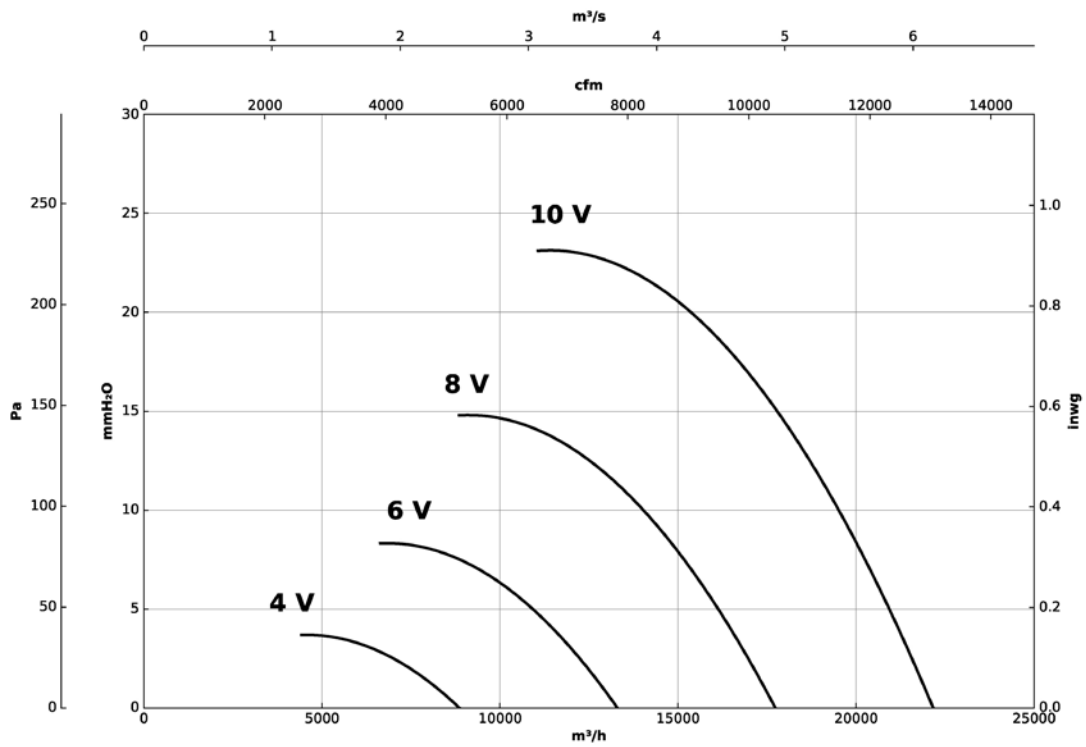

**HFW/EC-71-4M-1.5**

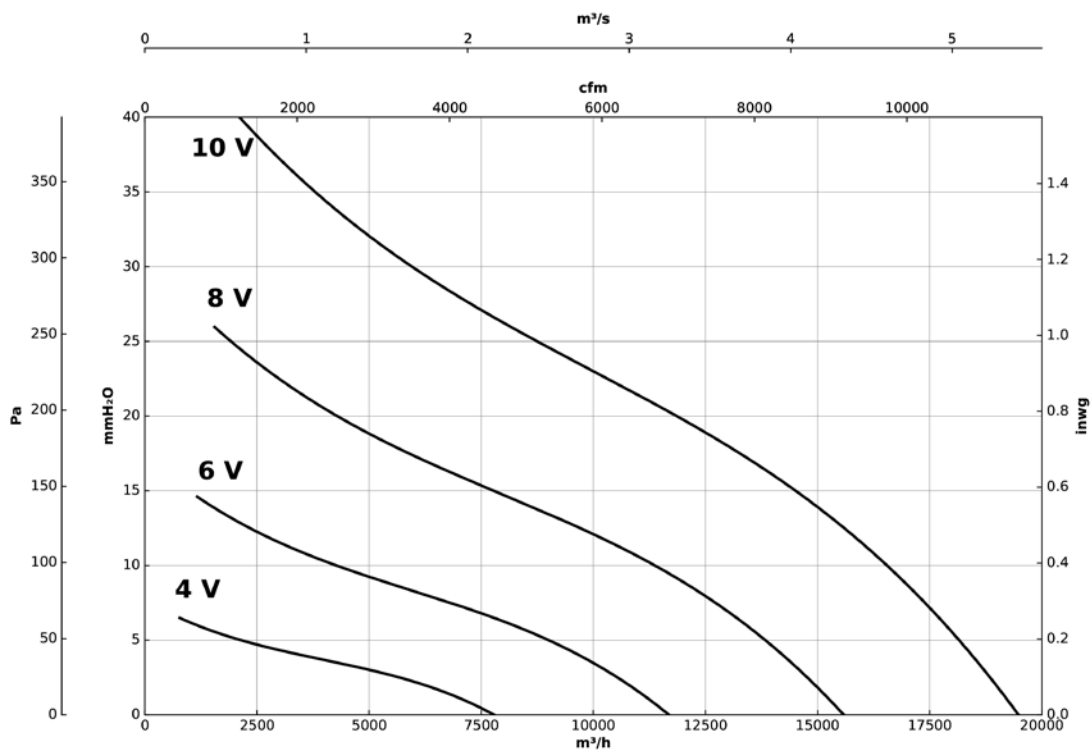

### Characteristic curves

Q= Flow rate in m<sup>3</sup>/h, m<sup>3</sup>/s and cfm

Pe= Static pressure in mm H<sub>2</sub>O, Pa and inwg

**HFW/EC-71-4T-3**

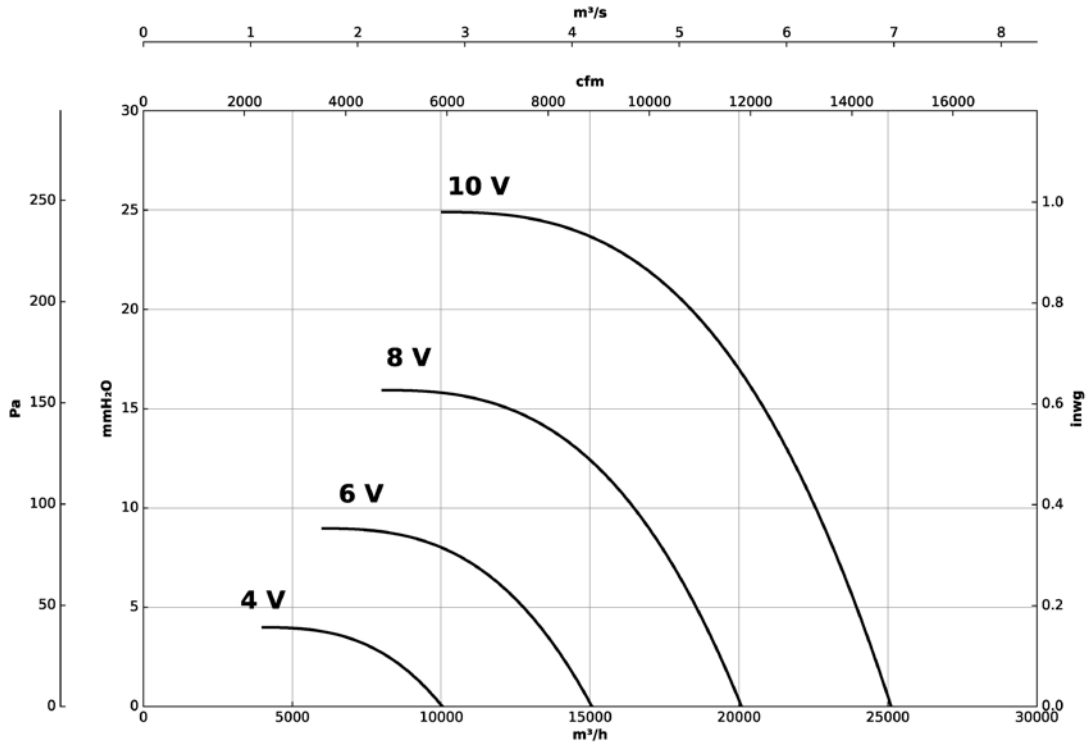

**HFW/EC-80-4T-3**

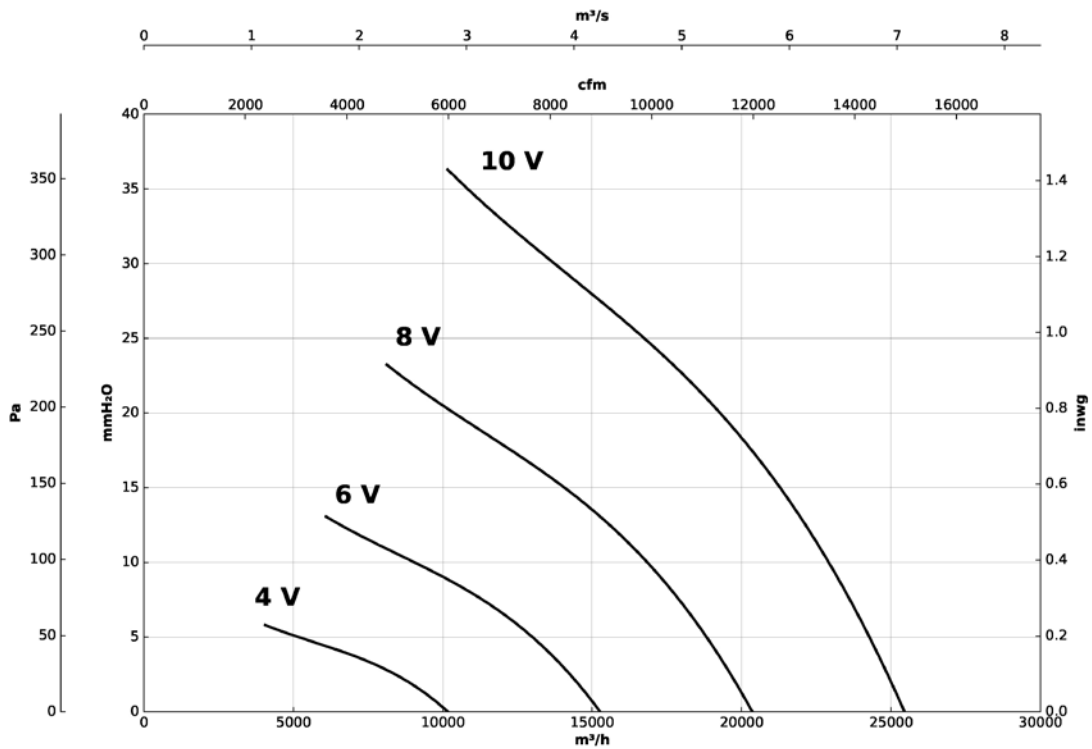

### Characteristic curves

Q= Flow rate in m<sup>3</sup>/h, m<sup>3</sup>/s and cfm

Pe= Static pressure in mm H<sub>2</sub>O, Pa and inwg

#### HFW/EC-80-4T-5.5

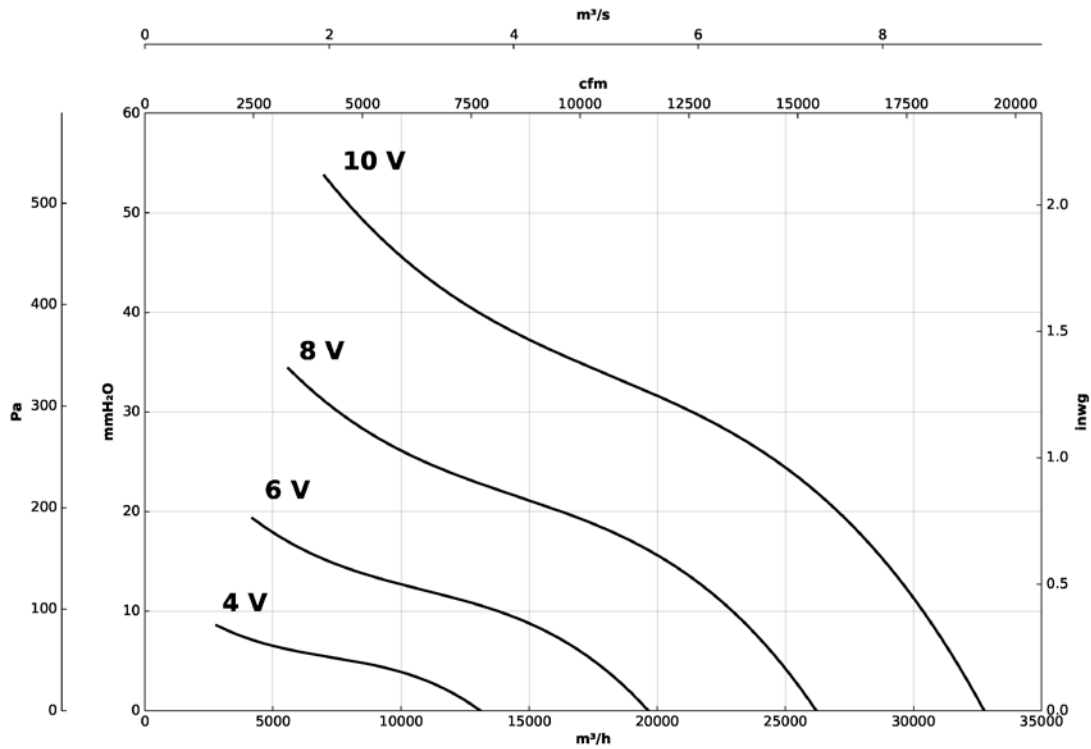

#### HFW/EC-80-6T-3

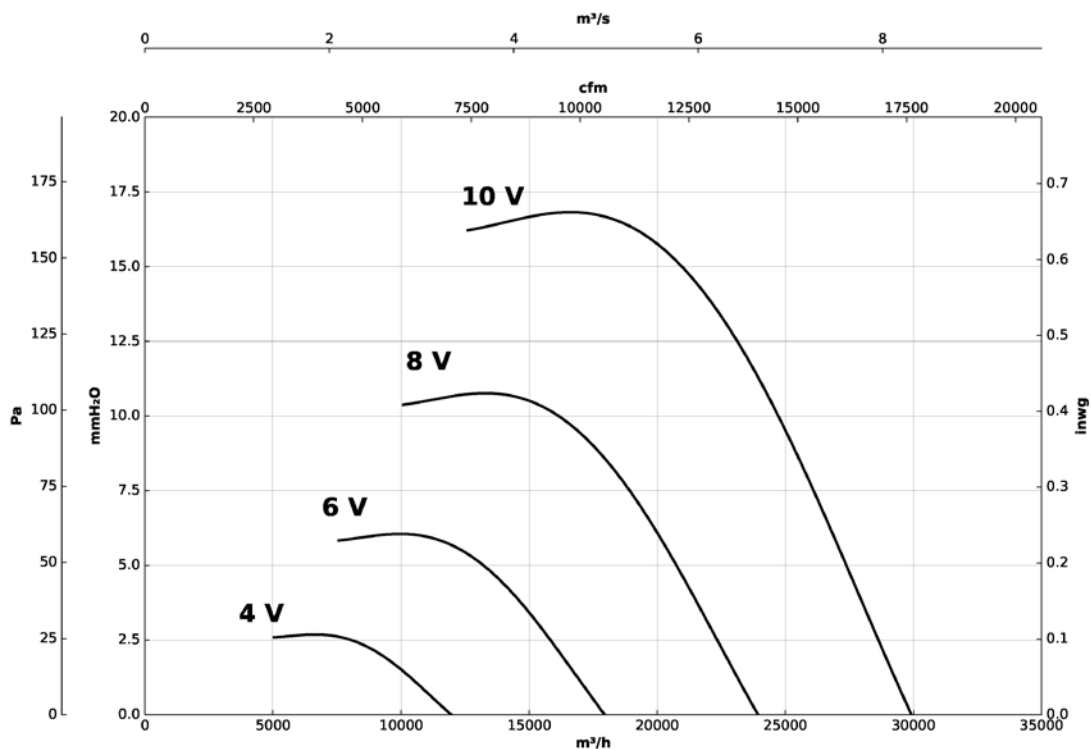

## Characteristic curves

Q= Flow rate in m<sup>3</sup>/h, m<sup>3</sup>/s and cfm

Pe= Static pressure in mm H<sub>2</sub>O, Pa and inwg

### HFW/EC-90-4T-5.5

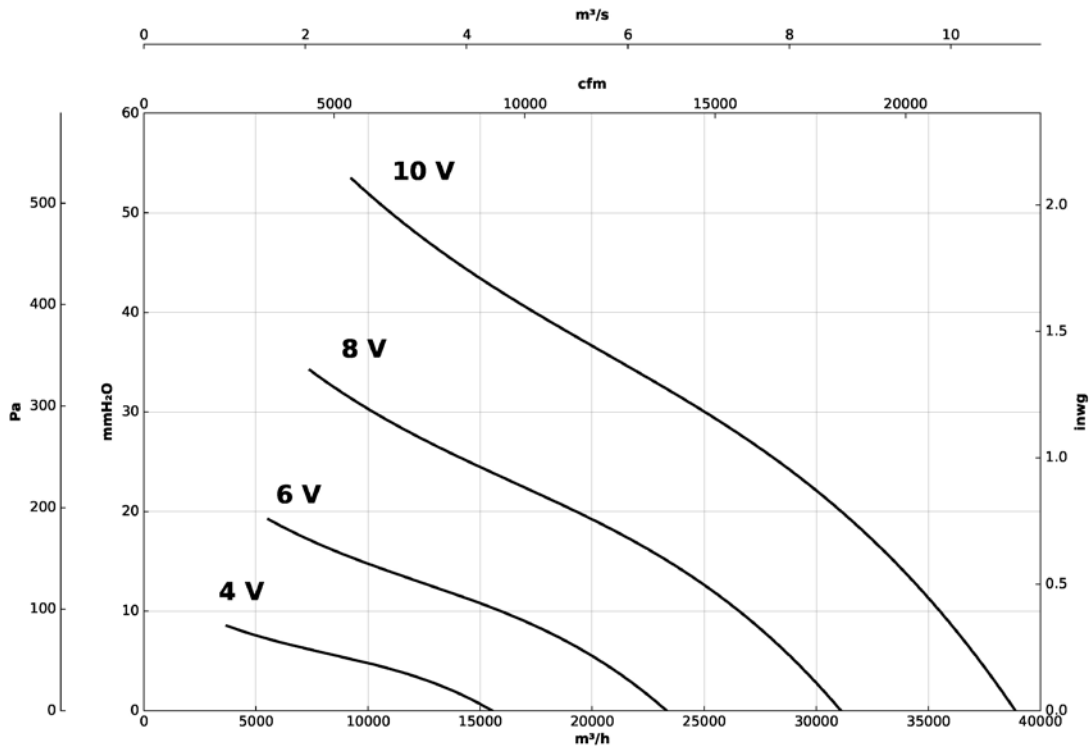

### HFW/EC-90-6T-2

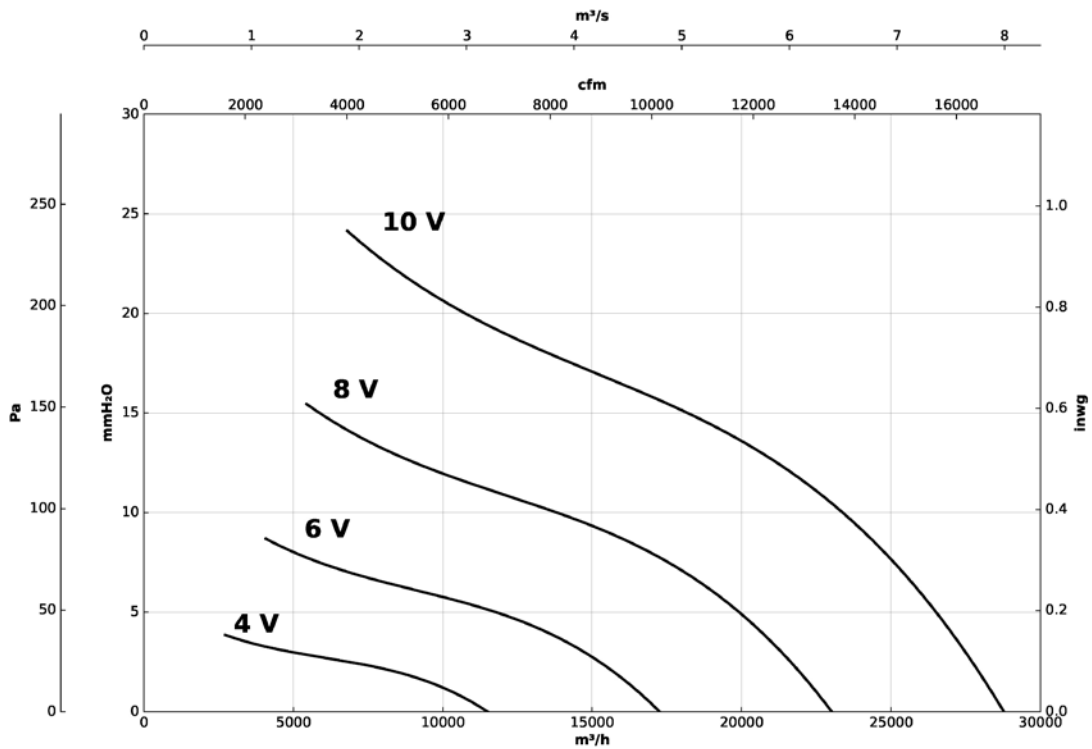

### Characteristic curves

Q= Flow rate in m<sup>3</sup>/h, m<sup>3</sup>/s and cfm

Pe= Static pressure in mm H<sub>2</sub>O, Pa and inwg

**HFW/EC-90-6T-3**

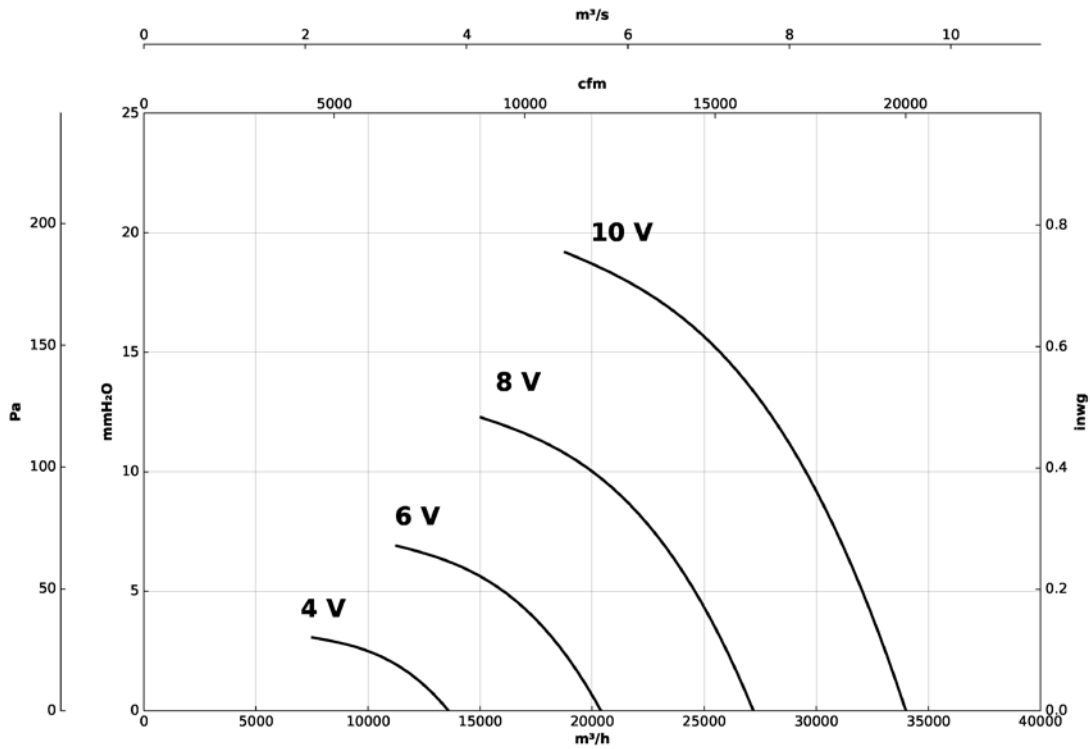

**HFW/EC-100-6T-3**

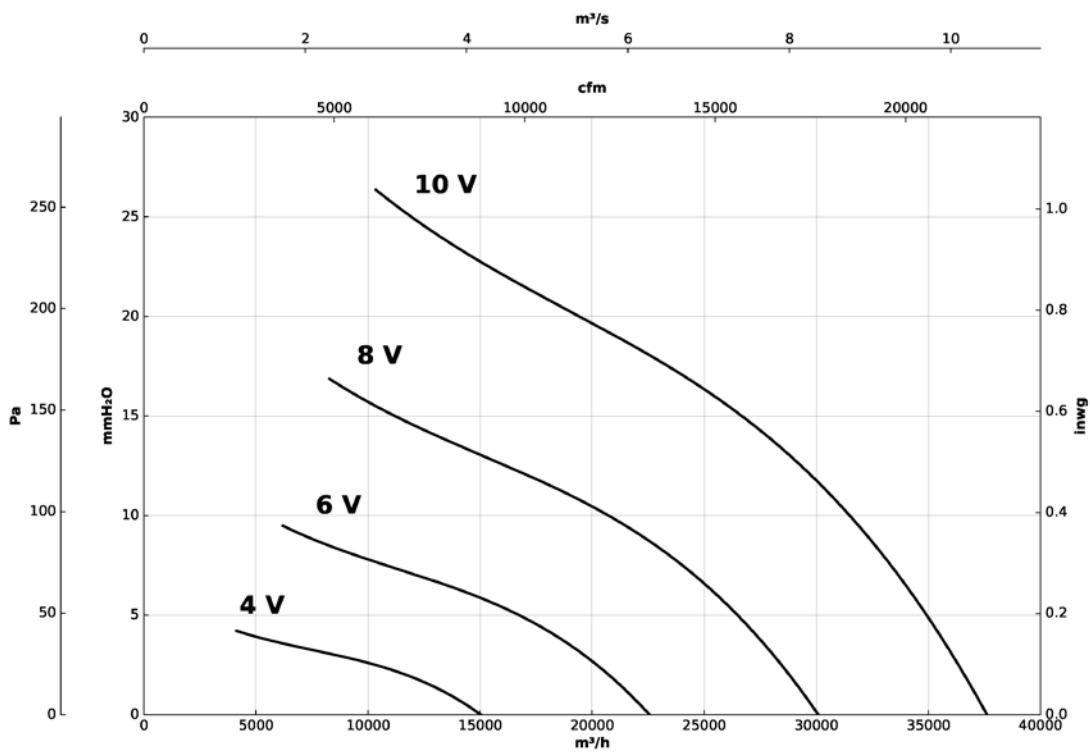

# CBD/EC



**Double inlet centrifugal fans, direct motor EC Technology IE4 with integrated electronics and forward curved impeller**



**EC TECHNOLOGY MOTOR with integrated electronics**



**EC CONTROL**  
Supplied as an optional accessory

Double inlet centrifugal fans, direct motor EC Technology IE4 with integrated electronics and forward curved impeller, specially designed for high energy efficiency.

**Fan:**

- Galvanized steel sheet casing.
- Forward curved impeller in galvanized sheet steel.

**Motor:**

- High efficiency EC Technology motors with integrated electronics, regulated by 0-10 V.
- IE4 efficiency motors, class F and IP54 protection.
- Single-phase 190-250 V 50/60 Hz.
- Working temperature: -25 °C +60 °C.

- CPC: Constant pressure control.
- CFC: Constant flow control.
- DAY / NIGHT: Double pressure setpoint adjustment according to time of day.
- External sensor: compatible with temperature, humidity, air quality or CO sensor.
- Equipment preconfigured in constant pressure mode with 100 Pa setpoint.

**Finish:**

- Anti-corrosive in galvanized steel sheet.

**EC CONTROL:** Supplied as an optional accessory. Control panel for ventilation systems with EC Technology motors with the electronics integrated in the motor itself. With the following characteristics:



High quality, extremely robust impeller, dynamically balanced in accordance with ISO 21940-11

## Order code

**CBD/EC – 2525 – 4M – 3/4 – IE4**

CBD/EC: Double inlet centrifugal fans, direct motor EC Technology IE4 with integrated electronics and forward curved impeller

Impeller size mm

mm	inch
1919	7/7
2525	9/9
2828	10/10
3333	12/12

Number of motor poles

- 4=1400 r/min 50 Hz
- 6=900 r/min 50 Hz

M = Single-phase

Motor power (HP)

IE4 motor

## Technical characteristics

Model	Equivalence inches	Max. speed (r/min)	Maximum admissible current (A) 230V	Max. electric power (kW)	Maximum flow rate (m³/h)	Sound pressure level dB (A)	Approx. weight (Kg)	According ErP *
CBD/EC-1919-4M-1/5 IE4	7/7	1400	1.65	0.18	1520	59	9	Excluded
CBD/EC-1919-6M-1/10 IE4	7/7	900	0.98	0.09	1374	53	9	Excluded
CBD/EC-2525-4M-1/2 IE4	9/9	1400	1.64	0.37	2400	66	10	2020
CBD/EC-2525-4M-3/4 IE4	9/9	1400	2.37	0.55	3200	70	11	2020
CBD/EC-2525-4M-1 IE4	9/9	1400	3.12	0.75	4200	71	12	2020
CBD/EC-2525-6M-1/3 IE4	9/9	900	1.07	0.25	2785	62	11	2020
CBD/EC-2828-4M-1 IE4	10/10	1400	4.12	0.75	3827	72	13	2020
CBD/EC-2828-4M-2 IE4	10/10	1410	11.04	1.50	5915	74	15	2020
CBD/EC-2828-6M-1/3 IE4	10/10	900	1.10	0.25	3046	62	13	2020
CBD/EC-3333-6M-1 IE4	12/12	900	7.83	1.10	5200	71	21	2020

\* In accordance with the ErP 2020 draft



## Erp. (Energy Related Products)

Information on Directive 2009/125/EC can be downloaded from the SODECA website or the QuickFan selector programme.

## Acoustic characteristics

The indicated values are determined by measuring the sound pressure level and sound power in dB(A) obtained in a free field at a distance equivalent to twice the size of the fan plus the impeller diameter, with a minimum of 1.5 m.

Sound power spectrum Lw(A) in dB(A) per Hz frequency band

	63	125	250	500	1000	2000	4000	8000		63	125	250	500	1000	2000	4000	8000
1919-4M-1/5 IE4	29	44	55	63	65	64	63	55	2525-6M-1/3 IE4	32	47	58	66	68	67	66	58
1919-6M-1/10 IE4	23	38	49	57	59	58	57	49	2828-4M-1 IE4	42	57	68	76	78	77	76	68
2525-4M-1/2 IE4	36	51	62	70	72	71	70	62	2828-4M-2 IE4	44	59	70	78	80	79	78	70
2525-4M-3/4 IE4	40	55	66	74	76	75	74	66	2828-6M-1/3 IE4	32	47	58	66	68	67	66	58
2525-4M-1 IE4	41	56	67	75	77	76	75	67	3333-6M-1 IE4	41	56	67	75	77	76	75	67

## Dimensions mm

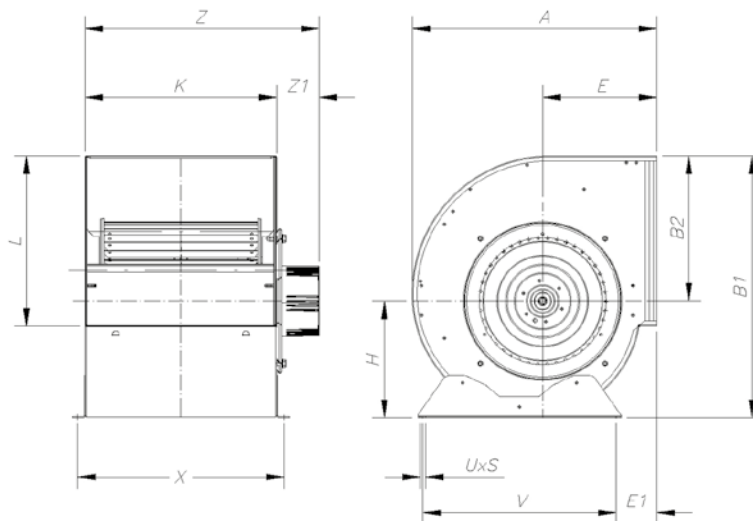

	Equivalence inches	A	B1	B2	E	E1	H	K	L	UxS	V	X	Z1	Z
CBD/EC-1919	7/7	315	333	189	152	64	144	230	208	9x16	225	258	35	265
CBD/EC-2525	9/9	380	400	218	183	78	182	300	263	9x16	275	328	85	385
CBD/EC-2828	10/10	422	450	246	202	73	204	326	292	9x16	315	352	55	381
CBD/EC-3333	12/12	493	526	290	230	82	236	387	345	9x16	390	415	85	472

## Accessories



INT



EC CONTROL



MTP



SI-PRESIÓN



SI-TEMP IND



SI-MF



SI-CO2 IND



SI-HUMEDAD

## Characteristic curves

Q= Flow rate in m<sup>3</sup>/h, m<sup>3</sup>/s and cfm

Pe= Static pressure in mm H<sub>2</sub>O, Pa and inwg

### 1919-4M-1/5 IE4

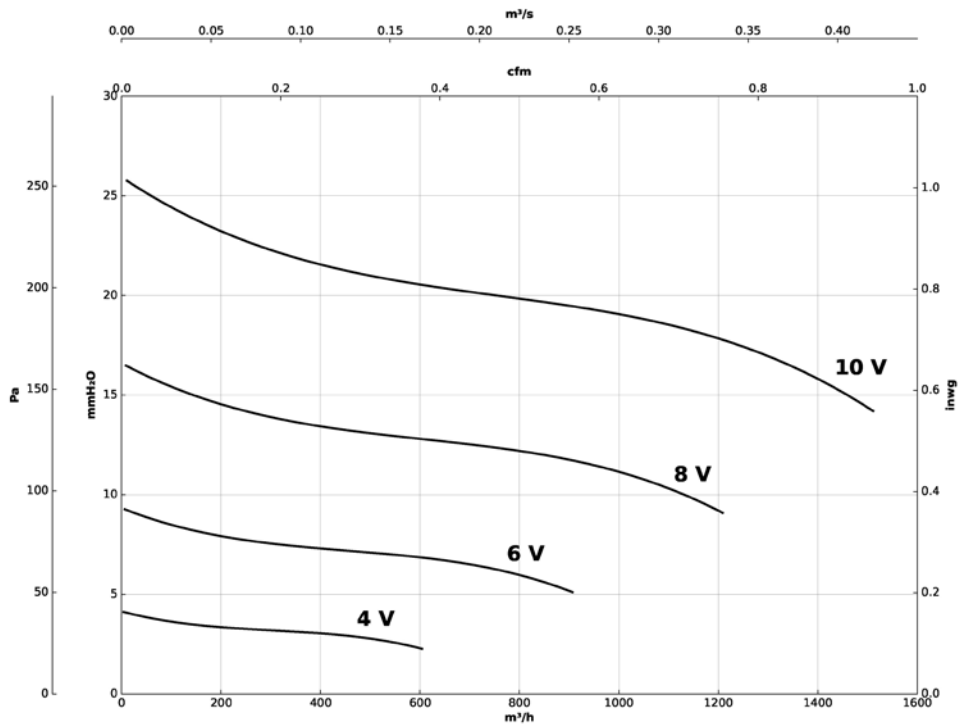

### 1919-6M-1/10 IE4

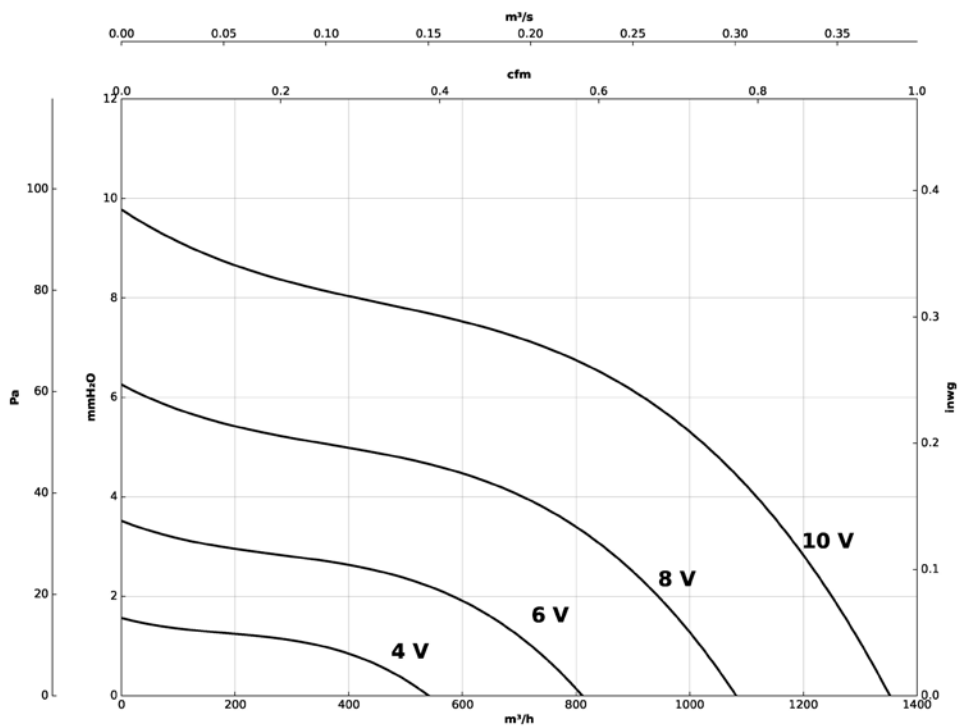



### Characteristic curves

Q= Flow rate in m<sup>3</sup>/h, m<sup>3</sup>/s and cfm

Pe= Static pressure in mm H<sub>2</sub>O, Pa and inwg

#### 2525-4M-1/2 IE4

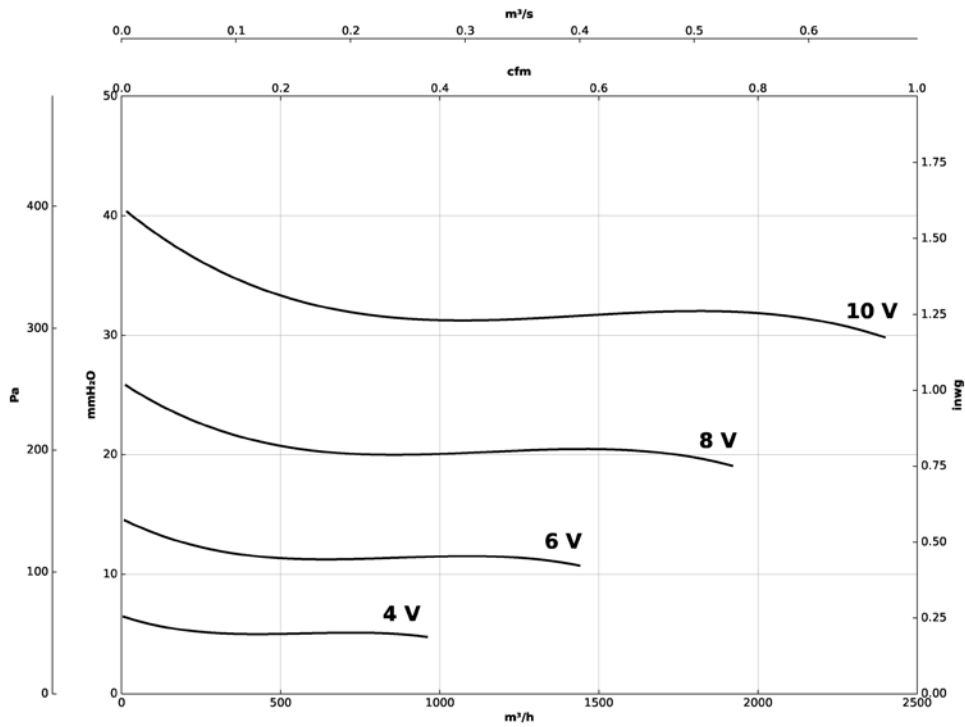

#### 2525-4M-3/4 IE4

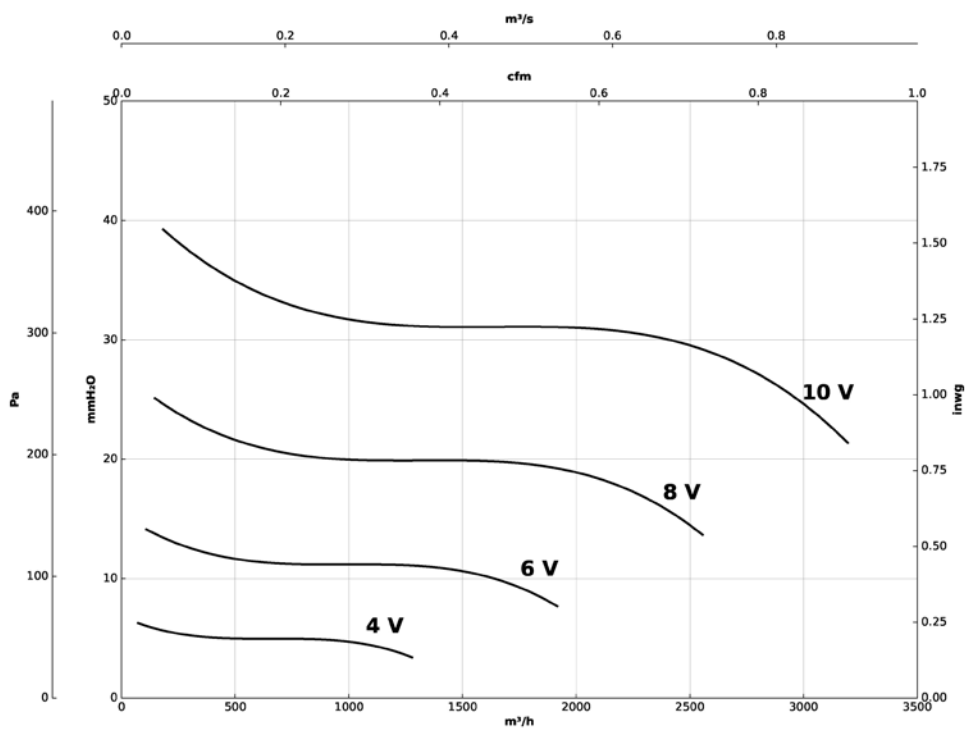

## Characteristic curves

Q= Flow rate in m<sup>3</sup>/h, m<sup>3</sup>/s and cfm

Pe= Static pressure in mm H<sub>2</sub>O, Pa and inwg

### 2525-4M-1 IE4

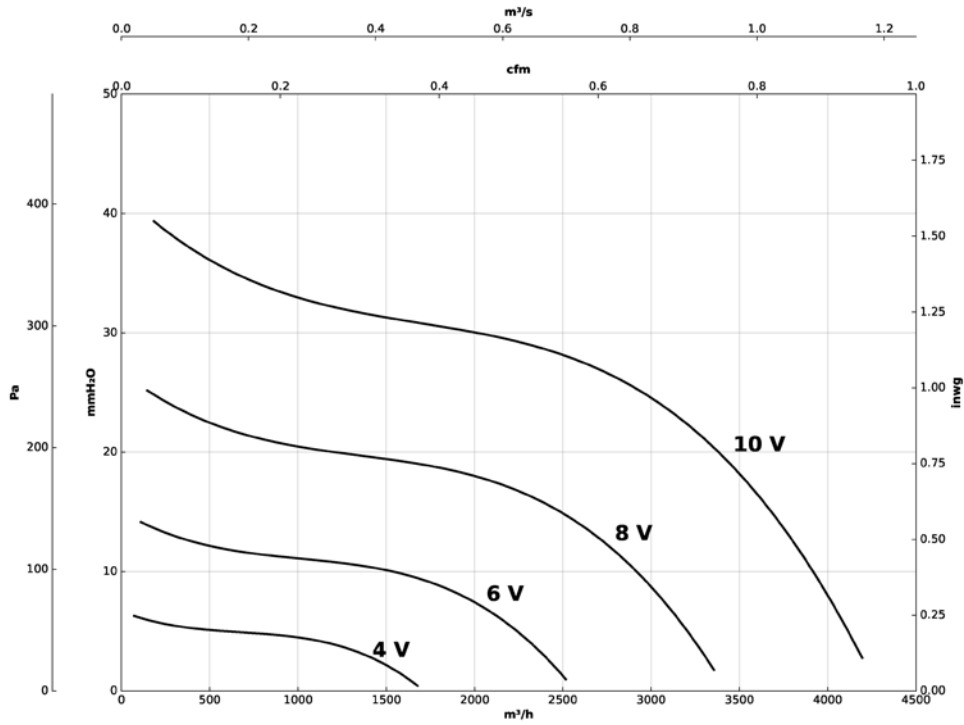

### 2525-6M-1/3 IE4

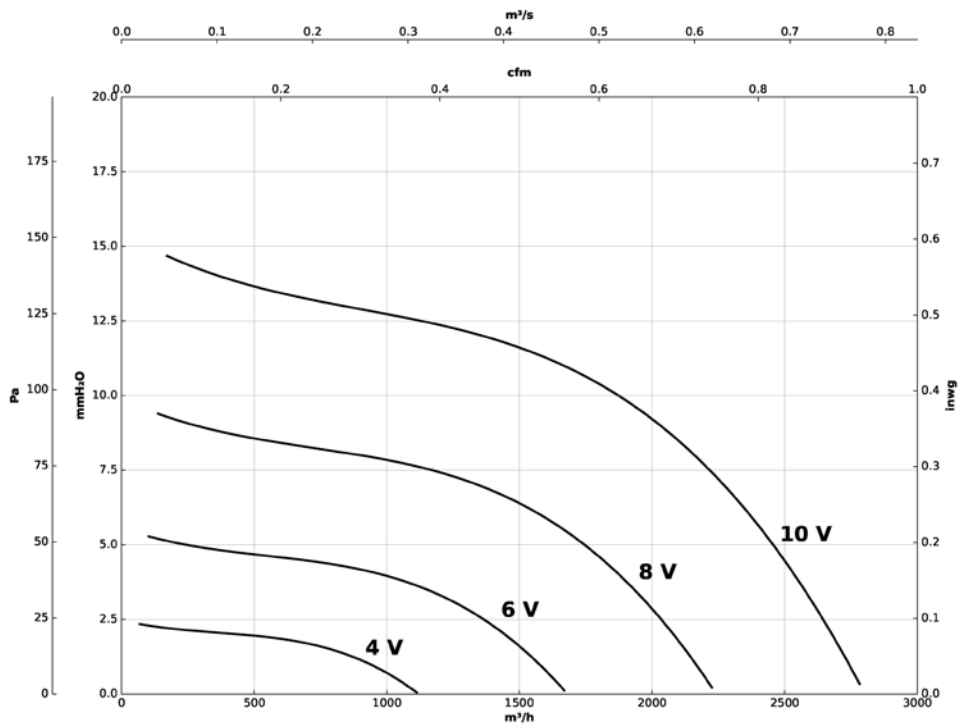

### Characteristic curves

Q= Flow rate in m<sup>3</sup>/h, m<sup>3</sup>/s and cfm

Pe= Static pressure in mm H<sub>2</sub>O, Pa and inwg

#### 2828-4M-1 IE4

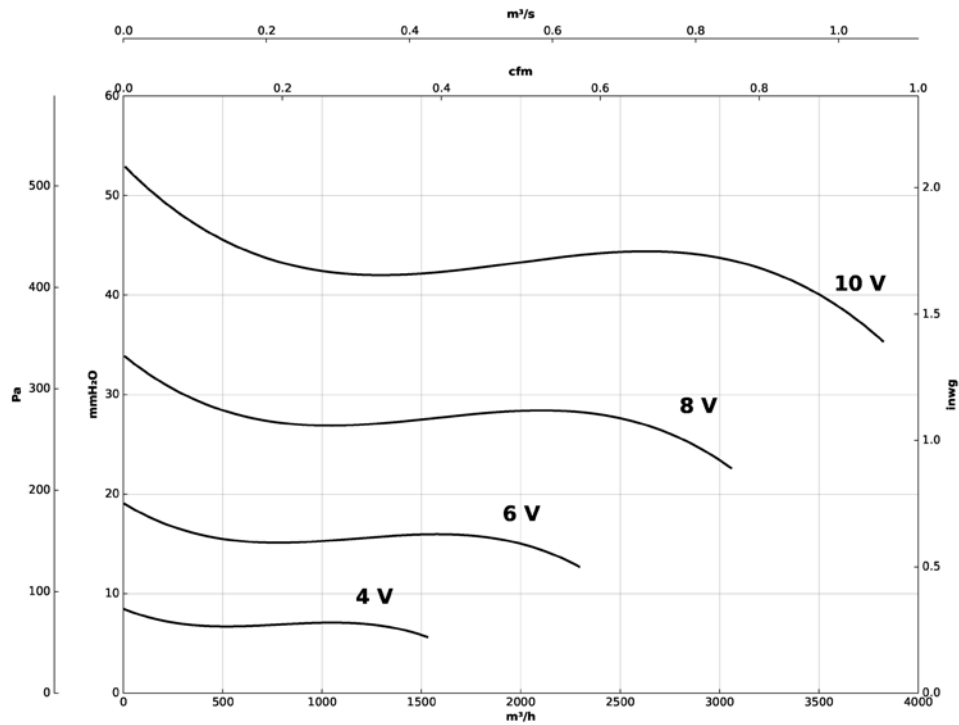

#### 2828-4M-2 IE4

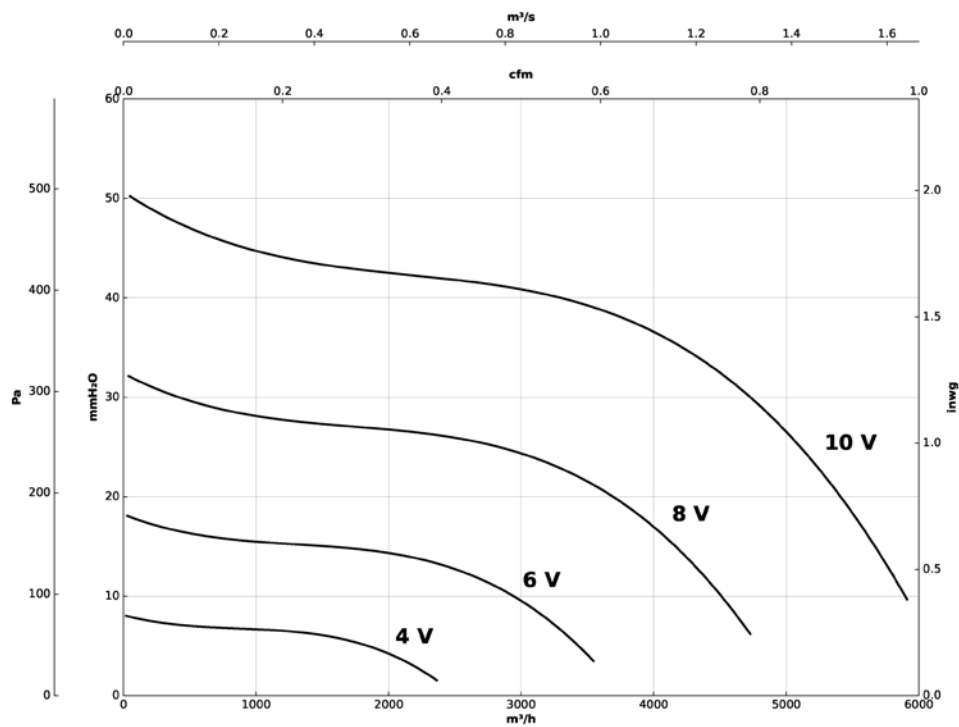

## Characteristic curves

Q= Flow rate in m<sup>3</sup>/h, m<sup>3</sup>/s and cfm

Pe= Static pressure in mm H<sub>2</sub>O, Pa and inwg

### 2828-6M-1/3 IE4

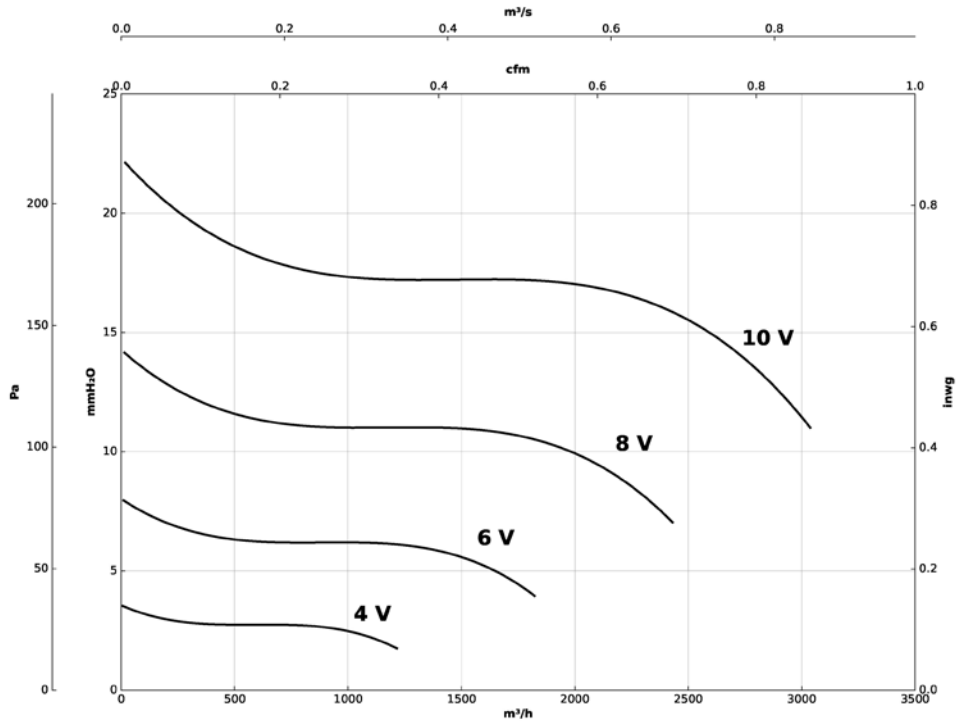

### 3333-6M-1 IE4

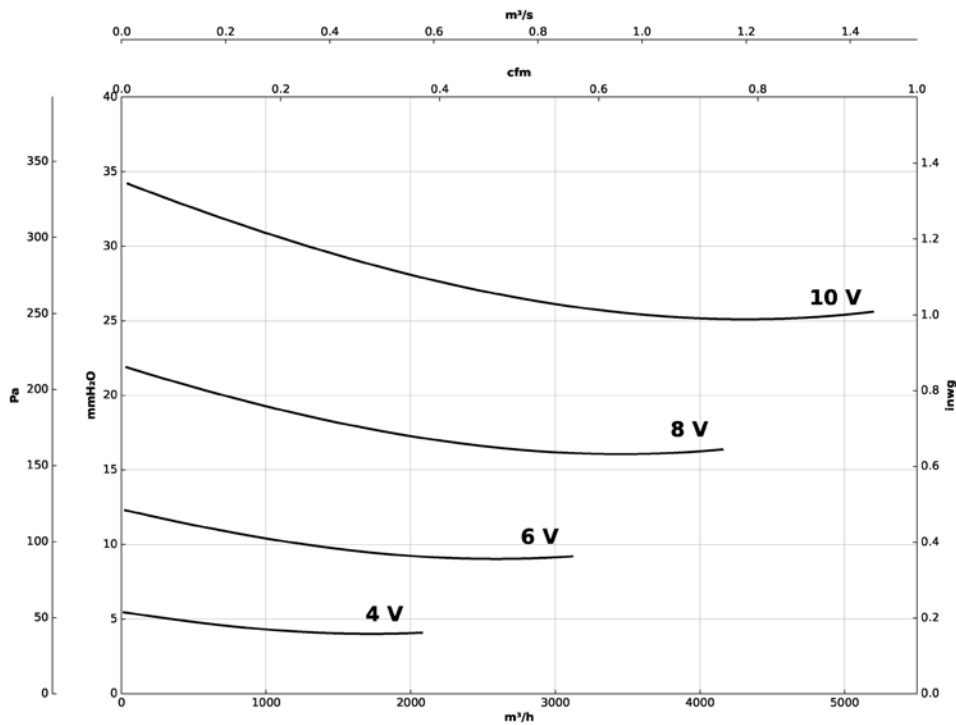

# CBD/B/EC



**Double inlet centrifugal fans, direct motor EC Technology IE4 with integrated electronics and without support feet**



**EC TECHNOLOGY MOTOR with integrated electronics**



**EC CONTROL**  
Supplied as an optional accessory

Double inlet centrifugal fans, direct motor EC Technology IE4 with integrated electronics and forward curved impeller, specially designed for high energy efficiency.

**Fan:**

- Galvanized steel sheet casing.
- Forward curved impeller in galvanized sheet steel.
- Supplied with inlet flange and without support feet.

**Motor:**

- High efficiency EC Technology motors with integrated electronics, regulated by 0-10 V.
- IE4 efficiency motors, class F and IP54 protection.
- Single-phase 190-250 V 50/60 Hz.
- Working temperature: -25 °C +60 °C.

the electronics integrated in the motor itself. With the following characteristics:

- CPC: Constant pressure control.
- CFC: Constant flow control.
- DAY / NIGHT: Double pressure setpoint adjustment according to time of day.
- External sensor: compatible with temperature, humidity, air quality or CO sensor.
- Equipment preconfigured in constant pressure mode with 100 Pa set point.

**Finish:**

- Anti-corrosive in galvanized steel sheet.



High quality, extremely robust impeller, dynamically balanced in accordance with ISO 21940-11

**EC CONTROL:** Supplied as an optional accessory. Control panel for ventilation systems with EC Technology motors with

## Order code

**CBD/B/EC – 2525 – 4M – 3/4 – IE4**

CBD/B/EC: Double inlet centrifugal fans, direct motor EC Technology IE4 with integrated electronics and without support feet

Impeller size mm

mm	inch
1919	7/7
2525	9/9
2828	10/10
3333	12/12

Number of motor poles

4=1400 r/min 50 Hz  
6=900 r/min 50 Hz

M = Single-phase

Motor power (HP)

IE4 motor

## Technical characteristics

Model	Equivalence inches	Max. speed (r/min)	Maximum admissible current (A)	Max. electric power (kW)	Maximum flow rate (m³/h)	Sound pressure level dB (A)	Approx. weight (Kg)	According ErP *
			230V					
CBD/B/EC-1919-4M-1/5 IE4	7/7	1400	1.65	0.18	1520	59	9	Excluded
CBD/B/EC-1919-6M-1/10 IE4	7/7	900	0.98	0.09	1374	53	9	Excluded
CBD/B/EC-2525-4M-1/2 IE4	9/9	1400	1.64	0.37	2400	66	10	2020
CBD/B/EC-2525-4M-3/4 IE4	9/9	1400	2.37	0.55	3200	70	11	2020
CBD/B/EC-2525-4M-1 IE4	9/9	1400	3.12	0.75	4200	71	12	2020
CBD/B/EC-2525-6M-1/3 IE4	9/9	900	1.07	0.25	2785	62	11	2020
CBD/B/EC-2828-4M-1 IE4	10/10	1400	4.12	0.75	3827	72	13	2020
CBD/B/EC-2828-4M-2 IE4	10/10	1410	11.04	1.50	5915	74	15	2020
CBD/B/EC-2828-6M-1/3 IE4	10/10	900	1.10	0.25	3046	62	13	2020
CBD/B/EC-3333-6M-1 IE4	12/12	900	7.83	1.10	5200	71	21	2020

\* In accordance with the ErP 2020 draft



## Erp. (Energy Related Products)

Information on Directive 2009/125/EC can be downloaded from the SODECA website or the QuickFan selector programme.

### Acoustic characteristics

The indicated values are determined by measuring the sound pressure level and sound power in dB(A) obtained in a free field at a distance equivalent to twice the size of the fan plus the impeller diameter, with a minimum of 1.5 m.

Sound power spectrum Lw(A) in dB(A) per Hz frequency band

	63	125	250	500	1000	2000	4000	8000		63	125	250	500	1000	2000	4000	8000
1919-4M-1/5 IE4	29	44	55	63	65	64	63	55	2525-6M-1/3 IE4	32	47	58	66	68	67	66	58
1919-6M-1/10 IE4	23	38	49	57	59	58	57	49	2828-4M-1 IE4	42	57	68	76	78	77	76	68
2525-4M-1/2 IE4	36	51	62	70	72	71	70	62	2828-4M-2 IE4	44	59	70	78	80	79	78	70
2525-4M-3/4 IE4	40	55	66	74	76	75	74	66	2828-6M-1/3 IE4	32	47	58	66	68	67	66	58
2525-4M-1 IE4	41	56	67	75	77	76	75	67	3333-6M-1 IE4	41	56	67	75	77	76	75	67

### Dimensions mm

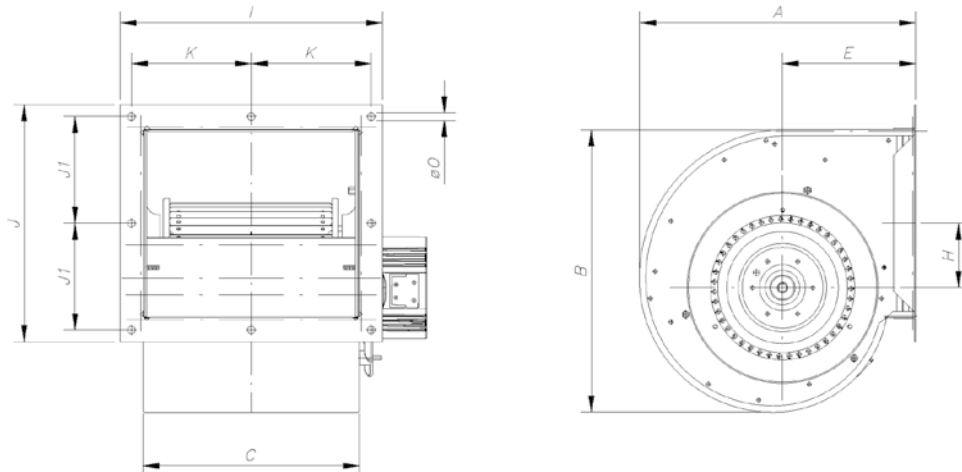

	Equivalence inches	A	B	C	E	H	I	J	J1	K	øO
CBD/B/EC-1919	7/7	315	322	230	152	86.5	295	273	120.5	131.5	10
CBD/B/EC-2525	9/9	385	393	300	183	89	365	328	148	166.5	10
CBD/B/EC-2828	10/10	426	442	326	202	102	391	357	162.5	179.5	10
CBD/B/EC-3333	12/12	497	527	387	230	121	452	410	189	210	10

### Characteristic curves

See series characteristic curves: CBD/EC

### Accessories



INT



EC CONTROL



MTP



SI-PRESIÓN



SI-TEMP IND



SI-MF



SI-CO2 IND



SI-HUMEDAD



PSB

# CJBD/EC



**Acoustically insulated ventilation units and EC Technology IE4 motor with integrated electronics**



EC TECHNOLOGY MOTOR with integrated electronics

Ventilation units with forward curved impeller and EC Technology IE4 motor with integrated electronics, specially designed to obtain high energy efficiency.

**Fan:**

- Galvanized steel sheet casing.
- Forward curved impeller in galvanized sheet steel.

**Motor:**

- High efficiency EC Technology motors with integrated electronics, regulated by 0-10 V.
- IE4 efficiency motors, class F and IP54 protection.

- Single-phase 190-250 V 50/60 Hz.
- Working temperature: -25 °C +60 °C.

**Finish:**

- Anti-corrosive in galvanized steel sheet.



With support foot to facilitate mounting.

## Order code

<b>CJBD/EC</b>	—	<b>2525</b>	—	<b>4M</b>	—	<b>3/4</b>	—	<b>IE4</b>
↓		↓		↓		↓		↓
CJBD/EC: Acoustically insulated ventilation units and EC Technology IE4 motor with integrated electronics		Impeller size mm mm    inch 1919   7/7 2525   9/9 2828   10/10 3333   12/12		Number of motor poles 4=1400 r/min 50 Hz 6=900 r/min 50 Hz		M = Single-phase Motor power (HP)		IE4 motor

## Technical characteristics

Model	Equivalence inches	Max. speed (r/min)	Maximum admissible current (A) 230V	Max. electric power (kW)	Maximum flow rate (m³/h)	Sound pressure level dB (A)	Approx. weight (Kg)	According ErP
CJBD/EC-1919-4M-1/5 IE4	7/7	1400	1.65	0.18	1520	60	21	2018
CJBD/EC-1919-6M-1/10 IE4	7/7	900	0.98	0.09	1374	55	21	2018
CJBD/EC-2525-4M-1/2 IE4	9/9	1400	1.64	0.37	2400	68	24	2018
CJBD/EC-2525-4M-3/4 IE4	9/9	1400	2.37	0.55	3200	72	25	2018
CJBD/EC-2525-4M-1 IE4	9/9	1400	3.12	0.75	4200	73	26	2018
CJBD/EC-2525-6M-1/3 IE4	9/9	900	1.07	0.25	2785	63	25	2018
CJBD/EC-2828-4M-1 IE4	10/10	1400	4.12	0.75	3827	74	30	2018
CJBD/EC-2828-4M-2 IE4	10/10	1400	11.04	1.50	5915	76	32	2018
CJBD/EC-2828-6M-1/3 IE4	10/10	900	1.10	0.25	3046	63	31	2018
CJBD/EC-3333-6M-1 IE4	12/12	900	7.83	1.10	5200	72	45	2018



### Erp. (Energy Related Products)

Information on Directive 2009/125/EC can be downloaded from the SODECA website or the QuickFan selector programme.

## Acoustic characteristics

The indicated values are determined by measuring the sound pressure level and sound power in dB(A) obtained in a free field at a distance equivalent to twice the size of the fan plus the impeller diameter, with a minimum of 1.5 m.

Sound power spectrum Lw(A) in dB(A) per Hz frequency band

	63	125	250	500	1000	2000	4000	8000
1919-4M-1/5 IE4	45	56	60	64	66	65	64	55
1919-6M-1/10 IE4	40	51	55	59	61	60	59	50
2525-4M-1/2 IE4	53	64	68	72	74	73	72	63
2525-4M-3/4 IE4	57	68	72	76	78	77	76	67
2525-4M-1 IE4	58	69	73	77	79	78	77	68
2525-6M-1/3 IE4	48	59	63	67	69	68	67	58
2828-4M-1 IE4	59	70	74	78	80	79	78	69
2828-4M-2 IE4	61	72	76	80	82	81	80	71
2828-6M-1/3 IE4	48	59	63	67	69	68	67	58
3333-6M-1 IE4	57	68	72	76	78	77	76	67

## Dimensions mm

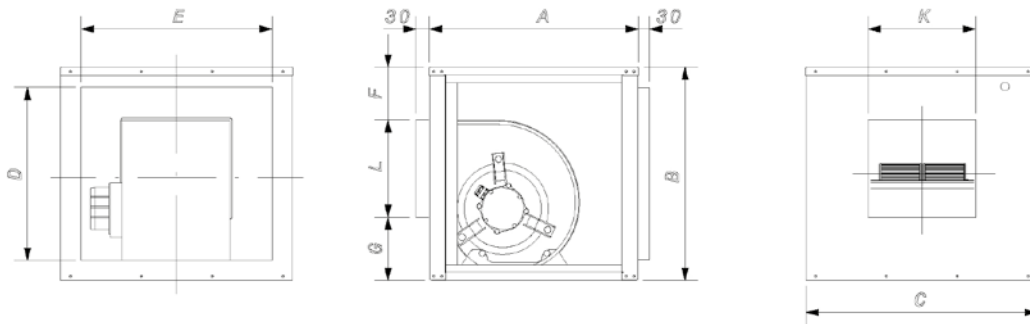

	Equivalence inches	A	B	C	D	E	F	G	K	L
CJBD/EC-1919	7/7	450	460	500	370	410	115	135	232	210
CJBD/EC-2525	9/9	500	522	550	426	454	107	147	303	268
CJBD/EC-2828	10/10	550	575	600	479	504	104	177	330	294
CJBD/EC-3333	12/12	650	650	700	554	604	105	198	392	347

## Characteristic curves

See series characteristic curves: CBD/EC

## Accessories



INT



EC CONTROL



MTP



TEJ



VIS



SI-PRESIÓN



SI-TEMP IND



SI-MF



SI-CO2 IND



SI-HUMEDAD



# CJBD/EC/CPC

Acoustically isolated ventilation units, EC Technology IE4 motor with integrated electronics and constant pressure control



EC TECHNOLOGY MOTOR with integrated electronics

Ventilation units with forward curved impeller, EC Technology IE4 motor with integrated electronics and constant pressure control, specially designed to obtain high energy efficiency.

**Fan:**

- Galvanized steel sheet casing.
- Forward curved impeller in galvanized sheet steel.

**Motor:**

- High efficiency EC Technology motors with integrated electronics, regulated by 0-10 V.
- IE4 efficiency motors, class F and IP54 protection.
- Single-phase 190-250 V 50/60 Hz.
- Working temperature: -25 °C +60 °C.

EC CONTROL: Supplied as an optional accessory. Control panel for ventilation systems with EC Technology motors with the electronics integrated in the motor itself. With the following characteristics:

- CPC: Constant pressure control.
- CFC: Constant flow control.
- DAY / NIGHT: Double pressure setpoint adjustment according to time of day.
- External sensor: compatible with temperature, humidity, air quality or CO sensor.
- Equipment preconfigured in constant pressure mode with 100 Pa set point.

**Finish:**

- Anti-corrosive in galvanized steel sheet.

## Order code

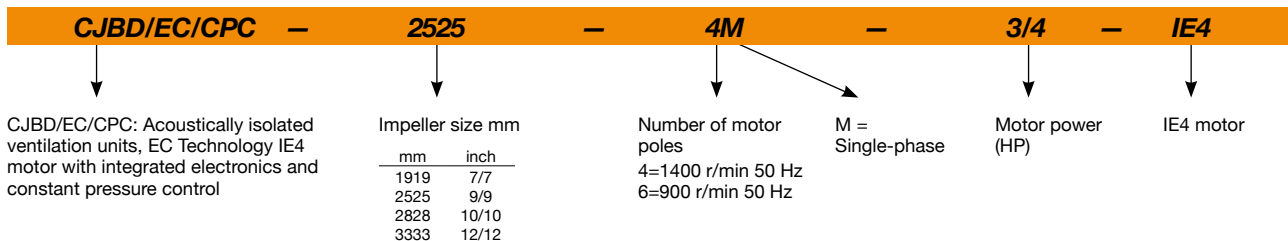

## Technical characteristics

Model	Equivalence inches	Max. speed (r/min)	Maximum admissible current (A)	Max. electric power (kW)	Maximum flow rate (m³/h)	Sound pressure level dB (A)	Approx. weight (Kg)	According ErP
			230V					
CJBD/EC/CPC-1919-4M-1/5 IE4	7/7	1400	1.65	0.18	1520	60	21	2018
CJBD/EC/CPC-1919-6M-1/10 IE4	7/7	900	0.98	0.09	1374	55	21	2018
CJBD/EC/CPC-2525-4M-1/2 IE4	9/9	1400	1.64	0.37	2400	68	24	2018
CJBD/EC/CPC-2525-4M-3/4 IE4	9/9	1400	2.37	0.55	3200	72	25	2018
CJBD/EC/CPC-2525-4M-1 IE4	9/9	1400	3.12	0.75	4200	73	26	2018
CJBD/EC/CPC-2525-6M-1/3 IE4	9/9	900	1.07	0.25	2785	63	25	2018
CJBD/EC/CPC-2828-4M-1 IE4	10/10	1400	4.12	0.75	3827	74	30	2018
CJBD/EC/CPC-2828-4M-2 IE4	10/10	1400	11.04	1.50	5915	76	32	2018
CJBD/EC/CPC-2828-6M-1/3 IE4	10/10	900	1.10	0.25	3046	63	31	2018
CJBD/EC/CPC-3333-6M-1 IE4	12/12	900	7.83	1.10	5200	72	45	2018



## Erp. (Energy Related Products)

Information on Directive 2009/125/EC can be downloaded from the SODECA website or the QuickFan selector programme.

### Acoustic characteristics

The indicated values are determined by measuring the sound pressure level and sound power in dB(A) obtained in a free field at a distance equivalent to twice the size of the fan plus the impeller diameter, with a minimum of 1.5 m.

Sound power spectrum Lw(A) in dB(A) per Hz frequency band

	63	125	250	500	1000	2000	4000	8000
1919-4M-1/5 IE4	45	56	60	64	66	65	64	55
1919-6M-1/10 IE4	40	51	55	59	61	60	59	50
2525-4M-1/2 IE4	53	64	68	72	74	73	72	63
2525-4M-3/4 IE4	57	68	72	76	78	77	76	67
2525-4M-1 IE4	58	69	73	77	79	78	77	68
2525-6M-1/3 IE4	48	59	63	67	69	68	67	58
2828-4M-1 IE4	59	70	74	78	80	79	78	69
2828-4M-2 IE4	61	72	76	80	82	81	80	71
2828-6M-1/3 IE4	48	59	63	67	69	68	67	58
3333-6M-1 IE4	57	68	72	76	78	77	76	67

### Dimensions mm

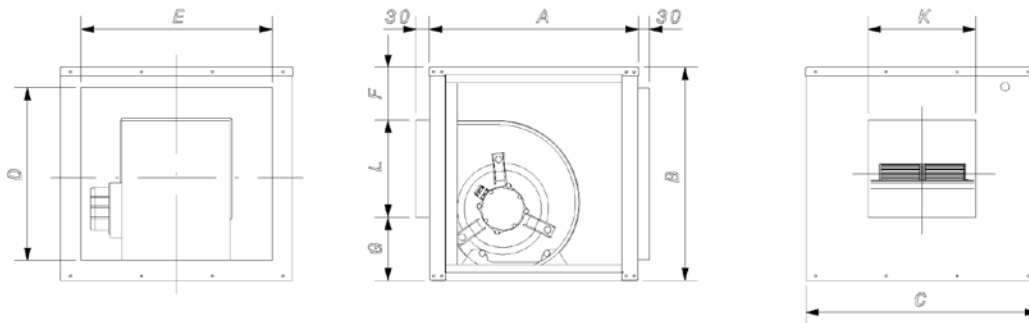

	Equivalence inches	A	B	C	D	E	F	G	K	L
CJBD/EC/CPC-1919	7/7	450	460	500	370	410	115	135	232	210
CJBD/EC/CPC-2525	9/9	500	522	550	426	454	107	147	303	268
CJBD/EC/CPC-2828	10/10	550	575	600	479	504	104	177	330	294
CJBD/EC/CPC-3333	12/12	650	650	700	554	604	105	198	392	347

### Accessories



INT



TEJ



VIS



SI-TEMP IND



SI-MF



SI-CO2 IND



SI-HUMEDAD

## Characteristic curves

Q= Flow rate in m<sup>3</sup>/h, m<sup>3</sup>/s and cfm

Pe= Static pressure in mm H<sub>2</sub>O, Pa and inwg

**CJBD/EC/CPC-1919-4M-1/5**

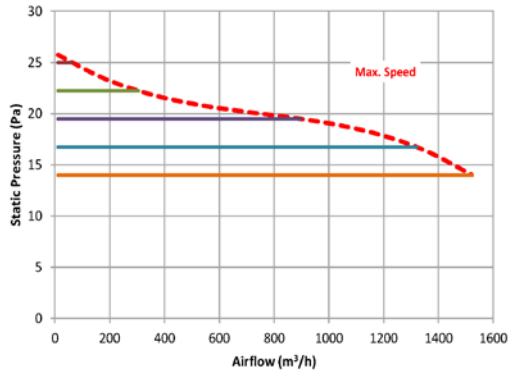

**CJBD/EC/CPC-1919-6M-1/10**

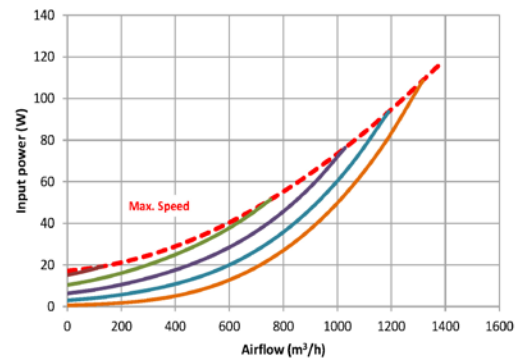
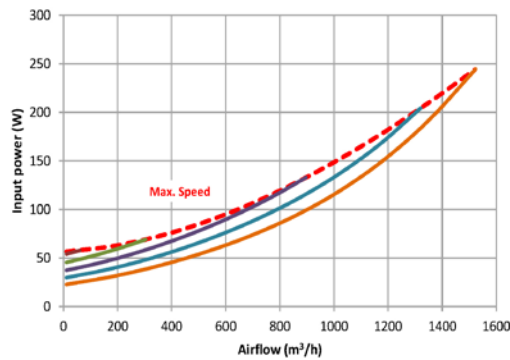
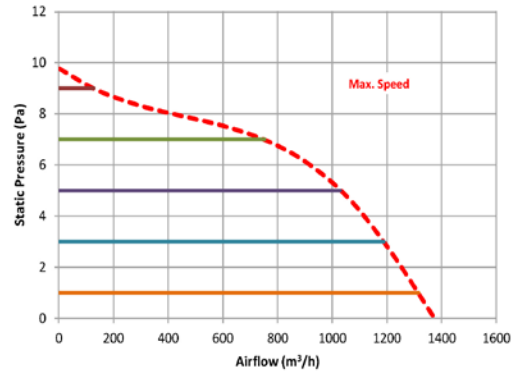

**CJBD/EC/CPC-2525-4M-1/2**

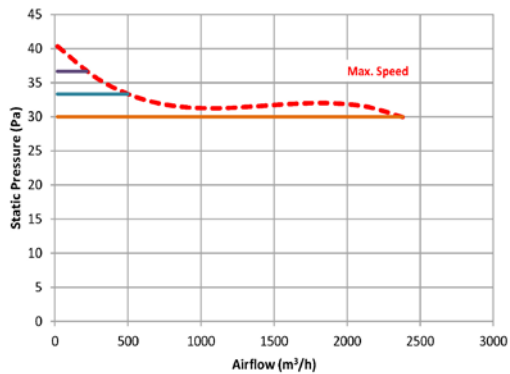

**CJBD/EC/CPC-2525-4M-3/4**

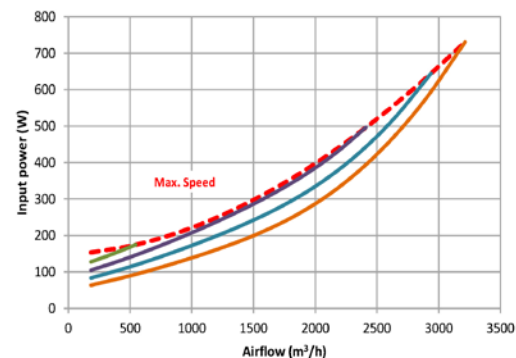
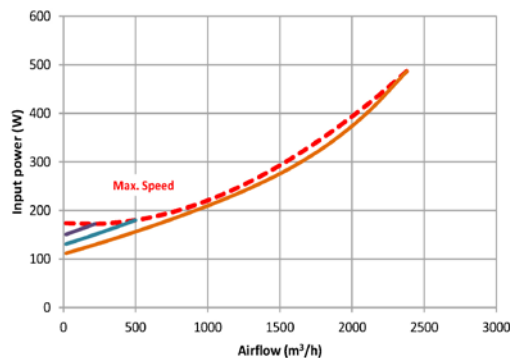
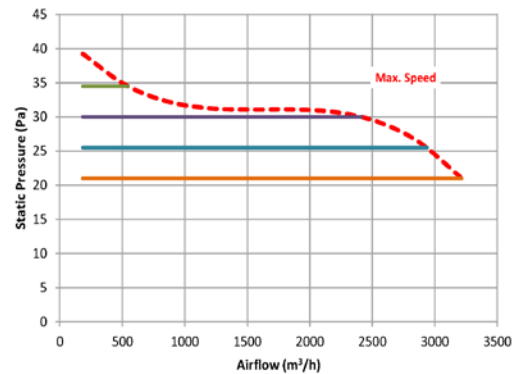

## Characteristic curves

Q= Flow rate in m<sup>3</sup>/h, m<sup>3</sup>/s and cfm

Pe= Static pressure in mm H<sub>2</sub>O, Pa and inwg

**CJBD/EC/CPC-2525-4M-1**

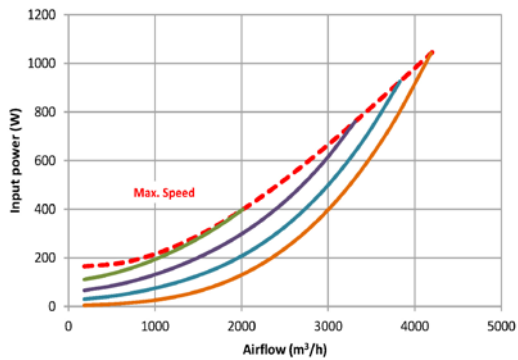
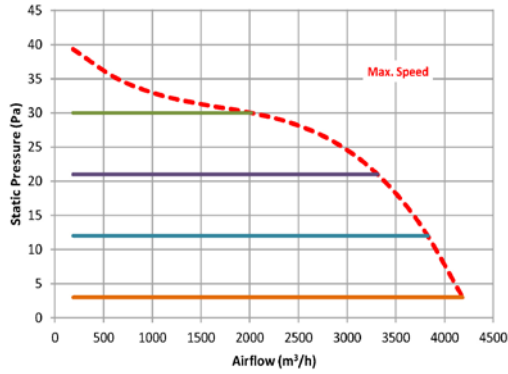

**CJBD/EC/CPC-2525-6M-1/3**

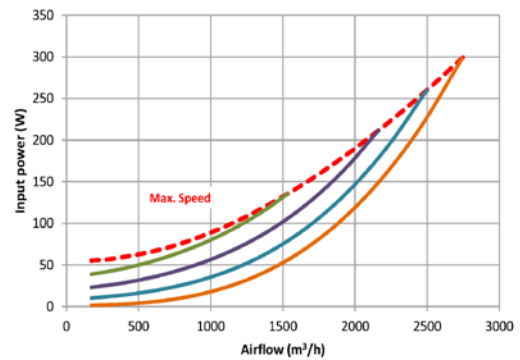
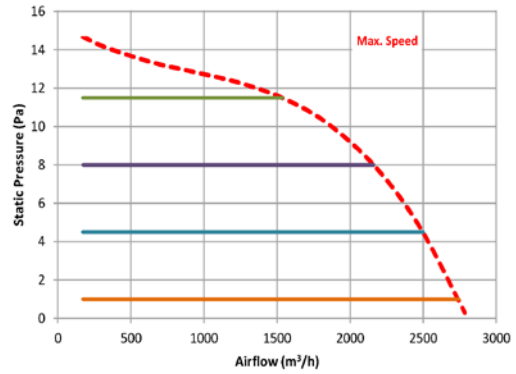

**CJBD/EC/CPC-2828-4M-1**

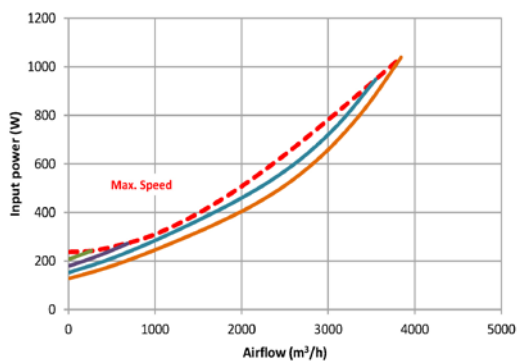
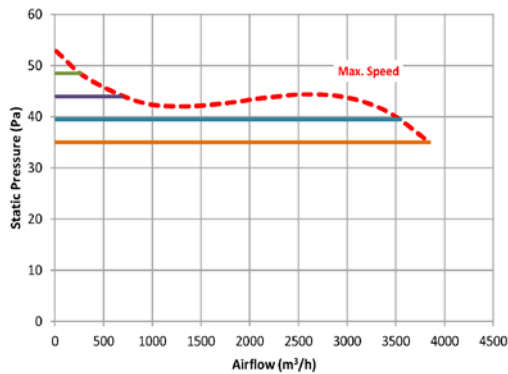

**CJBD/EC/CPC-2828-4M-2**

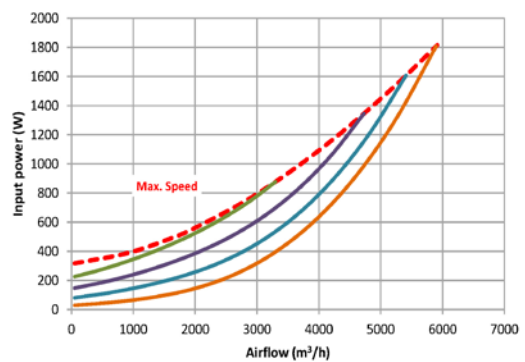
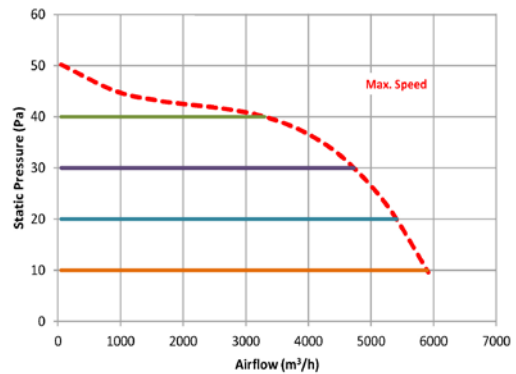

### Characteristic curves

Q= Flow rate in m<sup>3</sup>/h, m<sup>3</sup>/s and cfm

Pe= Static pressure in mm H<sub>2</sub>O, Pa and inwg

**CJBD/EC/CPC-2828-6M-1/3**

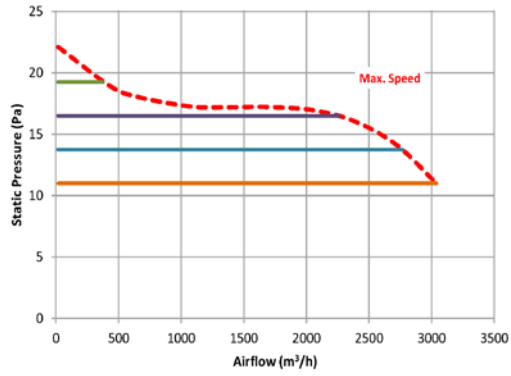

**CJBD/EC/CPC-3333-6M-1**

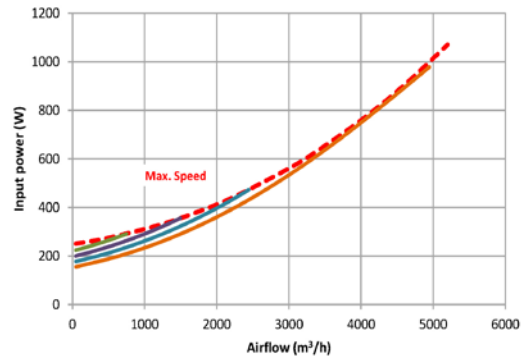
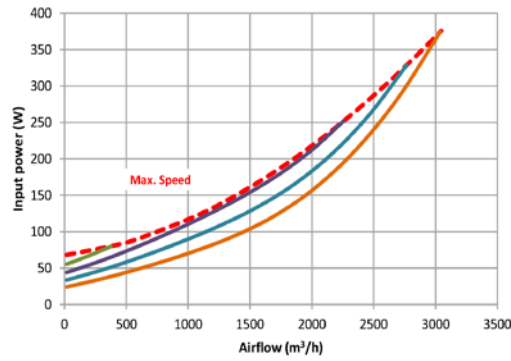
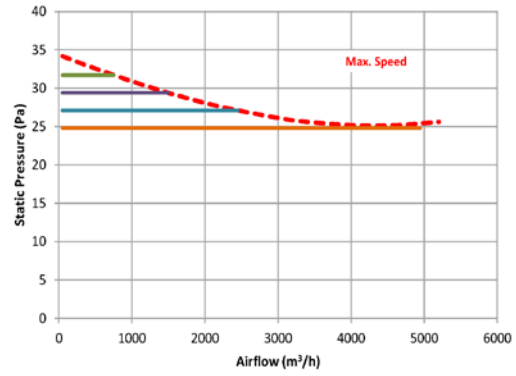



## Acoustic characteristics

The indicated values are determined by measuring the sound pressure level and sound power in dB(A) obtained in a free field at a distance equivalent to twice the size of the fan plus the impeller diameter, with a minimum of 1.5 m.

Sound power spectrum Lw(A) in dB(A) per Hz frequency band

	63	125	250	500	1000	2000	4000	8000
1919-4M-1/5 IE4	45	56	60	64	66	65	64	55
1919-6M-1/10 IE4	40	51	55	59	61	60	59	50
2525-4M-1/2 IE4	53	64	68	72	74	73	72	63
2525-4M-3/4 IE4	57	68	72	76	78	77	76	67
2525-4M-1 IE4	58	69	73	77	79	78	77	68
2525-6M-1/3 IE4	48	59	63	67	69	68	67	58
2828-4M-1 IE4	59	70	74	78	80	79	78	69
2828-4M-2 IE4	61	72	76	80	82	81	80	71
2828-6M-1/3 IE4	48	59	63	67	69	68	67	58
3333-6M-1 IE4	57	68	72	76	78	77	76	67

## Dimensions mm

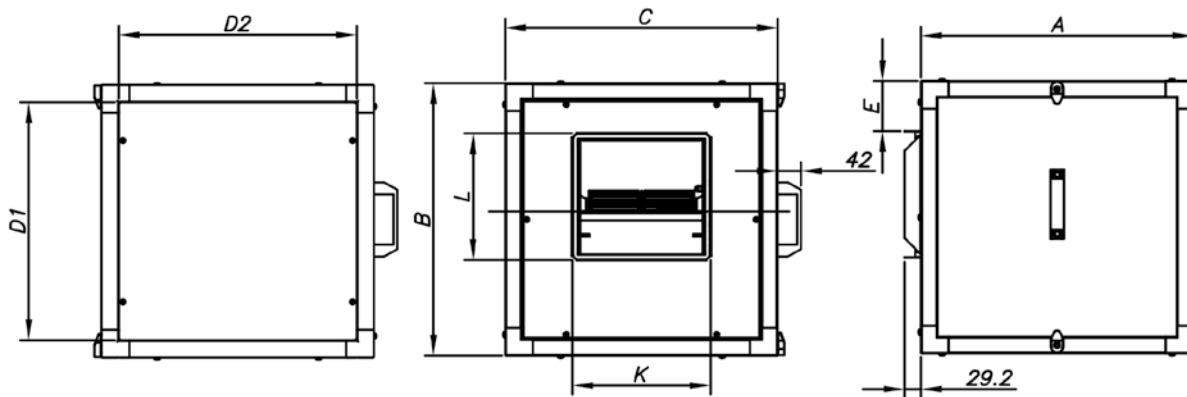

	Equivalence inches	A	B	C	D1	D2	E	L	K
CJBD/EC/AL-1919	7/7	490	490	490	428	428	91	226	247
CJBD/EC/AL-2525	9/9	550	550	550	488	488	86	279	317
CJBD/EC/AL-2828	10/10	605	605	605	543	543	88	306	343
CJBD/EC/AL-3333	12/12	680	680	680	618	618	84	360	404

## Characteristic curves

See series characteristic curves: CBD/EC

## Accessories







## Acoustic characteristics

The indicated values are determined by measuring the sound pressure level and sound power in dB(A) obtained in a free field at a distance equivalent to twice the size of the fan plus the impeller diameter, with a minimum of 1.5 m.

Sound power spectrum Lw(A) in dB(A) per Hz frequency band

	63	125	250	500	1000	2000	4000	8000
1919-4M-1/5 IE4	42	53	57	61	63	62	61	52
1919-6M-1/10 IE4	37	48	52	56	58	57	56	47
2525-4M-1/2 IE4	50	61	65	69	71	70	69	60
2525-4M-3/4 IE4	54	65	69	73	75	74	73	64
2525-4M-1 IE4	55	66	70	74	76	75	74	65
2525-6M-1/3 IE4	45	56	60	64	66	65	64	55
2828-4M-1 IE4	56	67	71	75	77	76	75	66
2828-4M-2 IE4	58	69	73	77	79	78	77	68
2828-6M-1/3 IE4	45	56	60	64	66	65	64	55
3333-6M-1 IE4	54	65	69	73	75	74	73	64

## Dimensions mm

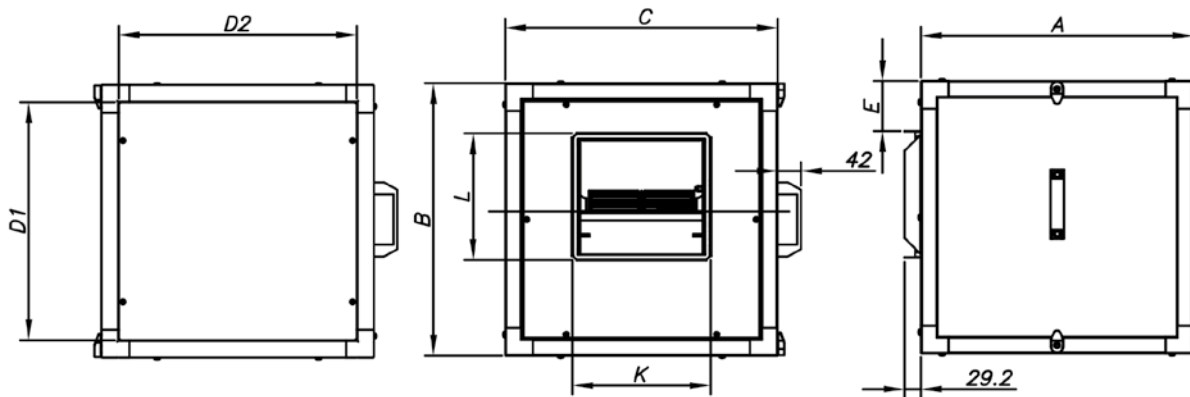

	Equivalence inches	A	B	C	D1	D2	E	L	K
CJBD/EC/ALS-1919	7/7	490	490	490	428	428	91	226	247
CJBD/EC/ALS-2525	9/9	550	550	550	488	488	86	279	317
CJBD/EC/ALS-2828	10/10	605	605	605	543	543	88	306	343
CJBD/EC/ALS-3333	12/12	680	680	680	618	618	84	360	404

## Characteristic curves

See series characteristic curves: CBD/EC

## Accessories



# CJBD/EC/C



Ventilation units with circular inlet and outlet and EC Technology IE4 motor with integrated electronics



Ventilation units with forward curved impeller and EC Technology IE4 motor with integrated electronics, specially designed to obtain high energy efficiency.

- Single-phase 190-250 V 50/60 Hz.
- Working temperature: -25 °C +60 °C.

**Fan:**

- Galvanized steel sheet casing.
- Forward curved impeller in galvanized sheet steel.

**Finish:**

- Anti-corrosive in galvanized steel sheet.

**Motor:**

- High efficiency EC Technology motors with integrated electronics, regulated by 0-10 V.
- IE4 efficiency motors, class F and IP54 protection.



With support foot to facilitate mounting.



EC TECHNOLOGY MOTOR with integrated electronics

## Order code

<b>CJBD/EC/C</b>	—	<b>2525</b>	—	<b>4M</b>	—	<b>3/4</b>	—	<b>IE4</b>
↓		↓		↓	↓	↓		↓
CJBD/EC/C: Ventilation units with circular inlet and outlet and EC Technology IE4 motor with integrated electronics		Impeller size mm mm    inch 1919   7/7 2525   9/9 2828   10/10 3333   12/12		Number of motor poles 4=1400 r/min 50 Hz 6=900 r/min 50 Hz	M = Single-phase	Motor power (HP)		IE4 motor

## Technical characteristics

Model	Equivalence inches	Max. speed (r/min)	Maximum admissible current (A)	Max. electric power (kW)	Maximum flow rate (m³/h)	Sound pressure level dB (A)	Approx. weight (Kg)	According ErP
			230V					
CJBD/EC/C-1919-4M-1/5 IE4	7/7	1400	1.65	0.18	1520	60	21	2018
CJBD/EC/C-1919-6M-1/10 IE4	7/7	900	0.98	0.09	1374	55	21	2018
CJBD/EC/C-2525-4M-1/2 IE4	9/9	1400	1.64	0.37	2400	68	24	2018
CJBD/EC/C-2525-4M-3/4 IE4	9/9	1400	2.37	0.55	3200	72	25	2018
CJBD/EC/C-2525-4M-1 IE4	9/9	1400	3.12	0.75	4200	73	26	2018
CJBD/EC/C-2525-6M-1/3 IE4	9/9	900	1.07	0.25	2785	63	25	2018
CJBD/EC/C-2828-4M-1 IE4	10/10	1400	4.12	0.75	3827	74	30	2018
CJBD/EC/C-2828-4M-2 IE4	10/10	1400	11.04	1.50	5915	76	32	2018
CJBD/EC/C-2828-6M-1/3 IE4	10/10	900	1.10	0.25	3046	63	31	2018
CJBD/EC/C-3333-6M-1 IE4	12/12	900	7.83	1.10	5200	72	45	2018



### Erp. (Energy Related Products)

Information on Directive 2009/125/EC can be downloaded from the SODECA website or the QuickFan selector programme.

## Acoustic characteristics

The indicated values are determined by measuring the sound pressure level and sound power in dB(A) obtained in a free field at a distance equivalent to twice the size of the fan plus the impeller diameter, with a minimum of 1.5 m.

Sound power spectrum Lw(A) in dB(A) per Hz frequency band

	63	125	250	500	1000	2000	4000	8000
1919-4M-1/5 IE4	45	56	60	64	66	65	64	55
1919-6M-1/10 IE4	40	51	55	59	61	60	59	50
2525-4M-1/2 IE4	53	64	68	72	74	73	72	63
2525-4M-3/4 IE4	57	68	72	76	78	77	76	67
2525-4M-1 IE4	58	69	73	77	79	78	77	68
2525-6M-1/3 IE4	48	59	63	67	69	68	67	58
2828-4M-1 IE4	59	70	74	78	80	79	78	69
2828-4M-2 IE4	61	72	76	80	82	81	80	71
2828-6M-1/3 IE4	48	59	63	67	69	68	67	58
3333-6M-1 IE4	57	68	72	76	78	77	76	67

## Dimensions mm

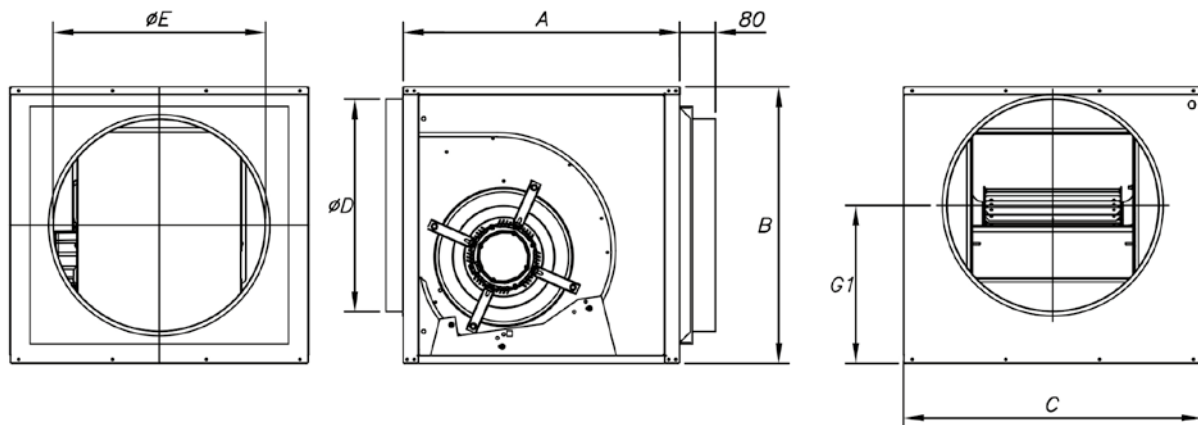

	Equivalence inches	A	B	C	øD	øE	G1
CJBD/EC/C-1919	7/7	450	460	500	250	250	245
CJBD/EC/C-2525	9/9	500	522	550	355	355	283.5
CJBD/EC/C-2828	10/10	550	575	600	400	400	324.5
CJBD/EC/C-3333	12/12	650	650	700	500	500	372.5

## Characteristic curves

See series characteristic curves: CBD/EC

## Accessories



# CMA/EC

Single inlet medium pressure centrifugal fans, casing and impeller in cast aluminum, and EC Technology IE5 motor



Medium pressure centrifugal fans, single inlet with casing and impeller in cast aluminum, with EC Technology IE5 motor with integrated electronics, specially designed for high energy efficiency.

#### Fan:

- Cast aluminium casing.
- Cast aluminium impeller.
- Maximum temperature of air to be carried: -25 °C +120 °C.
- Possibility of different outlet positions.

#### Motor:

- High efficiency EC Technology motors with integrated electronics, regulated by 0-10 V or 4-20 mA.
- IE5 efficiency motors, class F and IP55 protection.
- Single-phase 230 V 50/60 Hz.
- Working temperature: -25 °C +60 °C.

EC CONTROL: Supplied as an optional accessory. Control panel for ventilation systems with EC Technology motors with the electronics integrated in the motor itself. With the following characteristics:

- CPC: Constant pressure control.
- CFC: Constant flow control.
- DAY / NIGHT: Double pressure setpoint adjustment according to time of day.
- External sensor: compatible with temperature, humidity, air quality or CO sensor.
- Equipment preconfigured in constant pressure mode with 100 Pa set point.

#### Finish:

- Anti-corrosive finish in polyester resin, polymerised at 190 °C, after degreasing with phosphate-free nanotechnology treatment.



EC TECHNOLOGY MOTOR with integrated electronics



EC CONTROL Supplied as an optional accessory

## Order code

**CMA/EC – 426 – 2M – 0.5 – IE5**

CMA/EC: Single inlet medium pressure centrifugal fans, casing and impeller in cast aluminum, and EC Technology IE5 motor

Impeller size

Number of motor poles  
2=2900 r/min 50 Hz

M = Single-phase

Motor power (HP)

IE5 motor

## Technical characteristics

Model	Speed	Maximum admissible current (A)	Max. electric power	Maximum flow rate	Sound pressure level	Approx. weight	According ErP*
	(r/min)	230V	(kW)	(m <sup>3</sup> /h)	dB (A)	(Kg)	
CMA/EC-426-2M-0.5 IE5	2780	3.3	0.37	850	75	13	2020
CMA/EC-527-2M-0.75 IE5	2810	4.8	0.55	1000	80	15	2020
CMA/EC-528-2M-1 IE5	2810	5.9	0.75	1250	82	24	2020
CMA/EC-531-2M-1.5 IE5	2820	8.7	1.10	1790	84	29	2020

\* In accordance with the ErP 2020 draft



## Erp. (Energy Related Products)

Information on Directive 2009/125/EC can be downloaded from the SODECA website or the QuickFan selector programme.

### Acoustic characteristics

The indicated values are determined by measuring the sound pressure level and sound power in dB(A) obtained in a free field at a distance equivalent to twice the size of the fan plus the impeller diameter, with a minimum of 1.5 m.

Sound power spectrum Lw(A) in dB(A) per Hz frequency band

	63	125	250	500	1000	2000	4000	8000
CMA/EC-426-2M-0.5	41	55	73	79	83	80	75	66
CMA/EC-527-2M-0.75	46	60	78	84	88	85	80	71
CMA/EC-528-2M-1	48	62	80	86	90	87	82	73
CMA/EC-531-2M-1.5	51	65	83	89	93	90	85	76

### Dimensions mm

#### CMA/EC-426 ... 528

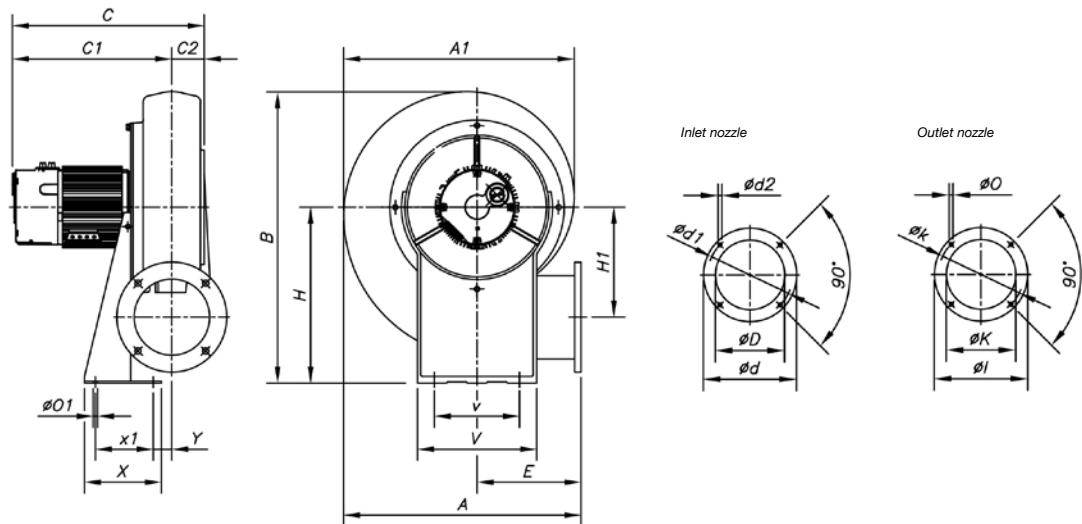

	A	A1	B	C	C1	C2	ØD	Ød	Ød1	Ød2	E	H	H1	ØI	ØK	Øk	ØO	ØO1	V	v	X	X1	Y
CMA/EC-426-2M	354	344	412	299	259	40	117	155	132	M6	162	240	163	140	90	119	7	13	210	160	105	65	26
CMA/EC-527-2M	371	361	440	319	277	42	125	170	147	M6	168	260	170	155	100	129	7	13	220	170	120	80	20
CMA/EC-528-2M	401	395	488	357	306	51	116	190	162	M6	178	290	177	190	130	160	11	13	230	180	140	100	20

#### CMA/EC-531

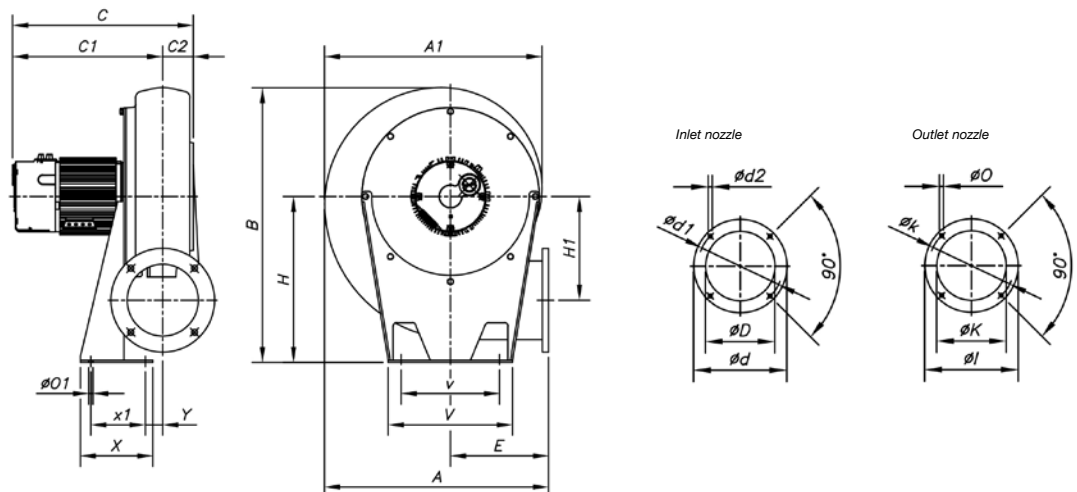

	A	A1	B	C	C1	C2	ØD	Ød	Ød1	Ød2	E	H	H1	ØI	ØK	Øk	ØO	ØO1	V	v	X	X1	Y
CMA/EC-531-2M	440	434	537	358	303	55	160	215	180	M6	193	320	200	200	140	175	11	13	226	190	160	120	21

### Characteristic curves

Q= Flow rate in m<sup>3</sup>/h, m<sup>3</sup>/s and cfm

Pe= Static pressure in mm H<sub>2</sub>O, Pa and inwg

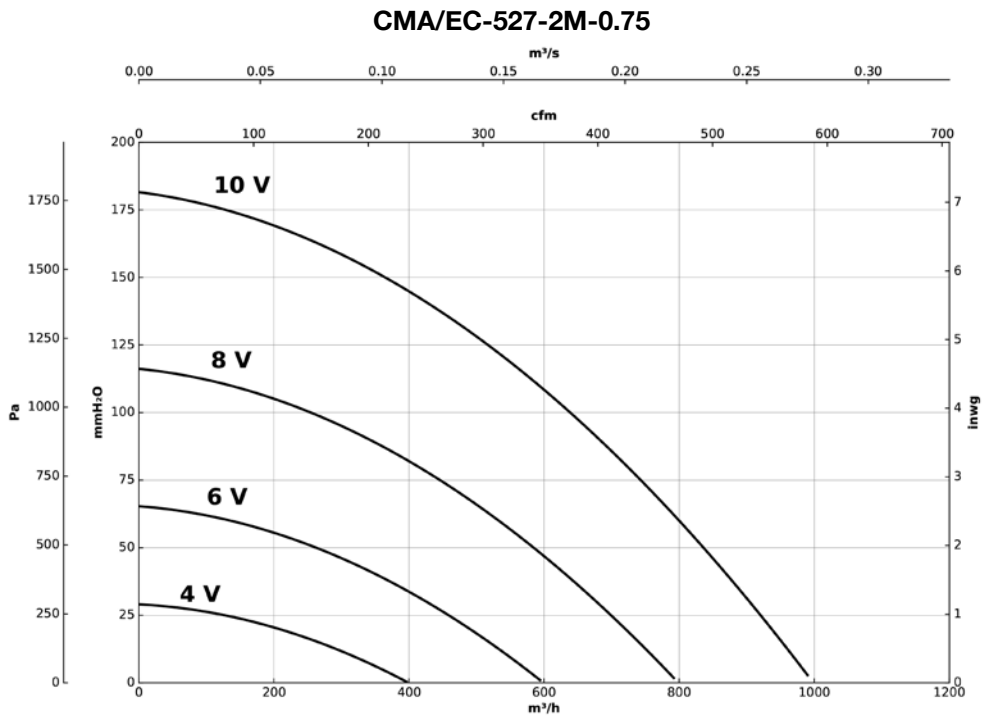
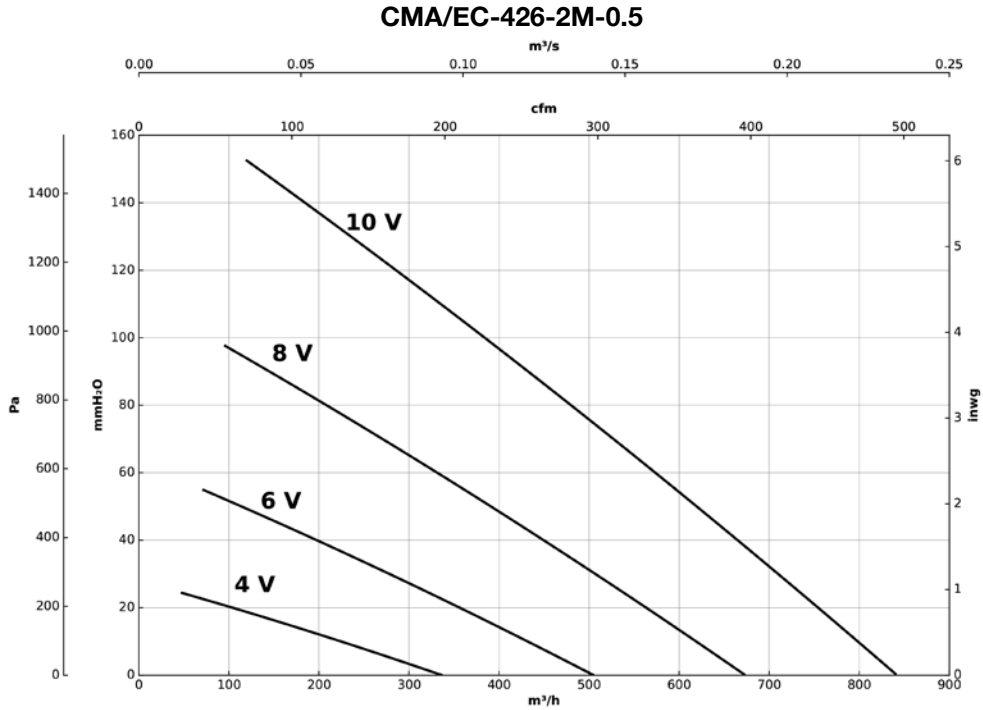

### Characteristic curves

Q= Flow rate in m<sup>3</sup>/h, m<sup>3</sup>/s and cfm

Pe= Static pressure in mm H<sub>2</sub>O, Pa and inwg

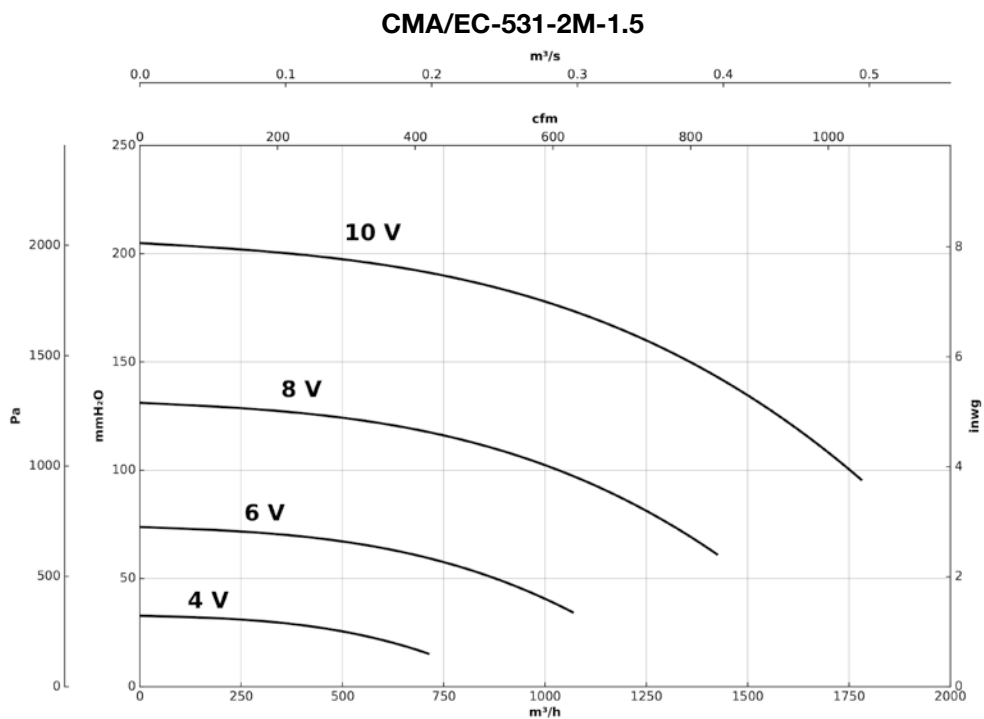
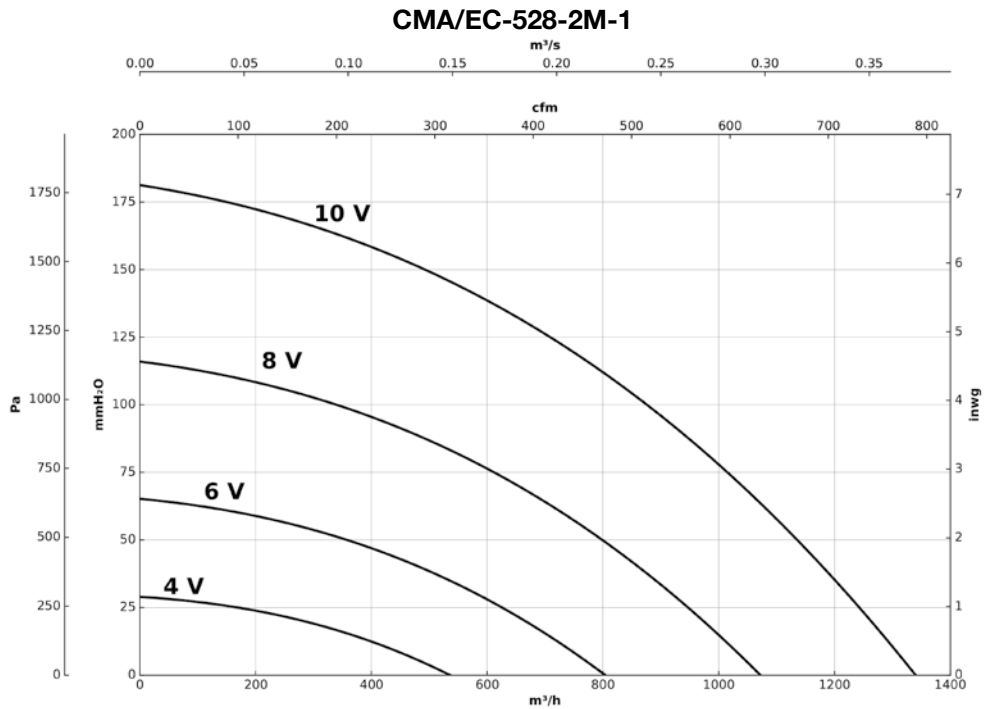

### Accessories



# CMP/EC

Single inlet medium pressure centrifugal fans, direct motor, forward curved impeller and EC Technology IE5 motor



EC TECHNOLOGY MOTOR with integrated electronics



EC CONTROL Supplied as an optional accessory

Medium pressure centrifugal fans and single inlet, with direct motor and forward curved impeller, with EC Technology IE5 motor with integrated electronics, specially designed for high energy efficiency.

#### Fan:

- Sheet steel casing.
- Forward curved impeller in extremely robust sheet steel.
- Maximum temperature of air to be carried: -25 °C +120 °C.

#### Motor:

- High efficiency EC Technology motors with integrated electronics, regulated by 0-10 V or 4-20 mA.
- IE5 efficiency motors, class F and IP55 protection.
- Single-phase 230 V 50/60 Hz.
- Working temperature: -25 °C +60 °C.

EC CONTROL: Supplied as an optional accessory. Control panel for ventilation

systems with EC Technology motors with the electronics integrated in the motor itself. With the following characteristics:

- CPC: Constant pressure control.
- CFC: Constant flow control.
- DAY / NIGHT: Double pressure setpoint adjustment according to time of day.
- External sensor: compatible with temperature, humidity, air quality or CO sensor.
- Equipment preconfigured in constant pressure mode with 100 Pa set point.

#### Finish:

- Anti-corrosive finish in polyester resin, polymerised at 190 °C, after degreasing with phosphate-free nanotechnology treatment.

#### On request:

- Fan prepared to transport air up to +250 °C.
- Stainless steel fan.

## Order code

**CMP/EC – 616 – 2M – 0.75 – IE5**

CMP/EC: Single inlet medium pressure centrifugal fans, direct motor, forward curved impeller and EC Technology IE5 motor

Impeller size

Number of motor poles  
2=2900 r/min 50 Hz  
4=1400 r/min 50 Hz

T = Three-phase  
M = Single-phase

Motor power (HP)

IE5 motor

## Technical characteristics

Model	Speed	Maximum admissible current (A) 230V	Max. electric power (kW)	Maximum flow rate (m <sup>3</sup> /h)	Sound pressure level dB (A)	Approx. weight (Kg)	According ErP*
	(r/min)						
CMP/EC-616-2M-0.75 IE5	2810	4.8	0.55	1380	69	10	2020
CMP/EC-620-2M-0.5 IE5	2780	3.3	0.37	765	68	10	2020
CMP/EC-718-2M-1 IE5	2810	5.9	0.75	1485	70	13	2020
CMP/EC-820-2M-1.5 IE5	2820	8.7	1.10	1950	73	16	2020
CMP/EC-820-4M-0.33 IE5	1370	2.3	0.25	1670	66	10	2020
CMP/EC-922-4M-0.75 IE5	1380	4.8	0.55	2450	66	19	2020
CMP/EC-1025-4M-1.5 IE5	1455	8.9	1.10	3400	70	43	2020

\* In accordance with the ErP 2020 draft





## Erp. (Energy Related Products)

Information on Directive 2009/125/EC can be downloaded from the SODECA website or the QuickFan selector programme.

### Acoustic characteristics

The indicated values are determined by measuring the sound pressure level and sound power in dB(A) obtained in a free field at a distance equivalent to twice the size of the fan plus the impeller diameter, with a minimum of 1.5 m.

Sound power spectrum Lw(A) in dB(A) per Hz frequency band

	63	125	250	500	1000	2000	4000	8000		63	125	250	500	1000	2000	4000	8000
CMP/EC-616-2M-0.75	44	54	65	72	76	73	71	64	CMP/EC-820-4M-0.33	41	51	62	69	73	70	68	61
CMP/EC-620-2M-0.5	43	53	64	71	75	72	70	63	CMP/EC-922-4M-0.75	40	52	62	70	72	71	68	60
CMP/EC-718-2M-1	45	55	66	73	77	74	72	65	CMP/EC-1025-4M-1.5	45	54	65	72	76	73	72	65
CMP/EC-820-2M-1.5	48	58	69	76	80	77	75	68									

### Dimensions mm

#### CMP/EC-616 ... 820

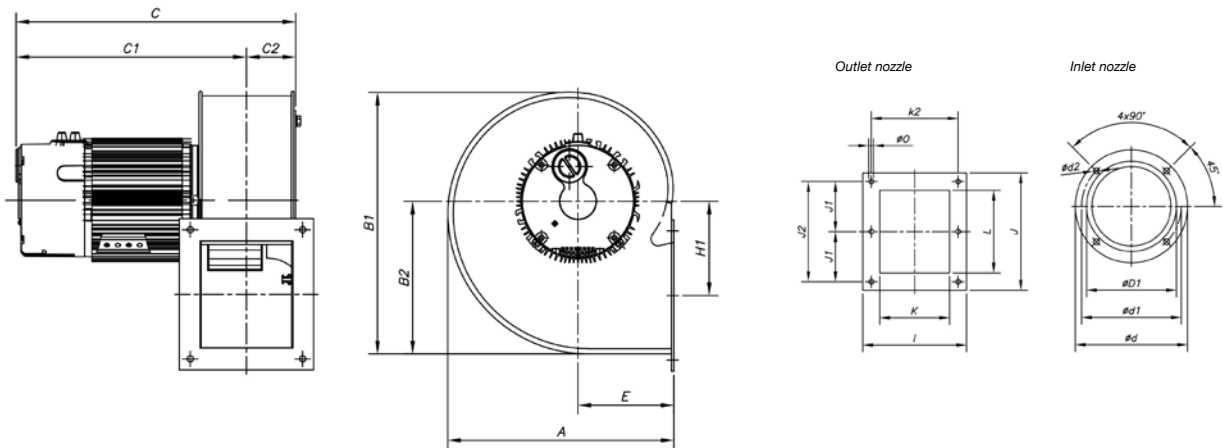

	A	B1	B2	C	C1	C2	ØD1	Ød	Ød1	Ød2	E	H1	I	J	J1	J2	K	k2	L	ØO
CMP/EC-616-2M	258	297	173.5	332	276	56	160	204	180	M6	110	105.5	153	172	-	147	103	128	122	7
CMP/EC-620-2M	298	347	202.5	316	260	56	200	247	230	M6	126	145.5	159	153	-	128	105	134	100	8
CMP/EC-718-2M	303.5	348	201	368	307	61	180	238	210	M6	129.5	122	169	192	85	170	115	145	146	9
CMP/EC-820-2M	322	377	223	383	314.5	68.5	200	247	230	M6	137.5	137	184	213	94.5	189	130	160	156	9
CMP/EC-820-4M	322	377	223	341	272.5	68.5	200	247	230	M6	137.5	137	184	213	94.5	189	130	160	156	9

#### CMP/EC-922 ... 1025

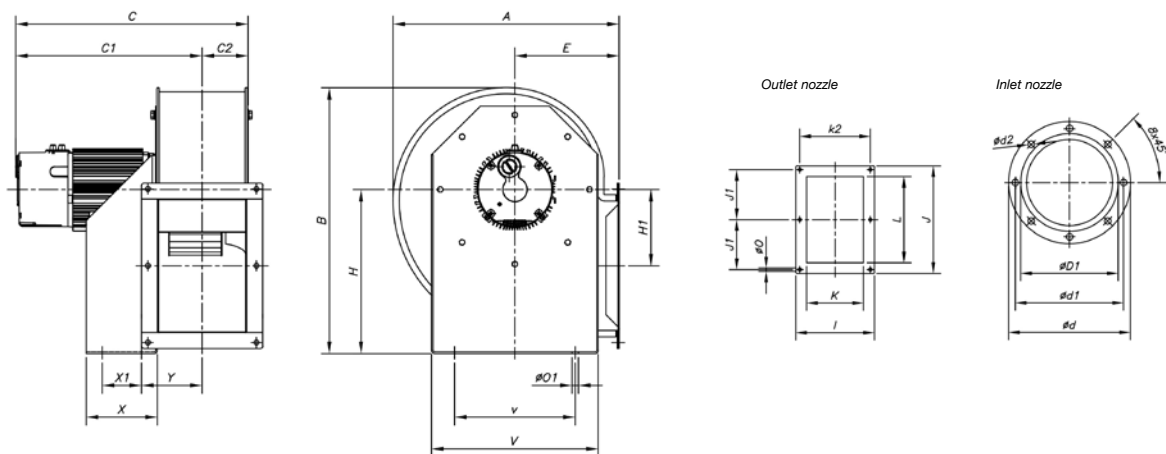

	A	B	C	C1	C2	ØD1	Ød	Ød1	Ød2	E	H	H1	I	J	J1	K	k2	L	ØO	ØO1	V	v	X	X1	Y
CMP/EC-922-4M	388.5	455	416.5	343	73.5	224	278	256	M8	180	280	134	204	282.5	128	140	180	215	9.5	10.5	290	220	114	50	105
CMP/EC-1025-4M	427	503	440.5	354.5	86	250	305	282	M8	197	310	144	229	312.5	145	165	205	250	9.5	12.5	315	228	134	74	115.5

## Characteristic curves

Q= Flow rate in m<sup>3</sup>/h, m<sup>3</sup>/s and cfm

Pe= Static pressure in mm H<sub>2</sub>O, Pa and inwg

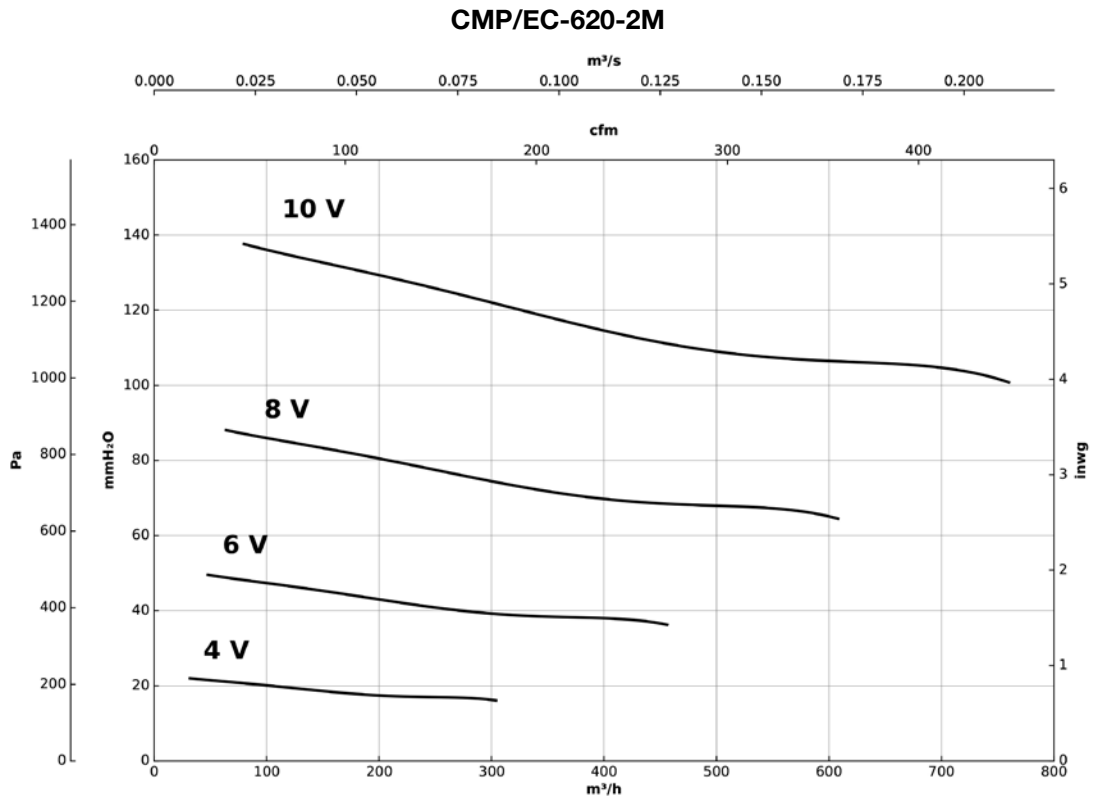
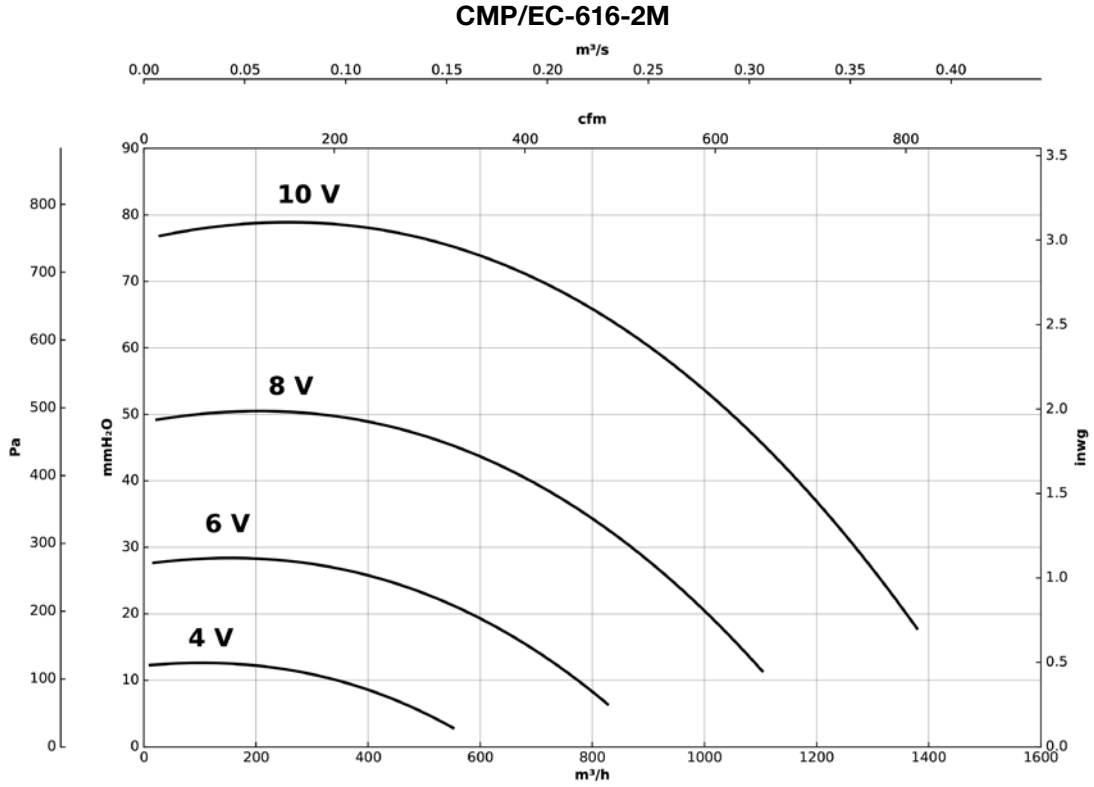

### Characteristic curves

Q= Flow rate in m<sup>3</sup>/h, m<sup>3</sup>/s and cfm

Pe= Static pressure in mm H<sub>2</sub>O, Pa and inwg

#### CMP/EC-718-2M

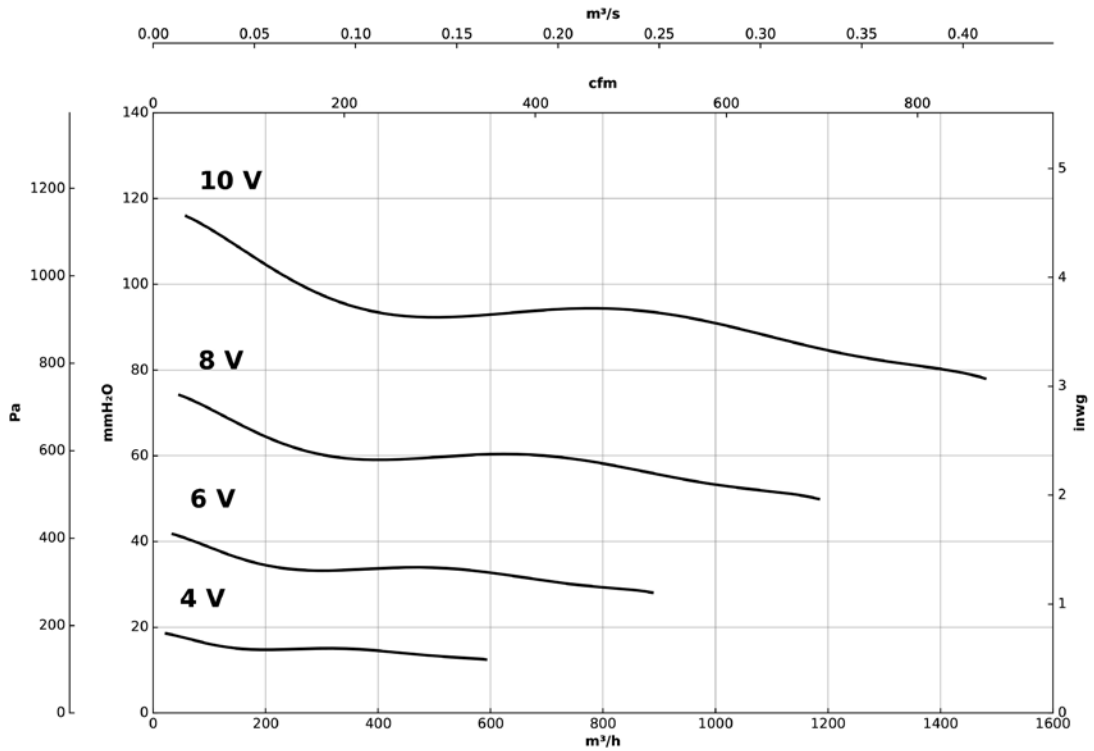

#### CMP/EC-820-2M

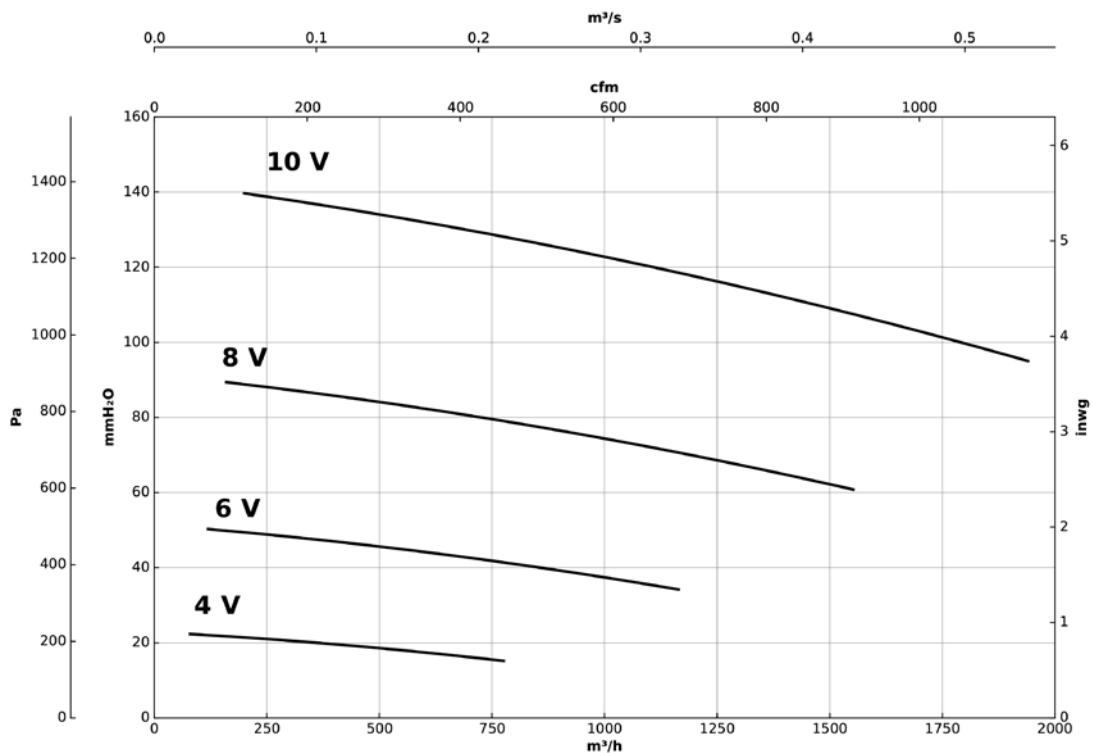

## Characteristic curves

Q= Flow rate in m<sup>3</sup>/h, m<sup>3</sup>/s and cfm

Pe= Static pressure in mm H<sub>2</sub>O, Pa and inwg

### CMP/EC-820-4M

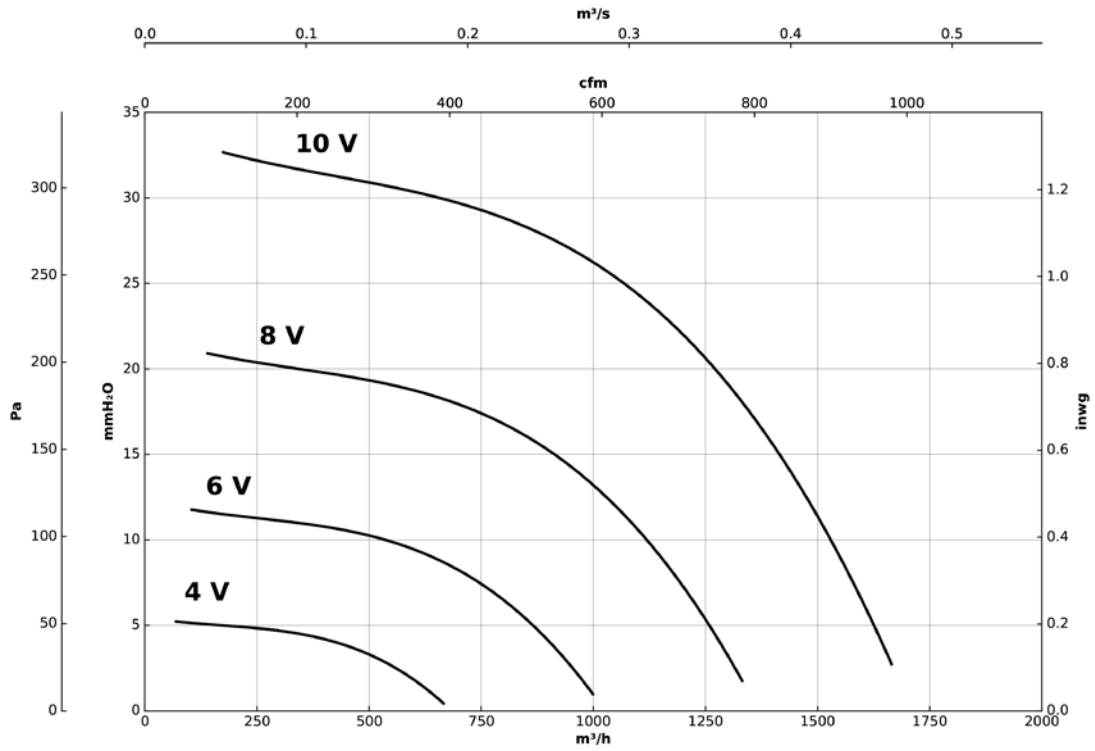

### CMP/EC-922-4M

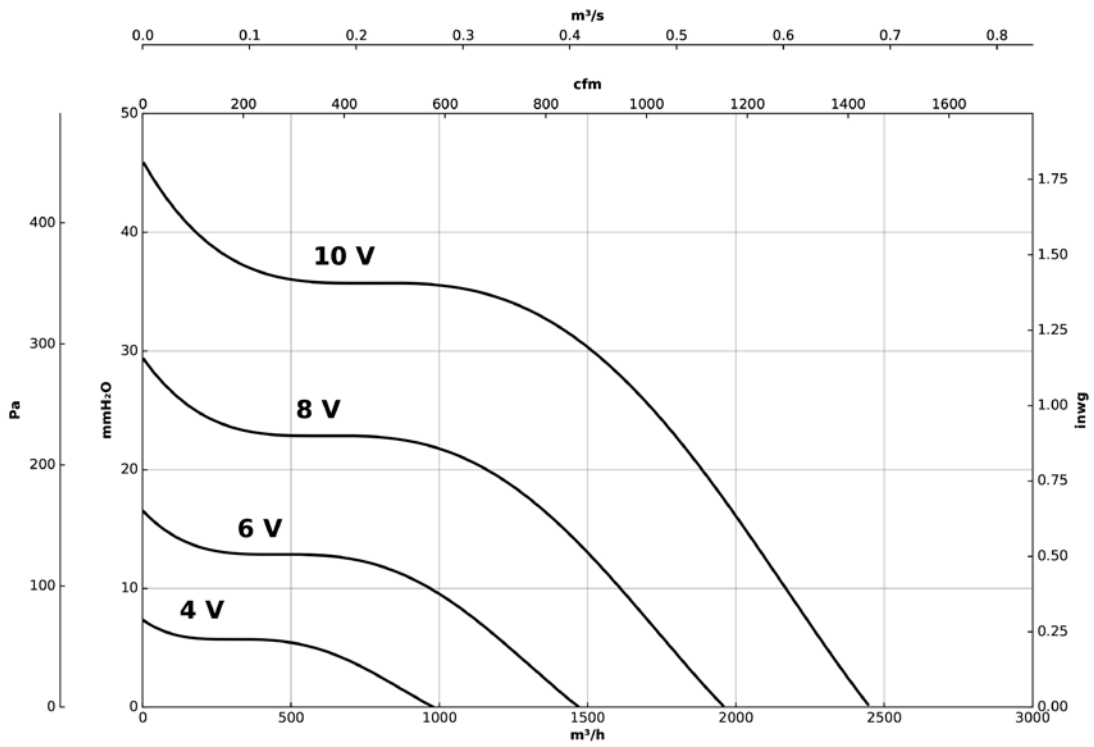

## Characteristic curves

Q= Flow rate in m<sup>3</sup>/h, m<sup>3</sup>/s and cfm

Pe= Static pressure in mm H<sub>2</sub>O, Pa and inwg

### CMP/EC-1025-4M

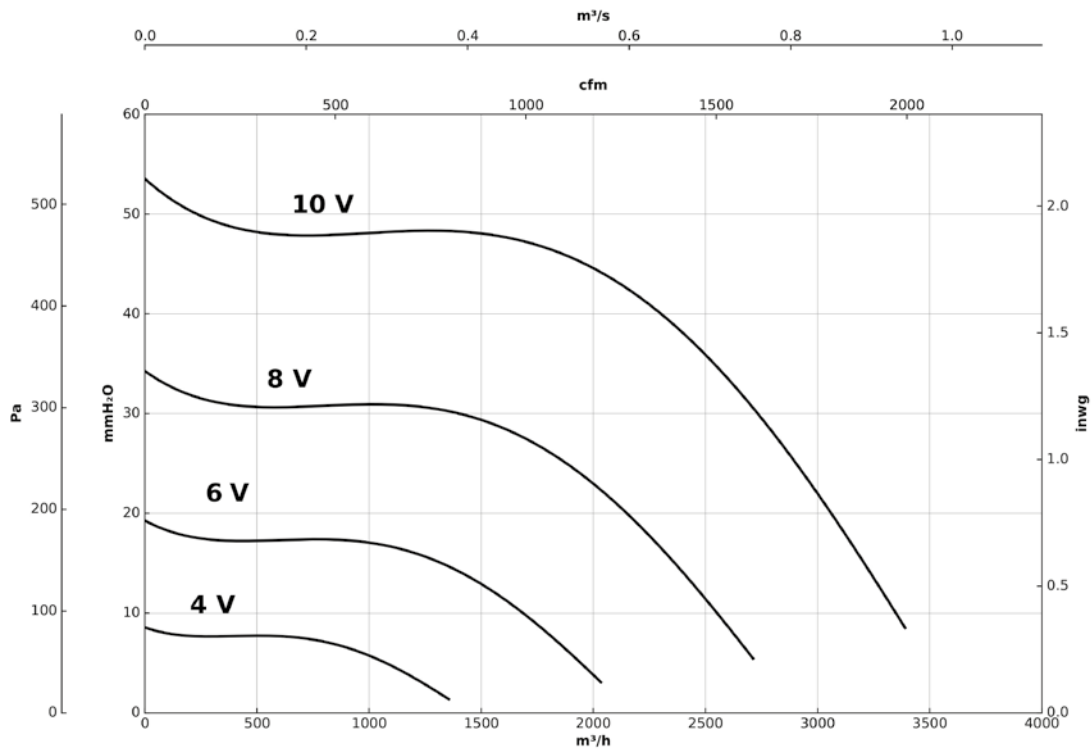

## Accessories



# CRL/EC

Single inlet medium pressure centrifugal fans, backward curved impeller, IE5 EC Technology direct motor



← EC TECHNOLOGY MOTOR with integrated electronics



← EC CONTROL Supplied as an optional accessory

Medium pressure centrifugal fans and single inlet, with direct motor and backward curved impeller, with EC Technology IE5 motor with integrated electronics, specially designed for high energy efficiency.

**Fan:**

- Sheet steel casing.
- Backward curved impeller made of sheet steel.
- Maximum temperature of air to be carried: -25 °C +120 °C.

**Motor:**

- High efficiency EC Technology motors with integrated electronics, regulated by 0-10 V or 4-20 mA.
- IE5 efficiency motors, class F and IP55 protection.
- Single-phase 230 V 50/60 Hz.
- Working temperature: -25 °C +60 °C.

EC CONTROL: Supplied as an optional accessory. Control panel for ventilation

systems with EC Technology motors with the electronics integrated in the motor itself. With the following characteristics:

- CPC: Constant pressure control.
- CFC: Constant flow control.
- DAY / NIGHT: Double pressure setpoint adjustment according to time of day.
- External sensor: compatible with temperature, humidity, air quality or CO sensor.
- Equipment preconfigured in constant pressure mode with 100 Pa set point.

**Finish:**

- Anti-corrosive finish in polyester resin, polymerised at 190 °C, after degreasing with phosphate-free nanotechnology treatment.

**On request:**

- Fan prepared to transport air up to +250 °C.
- Stainless steel fan.

## Order code

**CRL/EC – 925 – 2M – 0.5 – IE5**

CRL/EC: Single inlet medium pressure centrifugal fans, backward curved impeller, IE5 EC Technology direct motor

Impeller size

Number of motor poles  
2=2900 r/min 50 Hz  
4=1400 r/min 50 Hz

T = Three-phase  
M = Single-phase

Motor power (HP)

IE5 motor

## Technical characteristics

Model	Speed (r/min)	Maximum admissible current (A)	Max. electric power	Maximum flow rate (m³/h)	Sound pressure level dB (A)	Approx. weight (Kg)	According ErP*
		230V	(kW)				
CRL/EC-822-2M-0.33 IE5	2760	2.4	0.25	1350	72	19	2020
CRL/EC-925-2M-0.5 IE5	2830	3.3	0.37	1850	75	22	2020
CRL/EC-1028-2M-0.75 IE5	2780	4.8	0.55	2600	77	29	2020
CRL/EC-1031-2M-1.5 IE5	2830	8.7	1.10	3600	82	41	2020
CRL/EC-1240-4M-1 IE5	1420	5.8	0.75	3630	74	66	2020
CRL/EC-1445-4M-1.5 IE5	1455	8.9	1.10	6170	78	83	2020

\* In accordance with the ErP 2020 draft



## Erp. (Energy Related Products)

Information on Directive 2009/125/EC can be downloaded from the SODECA website or the QuickFan selector programme.

## Acoustic characteristics

The indicated values are determined by measuring the sound pressure level and sound power in dB(A) obtained in a free field at a distance equivalent to twice the size of the fan plus the impeller diameter, with a minimum of 1.5 m.

Sound power spectrum Lw(A) in dB(A) per Hz frequency band

	63	125	250	500	1000	2000	4000	8000
CRL/EC-822-2M-0.33	54	67	67	80	75	75	75	68
CRL/EC-925-2M-0.5	58	71	71	84	79	79	79	72
CRL/EC-1028-2M-0.75	59	72	72	85	80	80	80	79
CRL/EC-1031-2M-1.5	65	78	78	91	86	86	86	79
CRL/EC-1240-4M-1	57	71	77	80	80	81	71	60
CRL/EC-1445-4M-1.5	60	73	79	84	81	84	79	69

## Orientations

Standard supply LG 270  
Positions LG 180 and RD 180 on request with special anchoring measurements.  
Models 822, 925, 1028 and 1031 do not admit positions LG 135 or RD 135.

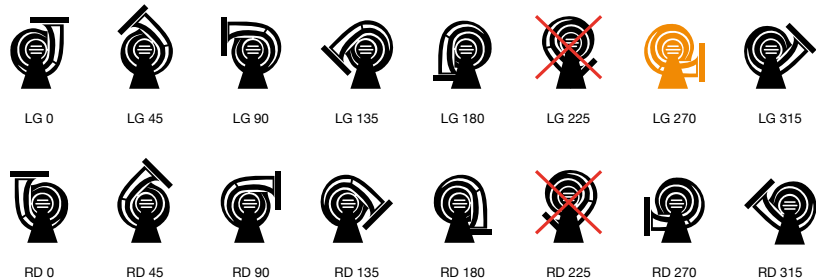

## Accessories

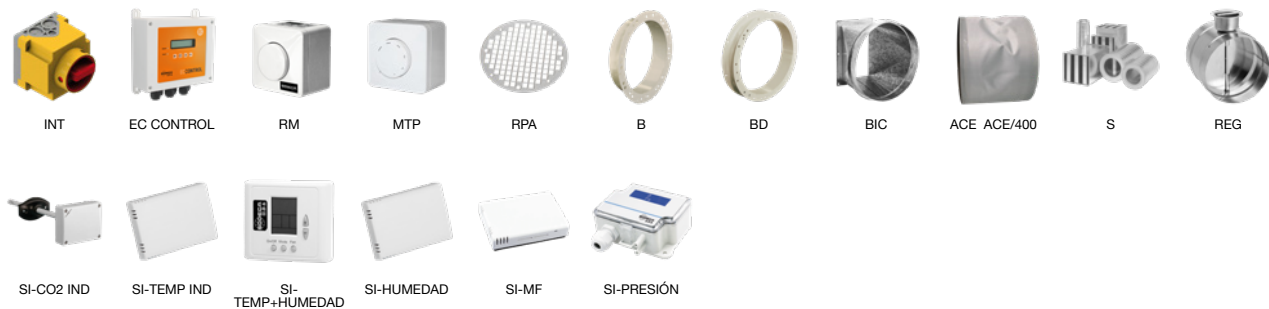

## Dimensions mm

### CRL/EC-822 ... 1028

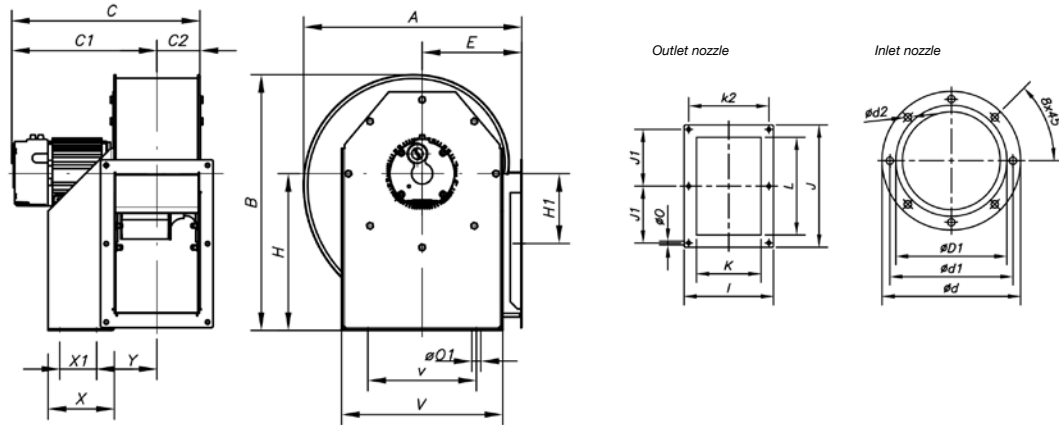

	A	B	C	C1	C2	ØD1*	Ød	Ød1	Ød2	E	H	H1	I	J	J1	K	K2	L	ØO	ØO1	V	v	X	X1	Y
CRL/EC-822-2M	388	455	353	280	73	224	278	256	M8	180	280	134	204	282.5	128	140	180	215	9.5	10.5	290	220	114	50	105
CRL/EC-925-2M	427	500	380	295	85	250	305	282	M8	197	310	145	229	312.5	145	165	205	250	9.5	12.5	315	228	134	74	115
CRL/EC-1028-2M	472	550	411	317.5	93.5	280	348	320	M8	215	340	152	244	364	170	180	220	296.5	9.5	12.5	350	245	144	95	120

\* Recommended nominal tube diameter

### CRL/EC-1031 ... 1445

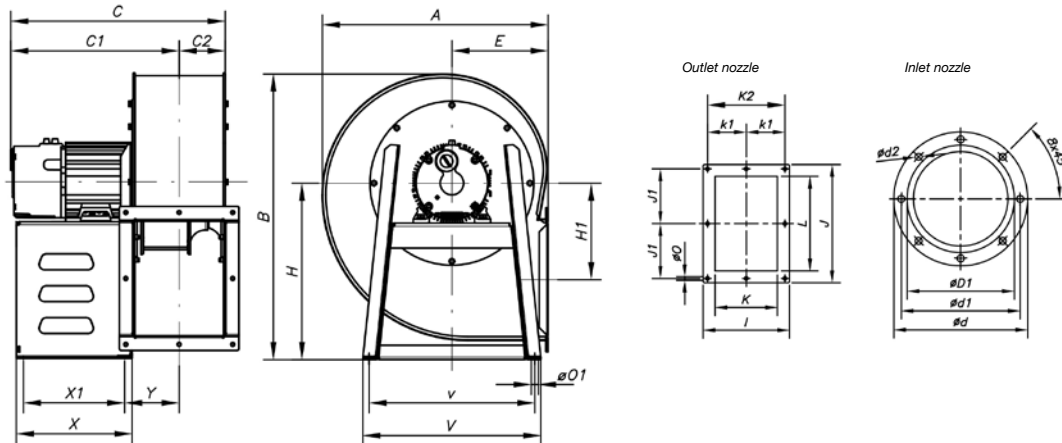

	A	B	C	C1	C2	ØD1*	Ød	Ød1	Ød2	E	H	H1	I	J	J1	K	K1	L	ØO	ØO1	V	v	X	X1	Y	K2
CRL/EC-1031-2M	526	630	456	352.5	103.5	315	382	354	M8	238	390	180	264	382.5	180	200	--	320	11.5	12	430	400	200	155	130	240
CRL/EC-1240-4M	635	800	528	398.5	129.5	400	464	438	M8	270	495	270	336	404	185	250	150	321	11.5	12	500	460	250	200	157	-
CRL/EC-1445-4M	710	900	566	419.5	146.5	450	515	485	M8	300	560	305	370	444	202	284	164	361	11.5	12	575	550	275	215	180	-

\* Recommended nominal tube diameter



### Characteristic curves

Q= Flow rate in m<sup>3</sup>/h, m<sup>3</sup>/s and cfm

Pe= Static pressure in mm H<sub>2</sub>O, Pa and inwg

**CRL/EC-822-2M-0.33**

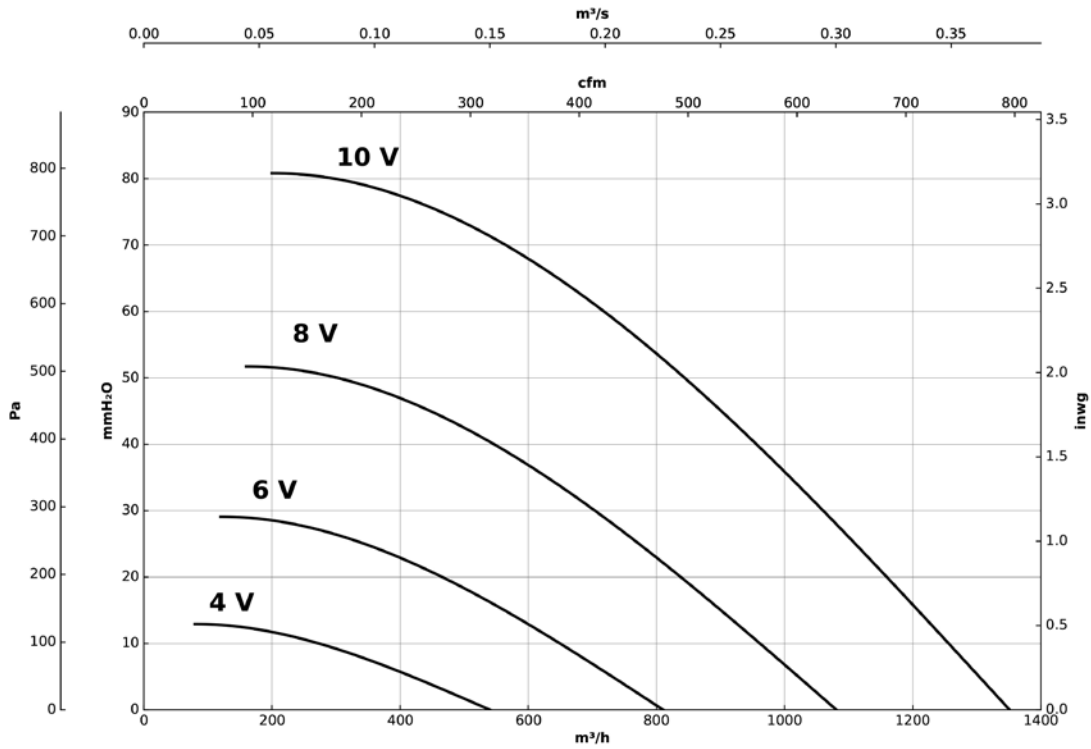

**CRL/EC-925-2M-0.5**

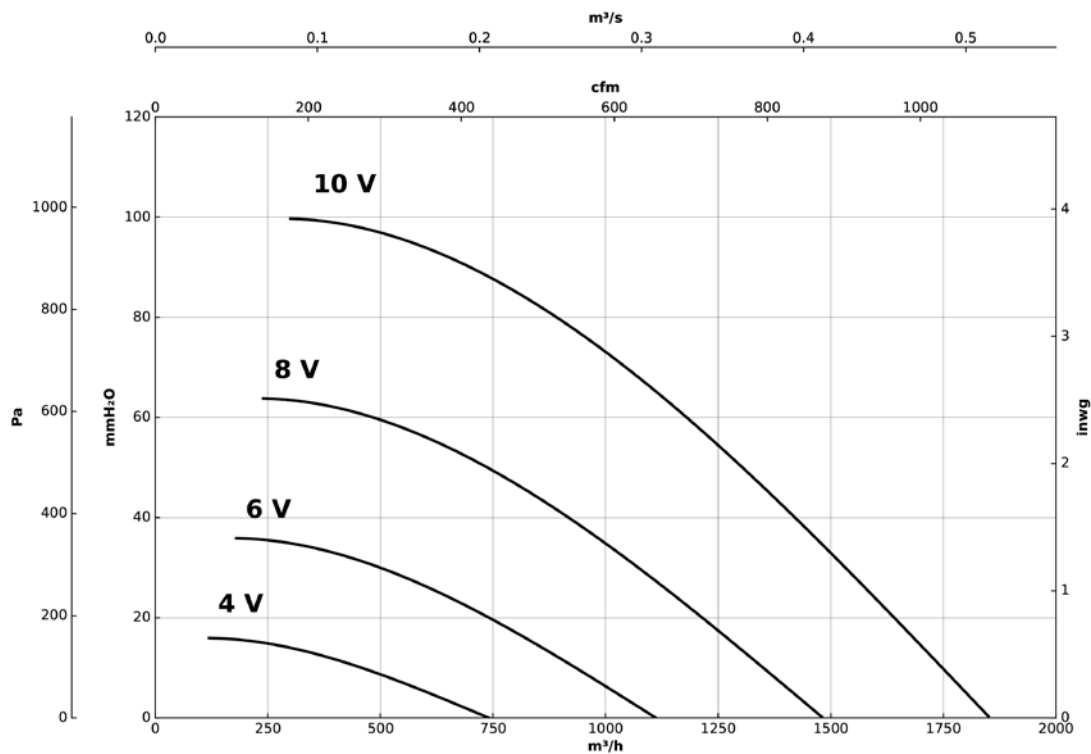

### Characteristic curves

Q= Flow rate in m<sup>3</sup>/h, m<sup>3</sup>/s and cfm

Pe= Static pressure in mm H<sub>2</sub>O, Pa and inwg

**CRL/EC-1028-2M-0.75**

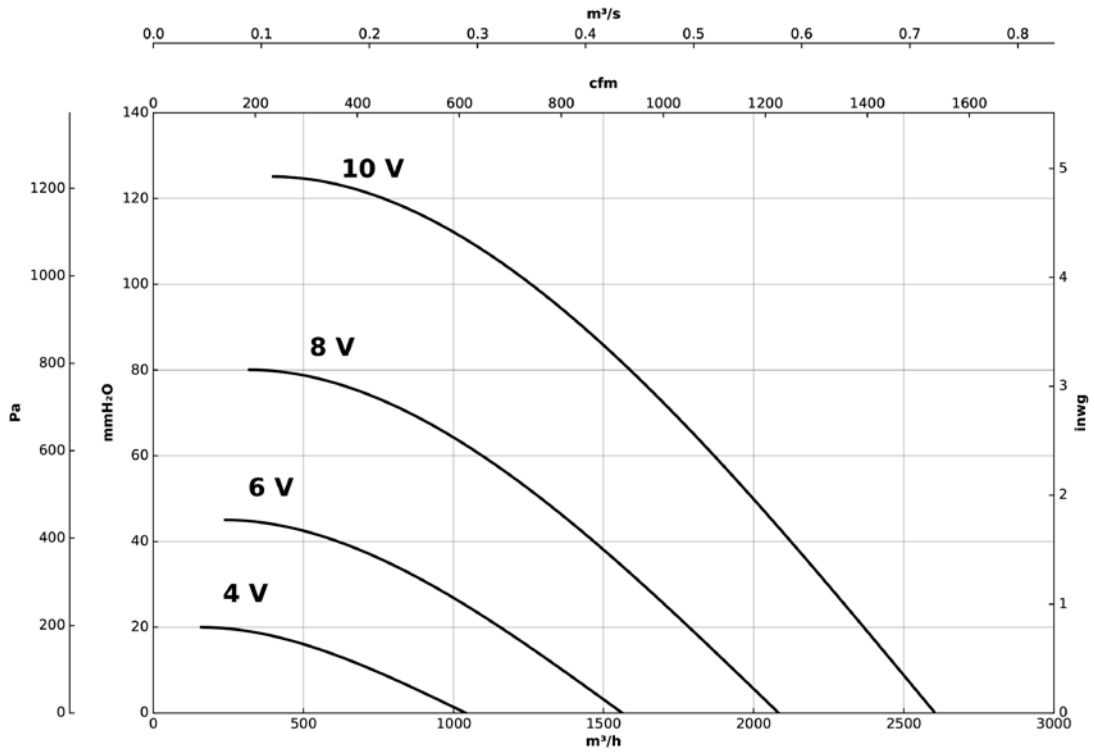

**CRL/EC-1031-2M-1.5**

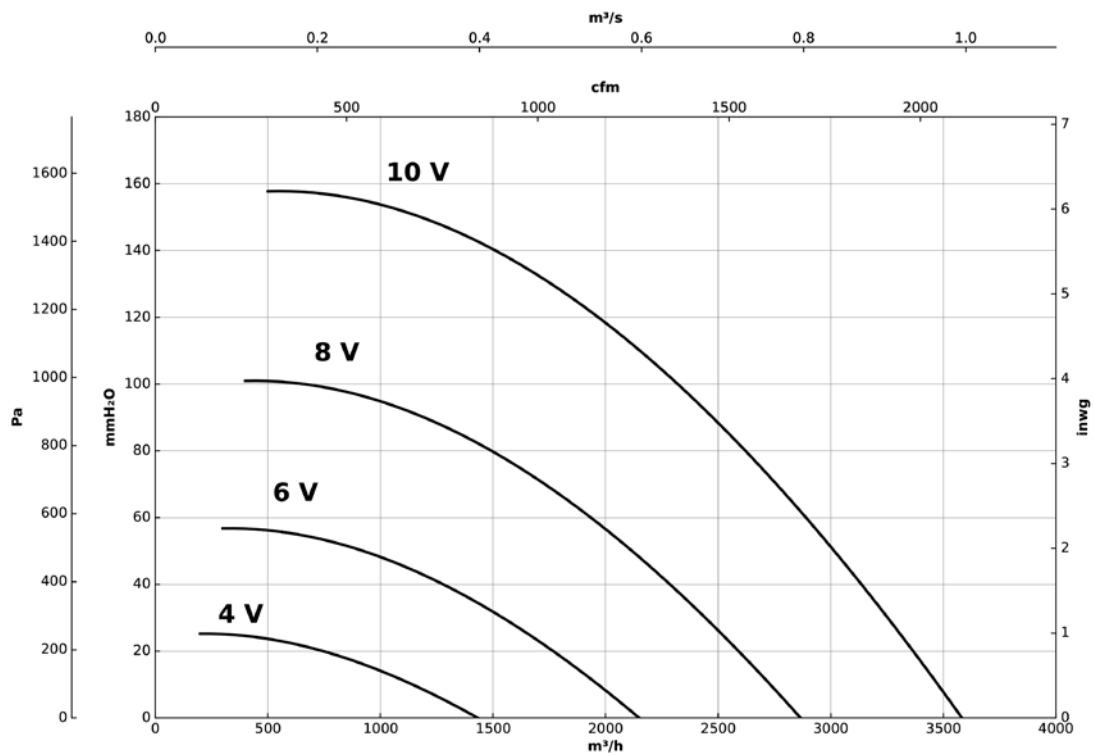

### Characteristic curves

Q= Flow rate in m<sup>3</sup>/h, m<sup>3</sup>/s and cfm

Pe= Static pressure in mm H<sub>2</sub>O, Pa and inwg

**CRL/EC-1240-4M-1**

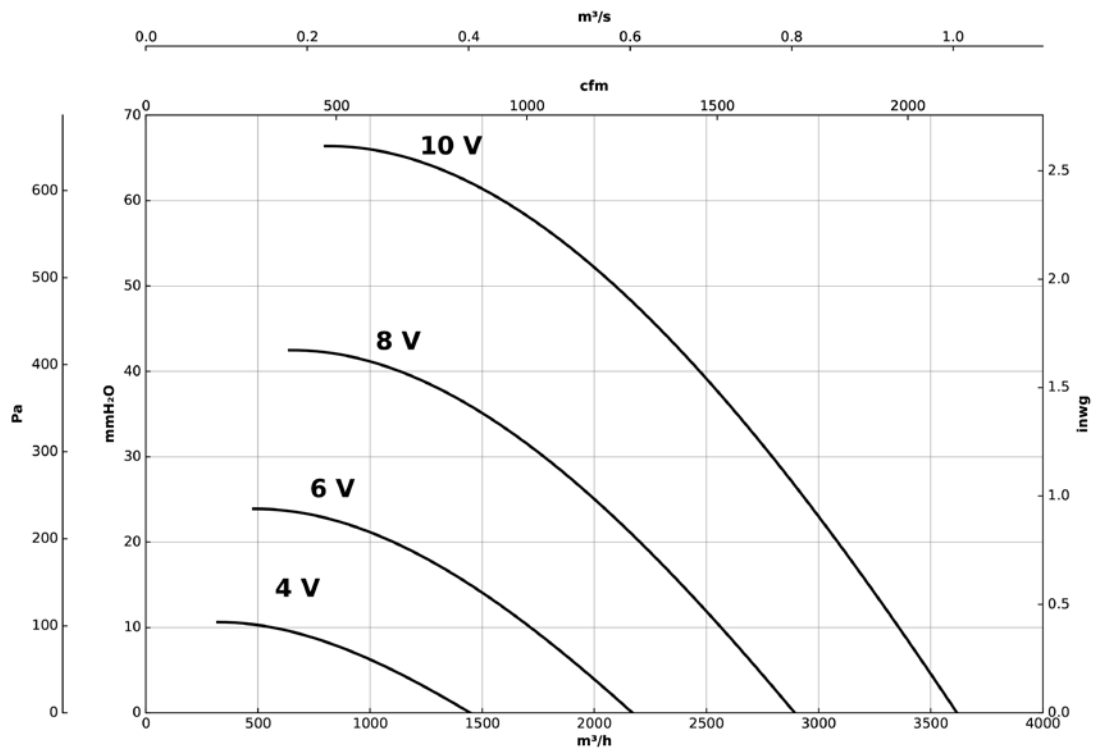

**CRL/EC-1445-4M-1.5**

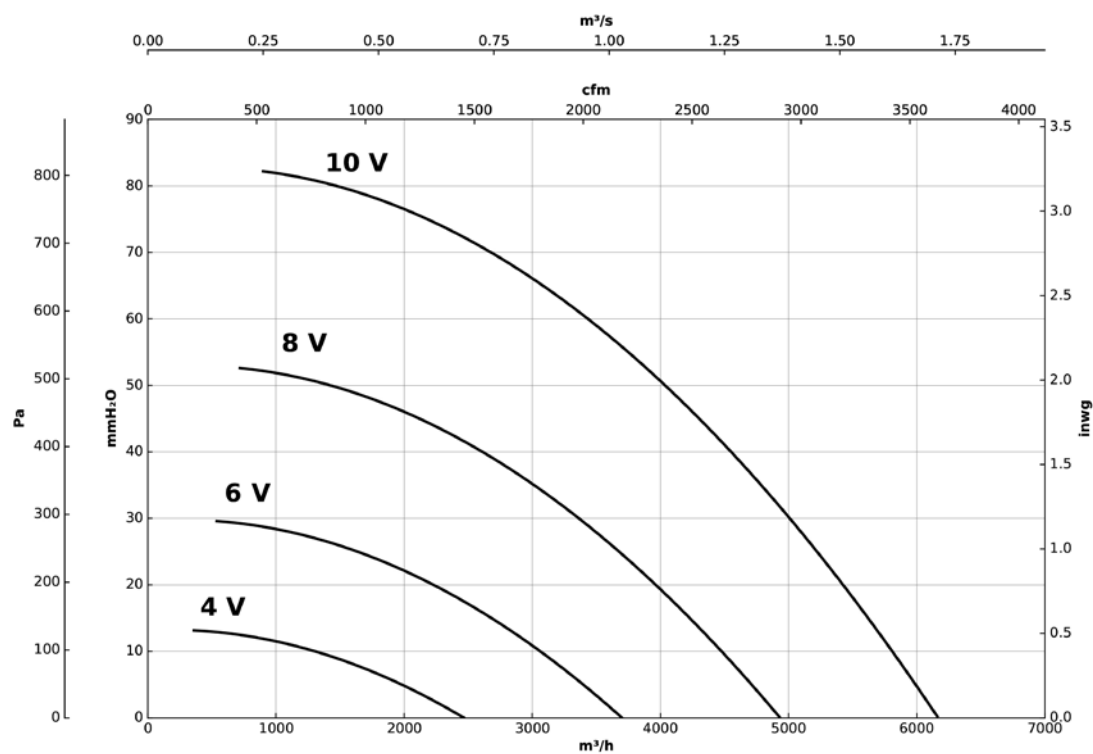

# CPV/EC

Single inlet anti-corrosive centrifugal fans made of polypropylene, with EC Technology IE5 motor



EC TECHNOLOGY MOTOR with integrated electronics



EC CONTROL Supplied as an optional accessory

Single inlet anti-corrosive centrifugal fans made of polypropylene, equipped with EC Technology IE5 motor with integrated electronics, specially designed for high energy efficiency.

#### Fan:

- Polypropylene casing.
- Forward curved impeller in polypropylene.
- Maximum temperature of air to be carried: -25 °C +70 °C.

#### Motor:

- High efficiency EC Technology motors with integrated electronics, regulated by 0-10 V or 4-20 mA.
- IE5 efficiency motors, class F and IP55 protection.
- Single-phase 230 V 50/60 Hz.
- Working temperature: -25 °C +60 °C.

EC CONTROL: Supplied as an optional accessory. Control panel for ventilation systems with EC Technology motors with the electronics integrated in the motor itself. With the following characteristics:

- CPC: Constant pressure control.
- CFC: Constant flow control.
- DAY / NIGHT: Double pressure setpoint adjustment according to time of day.
- External sensor: compatible with temperature, humidity, air quality or CO sensor.
- Equipment preconfigured in constant pressure mode with 100 Pa set point.

#### Finish:

- Anti-corrosive in plastic material.

## Order code

**CPV/EC – 825 – 2M – 1.5 – IE5**

CPV/EC: Single inlet anti-corrosive centrifugal fans made of polypropylene, with EC Technology IE5 motor

Impeller size

Number of motor poles  
 2=2900 r/min 50 Hz  
 4=1400 r/min 50 Hz  
 6=900 r/min 50 Hz

T = Three-phase  
 M = Single-phase

Motor power (HP)

IE5 motor

## Technical characteristics

Model	Speed	Maximum admissible current (A) 230V	Max. electric power (kW)	Maximum flow rate (m³/h)	Sound pressure level (dB (A))	Approx. weight (Kg)	According ErP*
	(r/min)						
CPV/EC-825-2M-1.5 IE5	2830	8.7	1.10	1140	79	18	2020
CPV/EC-1020-2M-1 IE5	2825	5.9	0.75	2000	81	25	2020
CPV/EC-1020-4M-0.33 IE5	1350	2.3	0.25	1250	65	20	2020
CPV/EC-1325-4M-0.5 IE5	1370	3.4	0.37	2300	69	27	2020
CPV/EC-1630-6M-1 IE5	900	5.9	0.75	2700	63	35	2020

\* In accordance with the ErP 2020 draft



## Erp. (Energy Related Products)

Information on Directive 2009/125/EC can be downloaded from the SODECA website or the QuickFan selector programme.

### Acoustic characteristics

The indicated values are determined by measuring the sound pressure level and sound power in dB(A) obtained in a free field at a distance equivalent to twice the size of the fan plus the impeller diameter, with a minimum of 1.5 m.

Sound power spectrum Lw(A) in dB(A) per Hz frequency band

	63	125	250	500	1000	2000	4000	8000
CPV/EC-825-2M-1.5	60	73	81	85	85	81	77	69
CPV/EC-1020-2M-1	62	75	83	87	87	83	79	71
CPV/EC-1020-4M-0.33	46	59	67	71	71	67	63	55
CPV/EC-1325-4M-0.5	52	65	73	77	78	74	70	61
CPV/EC-1630-6M-1	48	61	69	73	74	70	66	57

### Dimensions mm

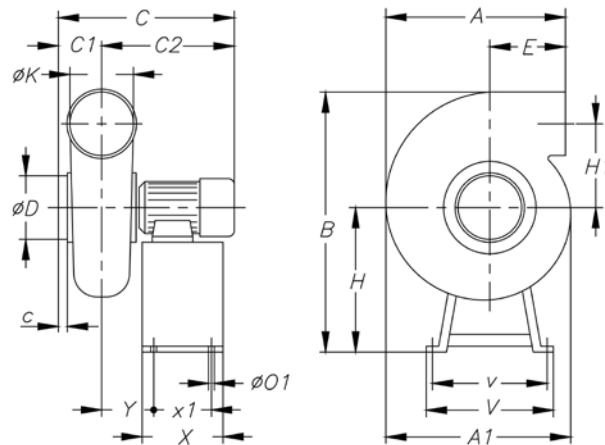

	A	A1	B	C	C1	C2	c	øD	E	H	H1	øK	øO1	V	v	X	x1	Y
CPV/EC-825-2M	445	-	552	454	110	344	55	125	218	320	170	125	6	340	320	180	160	103
CPV/EC-1020-2M	340	397	593	458.5	116	342.5	32	160	100	290	223	160	8	355	335	180	160	127.5
CPV/EC-1020-4M	340	397	584	418.5	116	302.5	32	160	100	281	223	160	8	355	335	180	160	122.5
CPV/EC-1325-4M	413	505	716	460	130	330	35	200	103	351	265	200	8	400	380	180	160	113.5
CPV/EC-1630-6M	480	602	880	538	145	393	35	250	117	430	323	250	8	450	430	240	220	138

## Characteristic curves

Q= Flow rate in m<sup>3</sup>/h, m<sup>3</sup>/s and cfm

Pe= Static pressure in mm H<sub>2</sub>O, Pa and inwg

### CPV/EC-825-2M-1.5

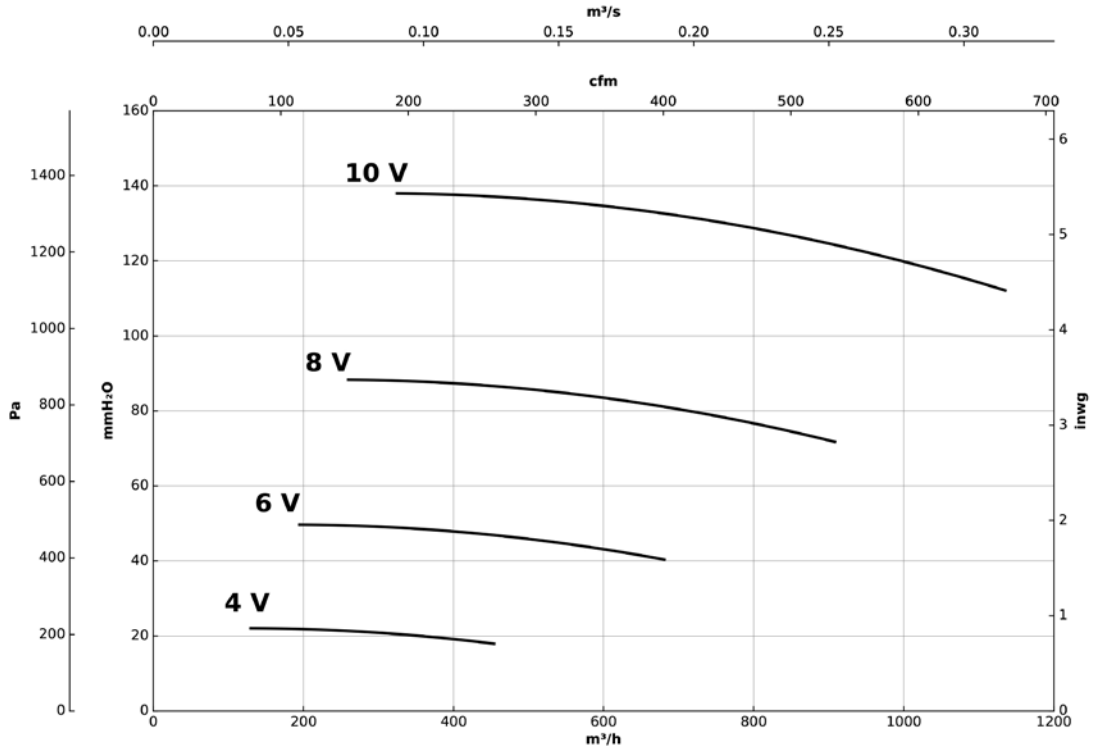

### CPV/EC-1020-2M-1

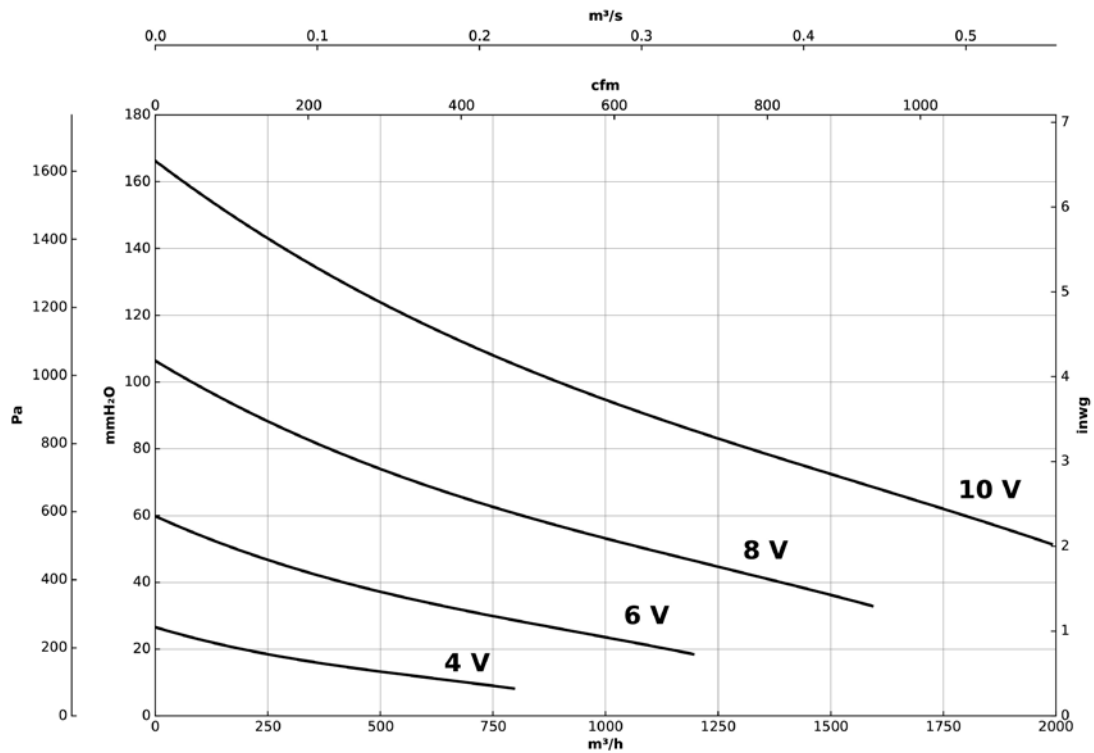

### Characteristic curves

Q= Flow rate in m<sup>3</sup>/h, m<sup>3</sup>/s and cfm

Pe= Static pressure in mm H<sub>2</sub>O, Pa and inwg

**CPV/EC-1020-4M-0.33**

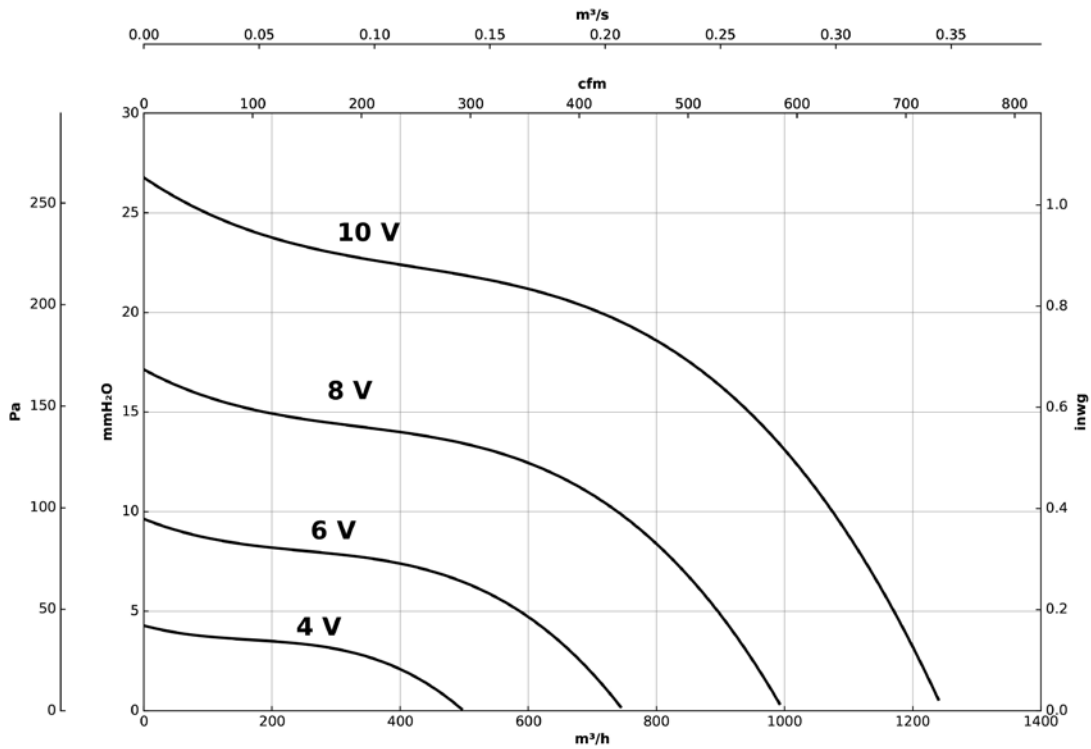

**CPV/EC-1325-4M-0.5**

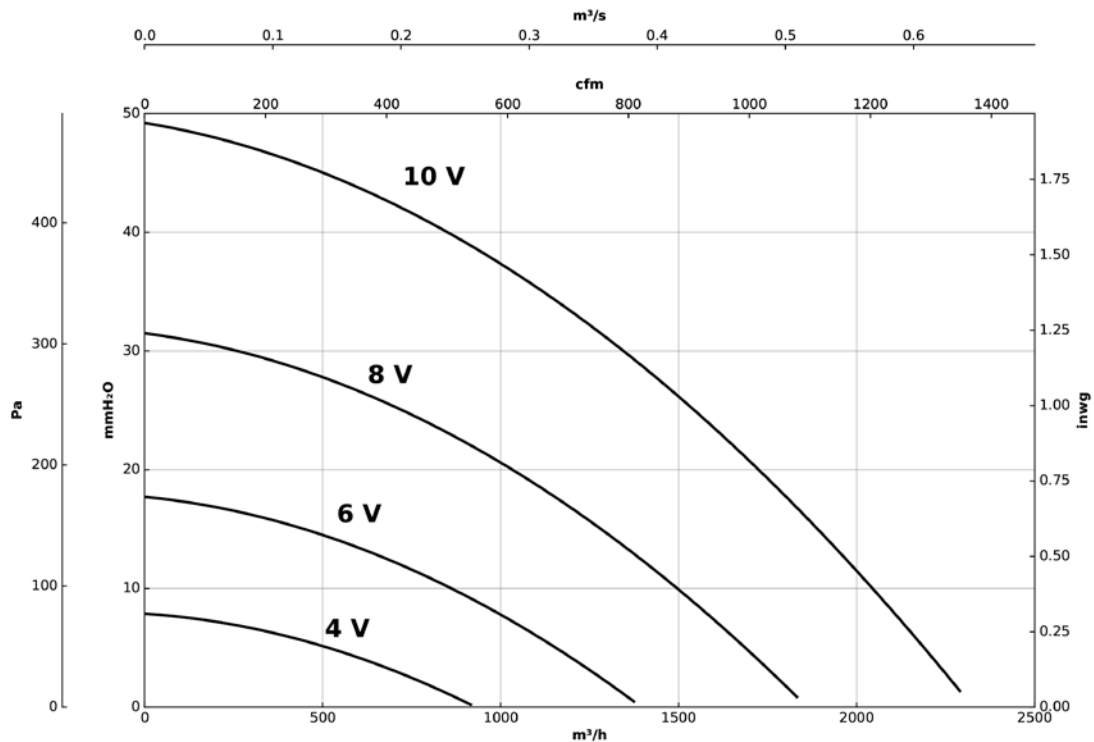

## Characteristic curves

Q= Flow rate in m<sup>3</sup>/h, m<sup>3</sup>/s and cfm

Pe= Static pressure in mm H<sub>2</sub>O, Pa and inwg

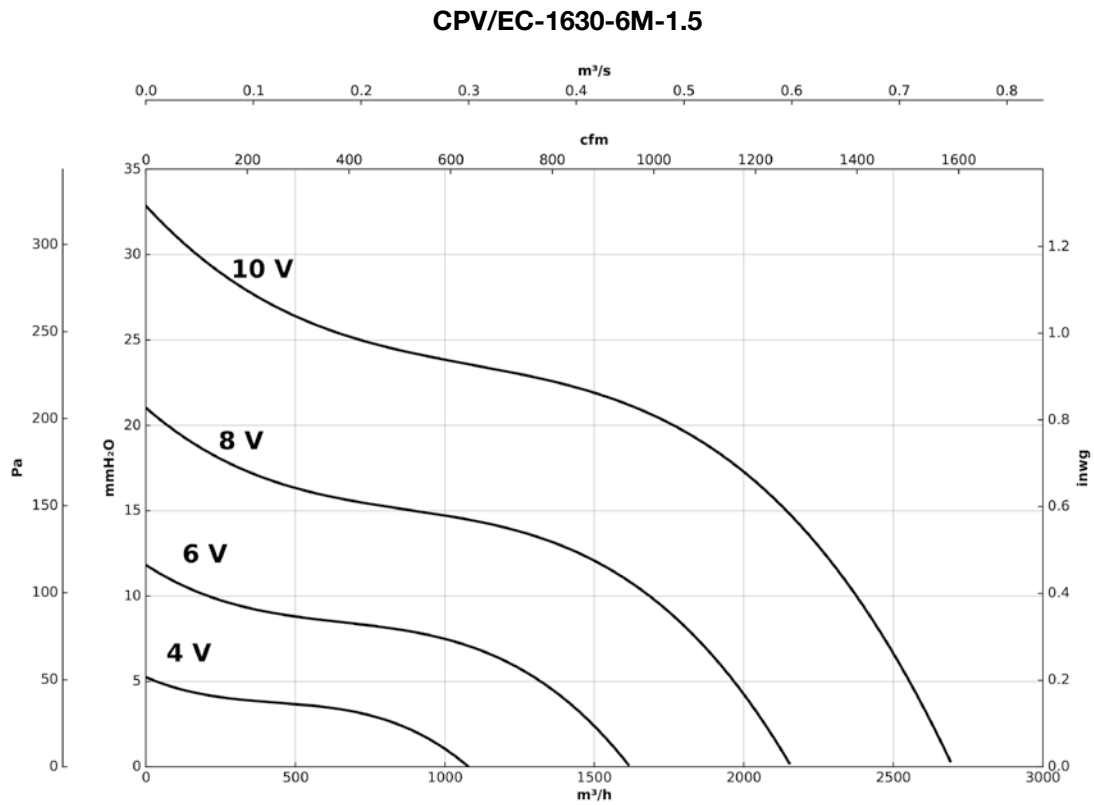

## Accessories





# CKDR/EC

Extract units with large door and 40 mm acoustic insulation, equipped with EC Technology IE5 motor



Extraction units with large door for easy maintenance and 40 mm acoustic insulation, equipped with EC Technology IE5 motor with integrated electronics.

#### Fan:

- Galvanised sheet steel structure.
- 40 mm acoustic insulation.
- Backward curved impeller made of sheet steel.
- Changeable opening door direction thanks to its interchangeable hinges.
- Adjustable in different positions.
- Prepared for continuous work at 120 °C.
- Motor cover accessory (CM) supplied with fan.

- Single-phase 230 V 50/60 Hz.
- Working temperature: -25 °C +60 °C.

EC CONTROL: Supplied as an optional accessory. Control panel for ventilation systems with EC Technology motors with the electronics integrated in the motor itself. With the following characteristics:

- CPC: Constant pressure control.
- CFC: Constant flow control.
- DAY/NIGHT: Double pressure setpoint adjustment according to time of day.
- External sensor: compatible with temperature, humidity, air quality or CO sensor.
- Equipment preconfigured in constant pressure mode with 100 Pa set point.



EC TECHNOLOGY MOTOR with integrated electronics



EC CONTROL Supplied as an optional accessory

#### Motor:

- High efficiency EC Technology motors with integrated electronics, regulated by 0-10 V or 4-20 mA.
- IE5 efficiency motors, class F and IP55 protection.

#### Finish:

- Anti-corrosive in galvanized steel sheet.

## Order code

**CKDR/EC – 280 – 2M – 1 – IE5**

CKDR/EC: Extract units with large door and 40 mm acoustic insulation, equipped with EC Technology IE5 motor

Impeller size

Number of motor poles  
2=2900 r/min 50 Hz  
4=1400 r/min 50 Hz

M = Single-phase

Motor power (HP)

IE5 motor

## Technical characteristics

Model	Speed	Maximum admissible current (A)	Max. electric power (kW)	Maximum flow rate (m³/h)	Sound pressure level (dB (A))	Approx. weight (Kg)	According ErP*
	(r/min)						
CKDR/EC-280-2M-1 IE5	2825	5.9	0.75	2090	71	38	2020
CKDR/EC-315-2M-1,5 IE5	2830	8.7	1.10	3900	72	55	2020
CKDR/EC-355-4M-0.5 IE5	1400	3.4	0.37	2670	60	71	2020
CKDR/EC-400-4M-0.75 IE5	1400	4.8	0.55	3770	56	71	2020
CKDR/EC-450-4M-1 IE5	1410	5.8	0.75	5020	60	77	2020
CKDR/EC-500-4M-1.5 IE5	1455	8.9	1.10	7440	62	106	2020

\* In accordance with the ErP 2020 draft



## Erp. (Energy Related Products)

Information on Directive 2009/125/EC can be downloaded from the SODECA website or the QuickFan selector programme.

### Acoustic characteristics

The indicated values are determined by measuring the sound pressure level and sound power in dB(A) obtained in a free field at a distance equivalent to twice the size of the fan plus the impeller diameter, with a minimum of 1.5 m.

Sound power spectrum Lw(A) in dB(A) per Hz frequency band

	63	125	250	500	1000	2000	4000	8000		63	125	250	500	1000	2000	4000	8000
CKDR/EC-280-2M-1	53	67	73	74	76	77	73	71	CKDR/EC-400-4M-0.75	41	60	62	63	65	64	58	53
CKDR/EC-315-2M-1,5	50	67	77	77	79	79	74	71	CKDR/EC-450-4M-1	45	66	67	67	68	69	64	58
CKDR/EC-355-4M-0.5	43	62	64	65	68	67	61	55	CKDR/EC-500-4M-1.5	49	68	64	69	74	68	63	60

### Dimensions mm

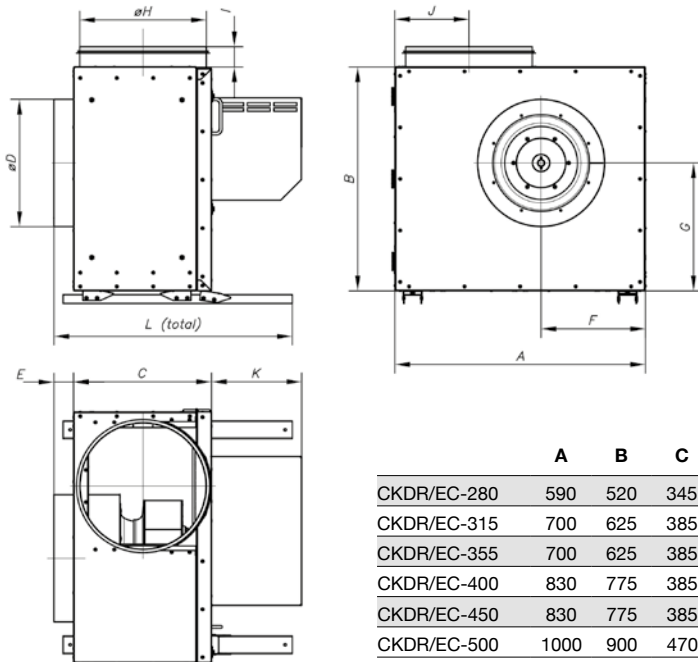

	A	B	C	ØD	E	F	G	ØH	I	J	K	L
CKDR/EC-280	590	520	345	315	52	245	290	315	48	192,5	210	612
CKDR/EC-315	700	625	385	355	55	290	356	355	56	207	210	665
CKDR/EC-355	700	625	385	355	55	290	356	355	56	207	188	665
CKDR/EC-400	830	775	385	355	55	354	418	355	56	212	209	660
CKDR/EC-450	830	775	385	355	55	354	418	355	56	212	229	660
CKDR/EC-500	1000	900	470	400	75	420	505	400	75	244	229	865

### Accessories



### Characteristic curves

Q= Flow rate in m<sup>3</sup>/h, m<sup>3</sup>/s and cfm

Pe= Static pressure in mm H<sub>2</sub>O, Pa and inwg

#### CKDR-280-2M-1 IE5

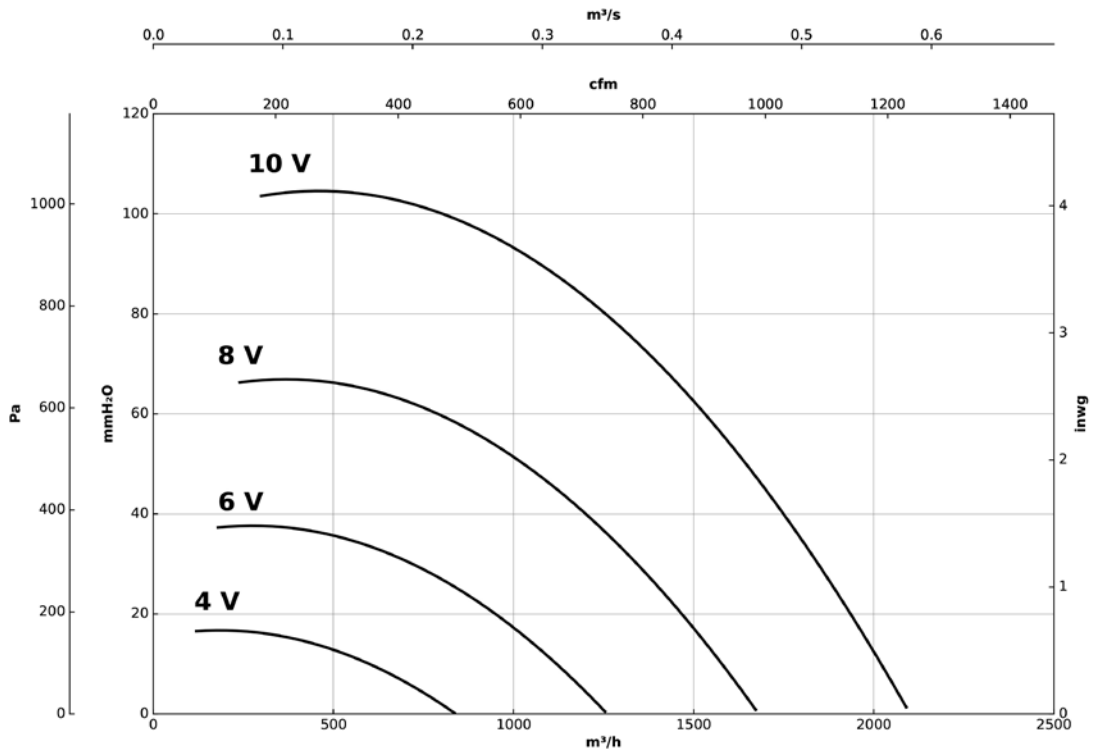

#### CKDR-315-2M-1,5 IE5

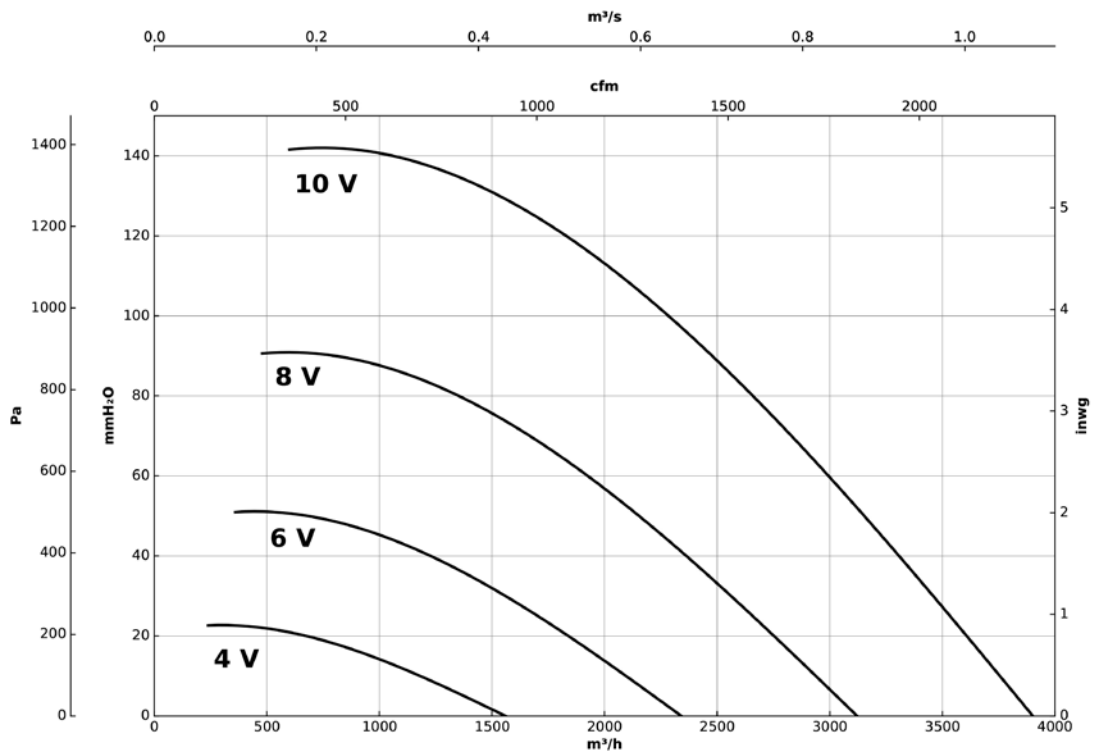

### Characteristic curves

Q= Flow rate in m<sup>3</sup>/h, m<sup>3</sup>/s and cfm

Pe= Static pressure in mm H<sub>2</sub>O, Pa and inwg

#### CKDR-355-4M-0.5 IE5

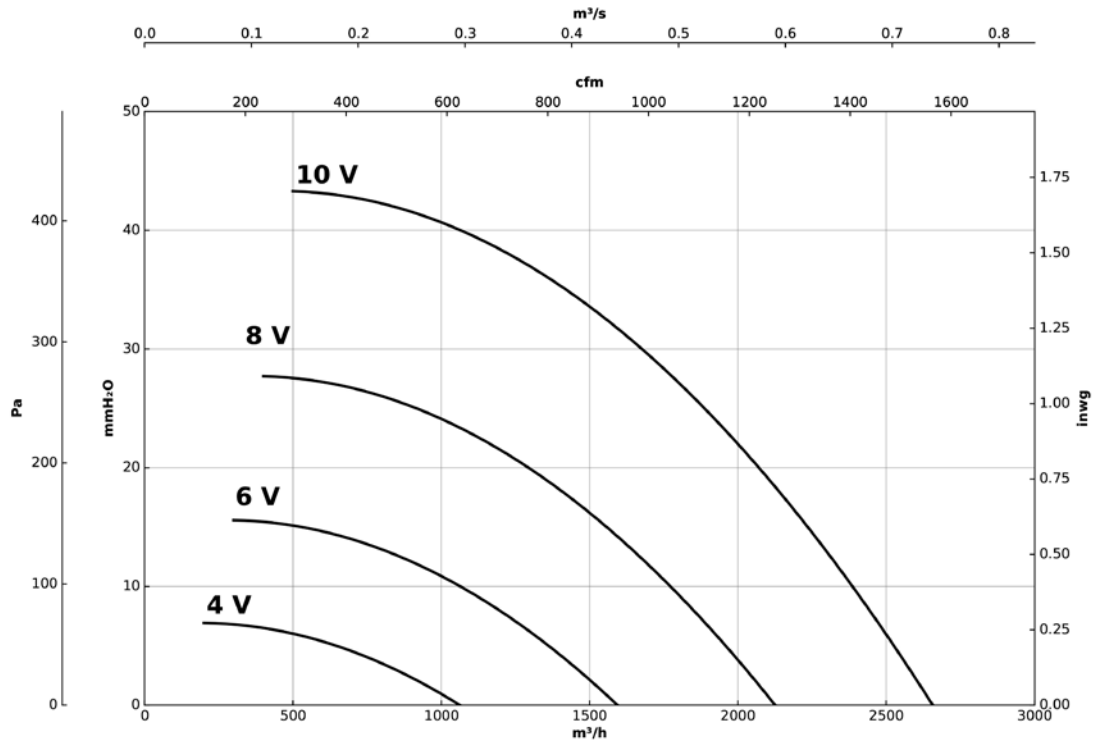

#### CKDR-400-4M-0.75 IE5

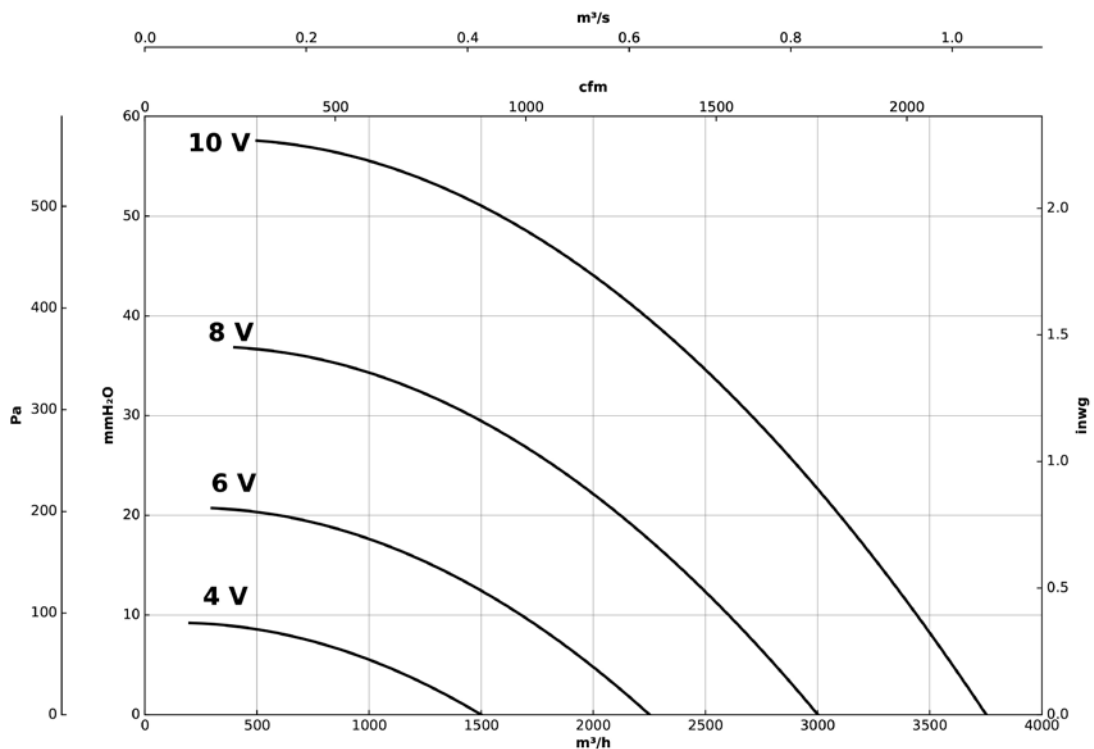

### Characteristic curves

Q= Flow rate in m<sup>3</sup>/h, m<sup>3</sup>/s and cfm

Pe= Static pressure in mm H<sub>2</sub>O, Pa and inwg

#### CKDR-450-4M-1 IE5

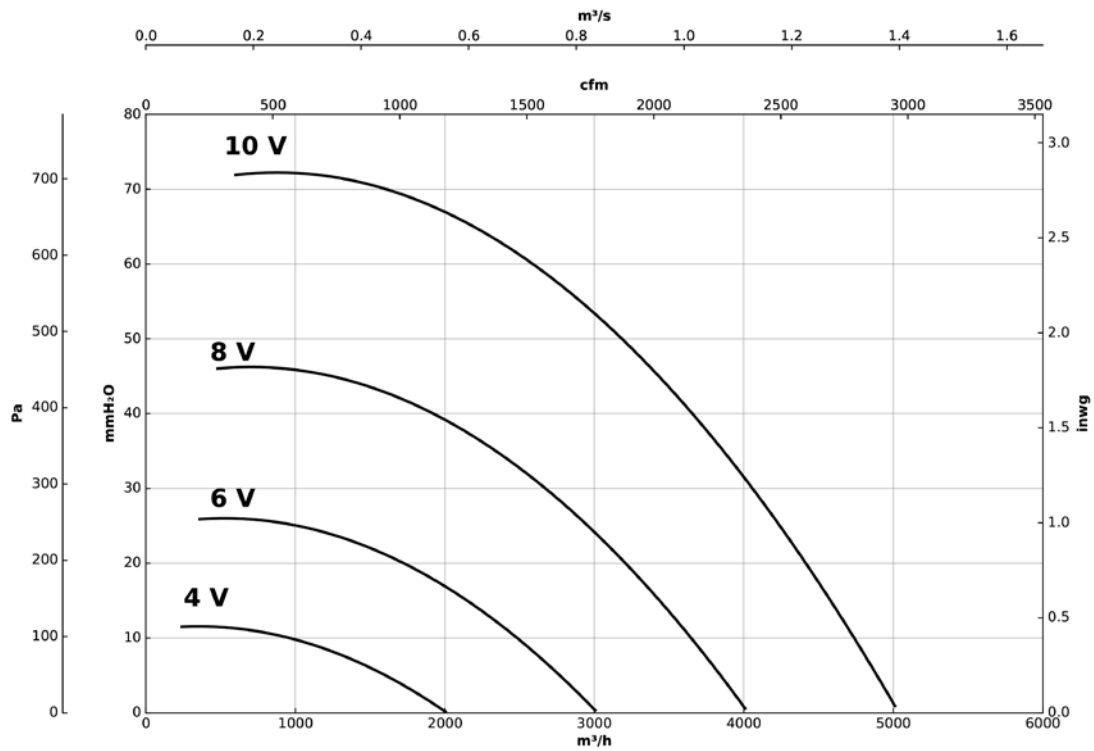

#### CKDR-500-4M-1.5 IE5

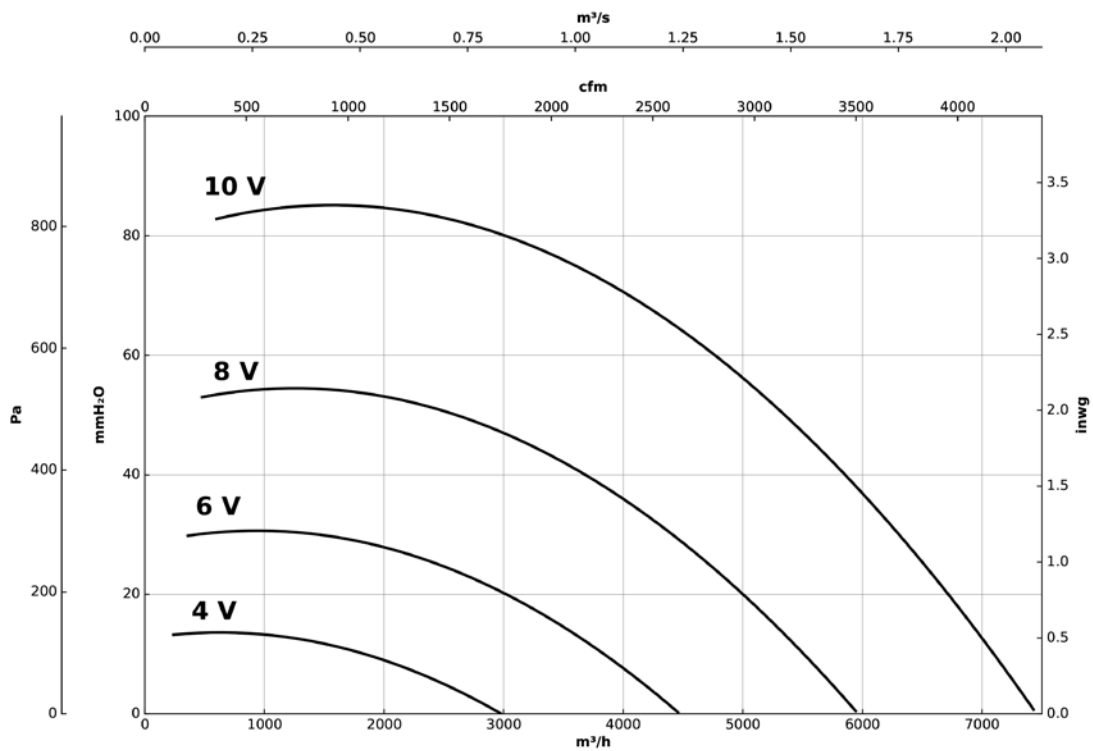

# CJLINE/EC

Air extract units with linear inlet and outlet, equipped with EC Technology IE5 motor



Air extraction units with linear inlet and outlet, equipped with EC Technology IE5 motor with integrated electronics.

**Fan:**

- Galvanised sheet steel structure.
- Backward curved impeller made of sheet steel.
- Linear airflow direction.

**Motor:**

- High efficiency EC Technology motors with integrated electronics, regulated by 0-10 V or 4-20 mA.
- IE5 efficiency motors, class F and IP55 protection.
- Single-phase 230 V 50/60 Hz.
- Working temperature: -25 °C +60 °C.

**EC CONTROL:** Supplied as an optional accessory. Control panel for ventilation systems with EC Technology motors with the electronics integrated in the motor itself. With the following characteristics:

- CPC: Constant pressure control.
- CFC: Constant flow control.
- DAY / NIGHT: Double pressure setpoint adjustment according to time of day.
- External sensor: compatible with temperature, humidity, air quality or CO sensor.
- Equipment preconfigured in constant pressure mode with 100 Pa set point.

**Finish:**

- Anti-corrosive in galvanized steel sheet.



EC TECHNOLOGY MOTOR with integrated electronics



EC CONTROL Supplied as an optional accessory

## Order code

**CJLINE/EC – 1131 – 4M – 0.33 – IE5**

CJLINE/EC: Air extract units with linear inlet and outlet, equipped with EC Technology IE5 motor

Impeller size

Number of motor poles  
4=1400 r/min 50 Hz  
6=900 r/min 50 Hz

M = Single-phase

Motor power (HP)

IE5 motor

## Technical characteristics

Model	Speed (r/min)	Maximum admissible current (A)	Max. electric power	Maximum flow rate (m <sup>3</sup> /h)	Sound pressure level dB (A)	Approx. weight (Kg)	According ErP
		230V	(kW)				
CJLINE/EC-1131-4M-0.33 IE5	1370	2.3	0.25	1980	51	42	2018
CJLINE/EC-1235-4M-0.33 IE5	1370	2.3	0.25	2820	56	54	2018
CJLINE/EC-1640-4M-0.75 IE5	1385	4.8	0.55	4430	61	76	2018
CJLINE/EC-1845-4M-1.5 IE5	1455	8.9	1.10	6300	65	87	2018
CJLINE/EC-1856-6M-1 IE5	945	4.3	0.75	8100	59	135	2018
CJLINE/EC-2063-6M-1 IE5	945	4.3	0.75	9900	61	188	2018



## Erp. (Energy Related Products)

Information on Directive 2009/125/EC can be downloaded from the SODECA website or the QuickFan selector programme.

### Acoustic characteristics

The indicated values are determined by measuring the sound pressure level and sound power in dB(A) obtained in a free field at a distance equivalent to twice the size of the fan plus the impeller diameter, with a minimum of 1.5 m.

Sound power spectrum Lw(A) in dB(A) per Hz frequency band

	63	125	250	500	1000	2000	4000	8000
CJLINE/EC-1131-4M	42	51	57	56	60	60	52	46
CJLINE/EC-1235-4M	49	58	64	63	67	66	59	53
CJLINE/EC-1640-4M	56	62	67	68	71	73	65	59
CJLINE/EC-1845-4M	60	66	71	72	75	77	69	63
CJLINE/EC-1856-6M	58	64	69	70	73	72	65	60
CJLINE/EC-2063-6M	60	66	72	72	76	76	68	61

### Dimensions mm

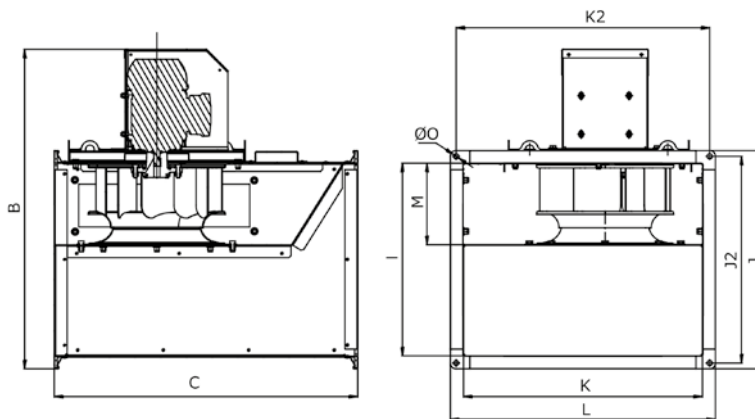

	B	C	I	J	J2	K	K2	L	M2	ØO
CJLINE/EC-1131-4M	783	710	451	510	483	561	593	620	194	12
CJLINE/EC-1235-4M	833	800	501	560	533	621	653	680	222	12
CJLINE/EC-1640-4M	896	900	561	620	593	711	743	770	244	12
CJLINE/EC-1845-4M	965	1000	631	690	663	801	833	860	277	12
CJLINE/EC-1856-6M	1133	1250	801	860	833	1001	1033	1060	348	12
CJLINE/EC-2063-6M	1242	1400	900	980	940	1124	1165	1205	410	14

### Accessories



## Characteristic curves

Q= Flow rate in m<sup>3</sup>/h, m<sup>3</sup>/s and cfm

Pe= Static pressure in mm H<sub>2</sub>O, Pa and inwg

### CJLINE/EC-1131-4M

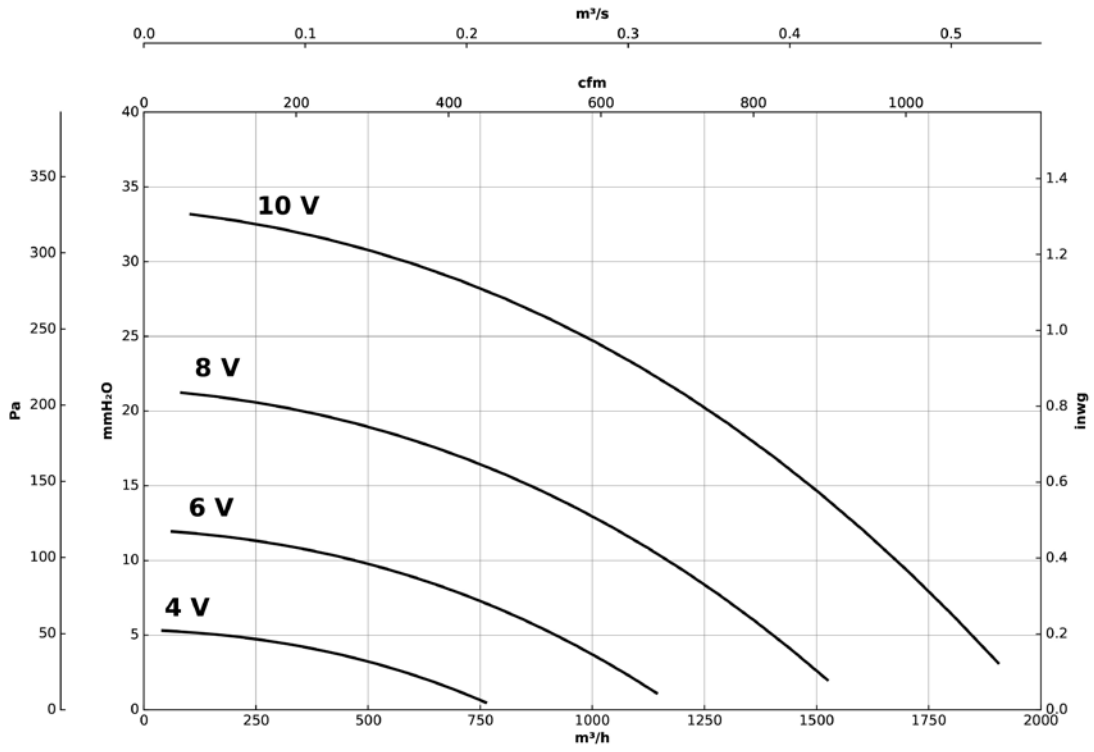

### CJLINE/EC-1235-4M

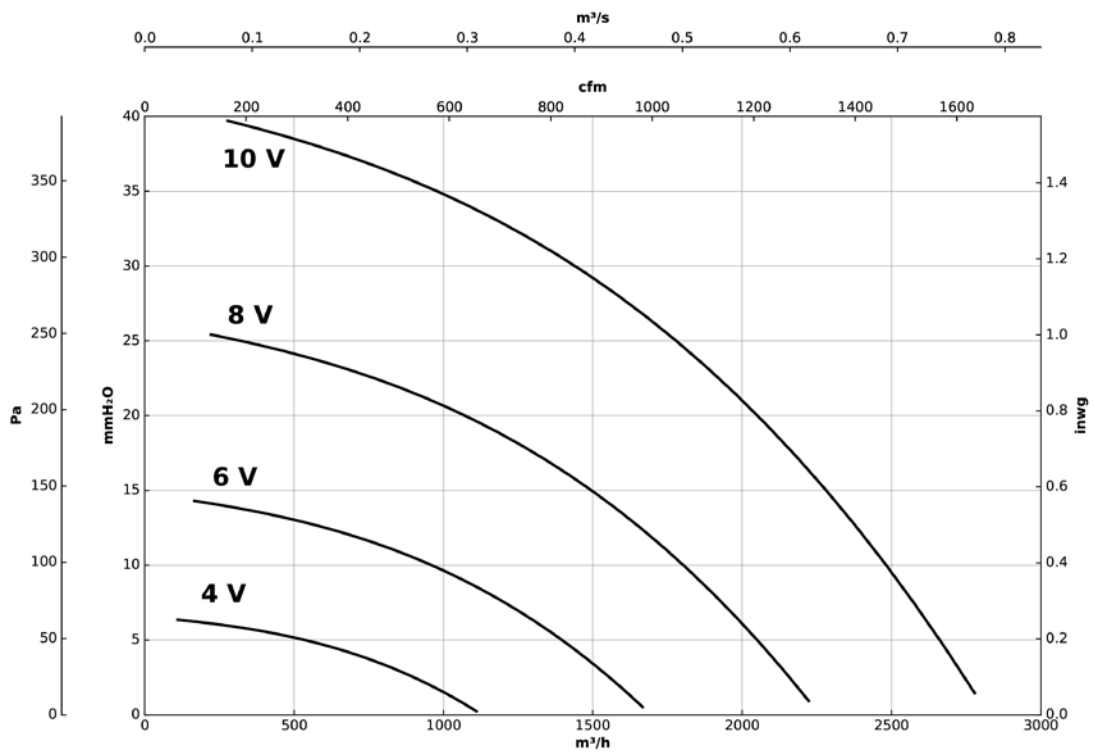



### Characteristic curves

Q= Flow rate in m<sup>3</sup>/h, m<sup>3</sup>/s and cfm

Pe= Static pressure in mm H<sub>2</sub>O, Pa and inwg

#### CJLINE/EC-1640-4M

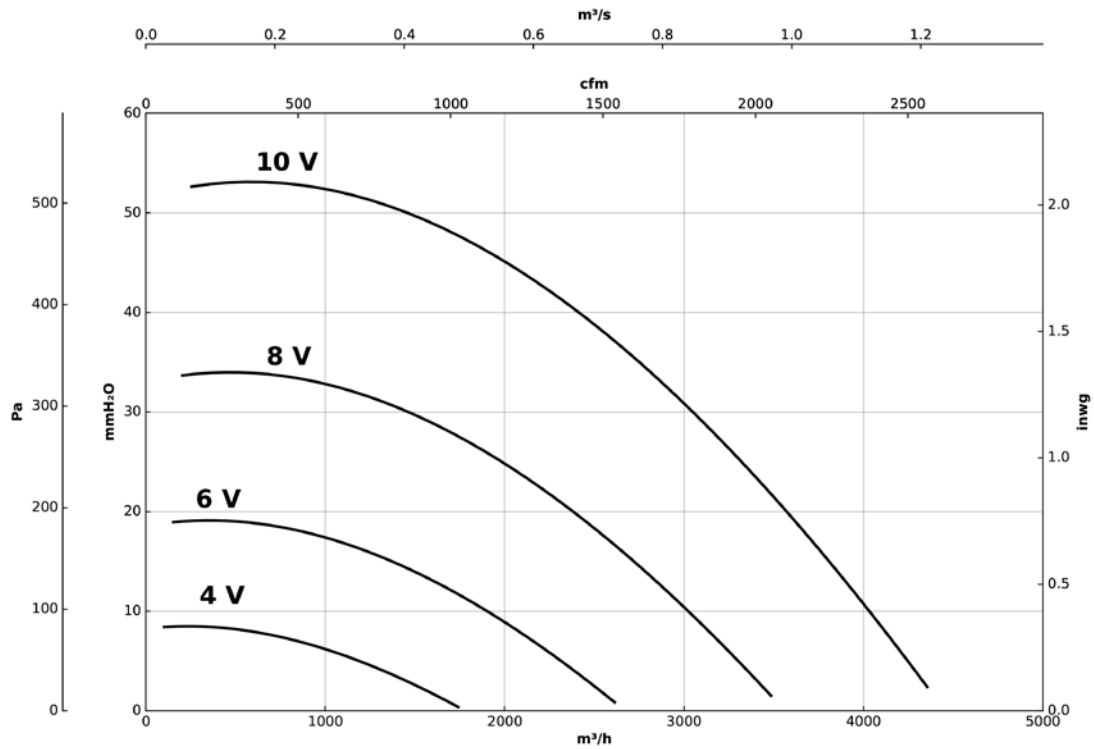

#### CJLINE/EC-1845-4M

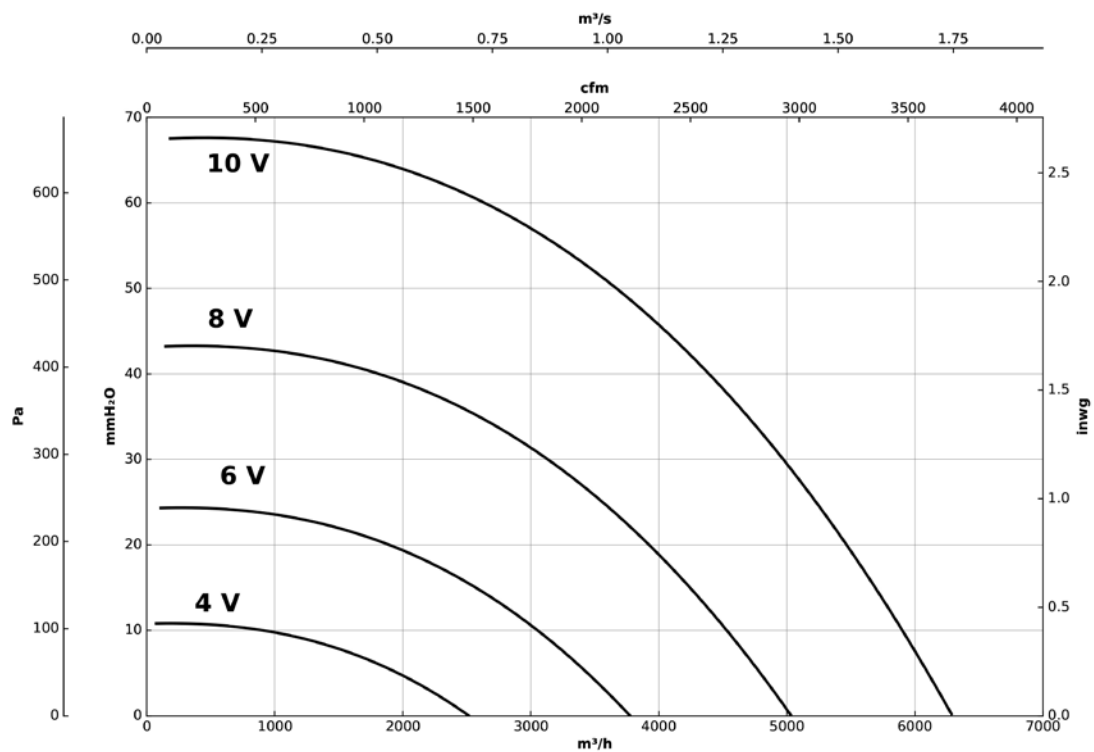

## Characteristic curves

Q= Flow rate in m<sup>3</sup>/h, m<sup>3</sup>/s and cfm

Pe= Static pressure in mm H<sub>2</sub>O, Pa and inwg

### CJLINE/EC-1856-6M

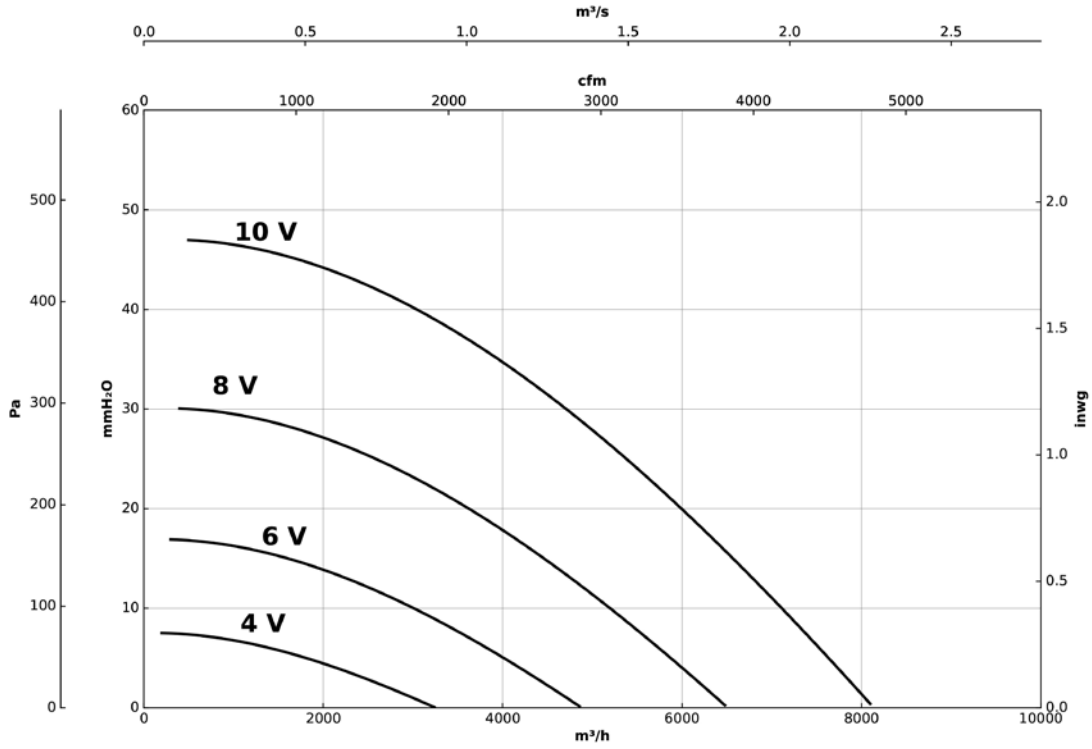

### CJLINE/EC-2063-4M

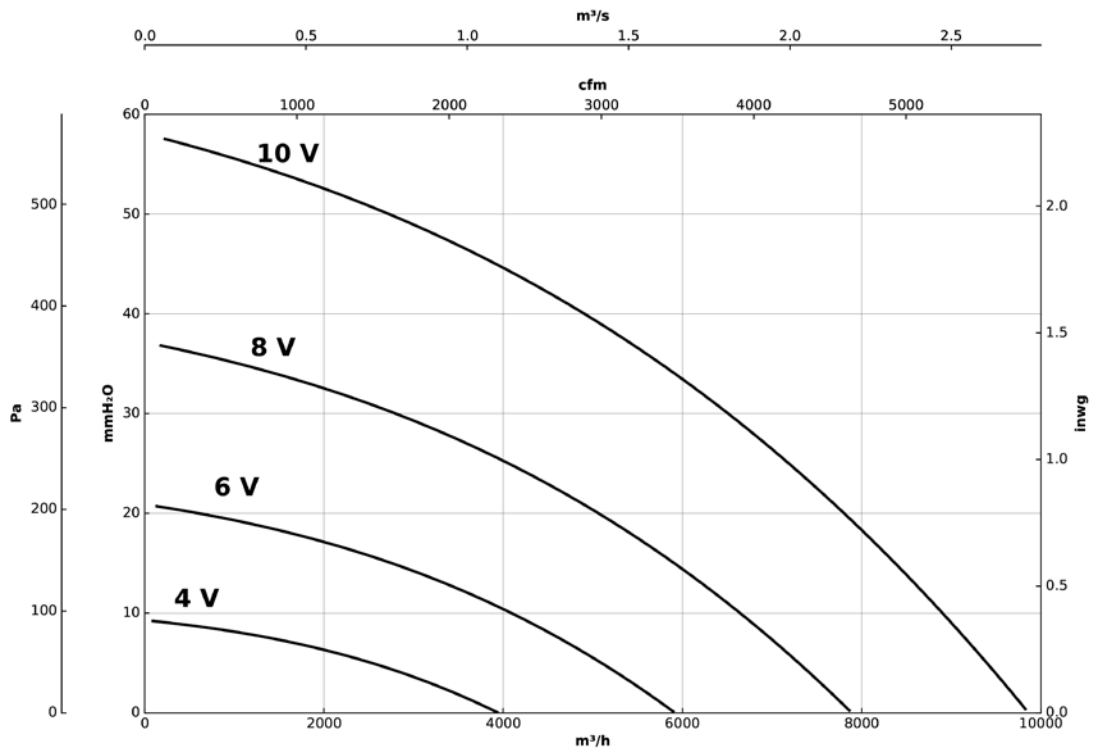

# HT/EC

**Axial rooftop fans with flat base, with EC Technology IE5 motor**



HT/EC-45...63



HT/EC-71...100



EC TECHNOLOGY MOTOR with integrated electronics



EC CONTROL Supplied as an optional accessory

Axial roof fans, with fiberglass reinforced plastic impeller, with flat base, equipped with EC Technology IE5 motor with integrated electronics, specially designed to obtain high energy efficiency.

**Fan:**

- Support base in painted galvanized steel sheet.
- Fibreglass reinforced polyamide-6 impeller.
- Bird protection grid.
- Anti-rain deflector cap in painted galvanized sheet steel, with anti-corrosion protection.
- Airflow direction from motor to impeller.

**Motor:**

- High efficiency EC Technology motors with integrated electronics, regulated by 0-10 V or 4-20 mA.
- IE5 efficiency motors, class F and IP55 protection.
- Single-phase 230 V 50/60 Hz and three-phase 400 V 50/60 Hz.
- Working temperature: -25 °C +60 °C.

**EC CONTROL:** Supplied as an optional accessory. Control panel for ventilation systems with EC Technology motors with the electronics integrated in the motor itself. With the following characteristics:

- CPC: Constant pressure control.
- CFC: Constant flow control.
- DAY/NIGHT: Double pressure setpoint adjustment according to time of day.
- External sensor: compatible with temperature, humidity, air quality or CO sensor.
- Equipment preconfigured in constant pressure mode with 100 Pa set point.

**Finish:**

- Anti-corrosive finish in polyester resin, polymerised at 190 °C, after degreasing with phosphate-free nanotechnology treatment.

## Order code

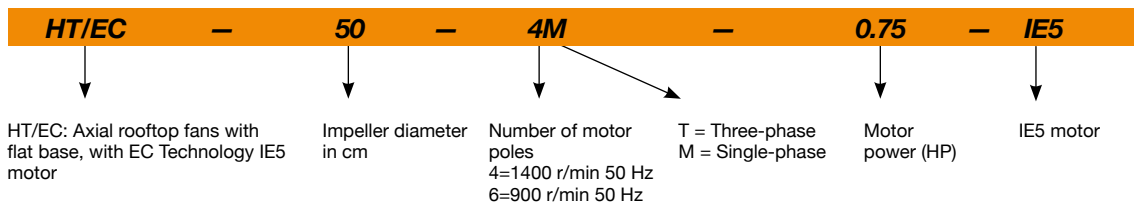

## Technical characteristics

Model	Speed (r/min)	Maximum admissible current (A)		Max. electric power (kW)	Maximum flow rate (m³/h)	Sound pressure level dB (A)		Approx. weight (Kg)	According ErP
		230V	400V			Inlet	Exhaust		
HT/EC-45-4M-0.5 IE5	1400	3.4		0.37	6500	55	54	50	2018
HT/EC-50-4M-0.75 IE5	1350	4.8		0.55	8500	59	57	62	2018
HT/EC-56-4M-1 IE5	1420	5.8		0.75	9800	61	57	63	2018
HT/EC-63-4M-1.5 IE5	1455	8.9		1.10	14000	63	59	94	2018
HT/EC-71-4M-1.5 IE5	1440	8.9		1.10	18000	69	67	109	2018
HT/EC-80-4T-3 IE5	1435		5.9	2.20	26200	73	70	163	2018
HT/EC-90-4T-5.5 IE5	1450		10.6	4.00	31500	78	75	210	2018
HT/EC-100-6T-2 IE5	950		2.9	1.50	25000	71	68	220	2018
HT/EC-100-6T-3 IE5	950		7.5	2.20	28200	75	72	231	2018



## Erp. (Energy Related Products)

Information on Directive 2009/125/EC can be downloaded from the SODECA website or the QuickFan selector programme.

### Acoustic characteristics

The indicated values are determined by measuring the pressure and sound power levels in dB(A) obtained in a free field at a distance equivalent to twice the size of the fan plus the impeller diameter, with a minimum of 1.5 m.

#### Sound power spectrum Lw(A) in dB(A) per Hz frequency band

##### Values measured at inlet with maximum flow rate (Qmax)

HT/EC-45-4M	32	49	61	69	74	74	70	63
HT/EC-50-4M	36	53	65	73	78	78	74	67
HT/EC-56-4M	38	55	67	75	80	80	76	69
HT/EC-63-4M	40	57	69	77	82	82	78	71
HT/EC-71-4M	46	63	75	83	88	88	84	77
HT/EC-80-4T	57	78	85	90	93	89	82	71
HT/EC-90-4T	61	82	89	94	97	93	86	75
HT/EC-100-6T-2	55	76	83	88	91	87	80	69
HT/EC-100-6T-3	59	80	87	92	95	91	84	73

##### Values measured at exhaust with maximum flow rate (Qmax)

HT/EC-45-4M	30	47	59	67	72	72	68	61
HT/EC-50-4M	34	51	63	71	76	76	72	65
HT/EC-56-4M	34	51	63	71	76	76	72	65
HT/EC-63-4M	36	53	65	73	78	78	74	67
HT/EC-71-4M	44	61	73	81	86	86	82	75
HT/EC-80-4T	54	75	82	87	90	86	79	68
HT/EC-90-4T	58	79	86	91	94	90	83	72
HT/EC-100-6T-2	52	73	80	85	88	84	77	66
HT/EC-100-6T-3	56	77	84	89	92	88	81	70

### Dimensions mm

#### HT/EC-45 ... 63

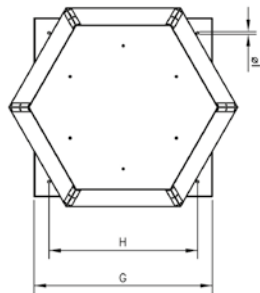
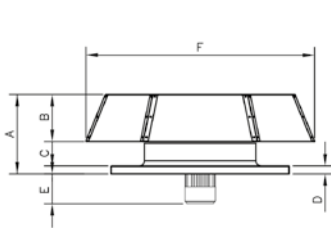

#### HT/EC-71 ... 100

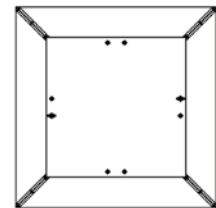
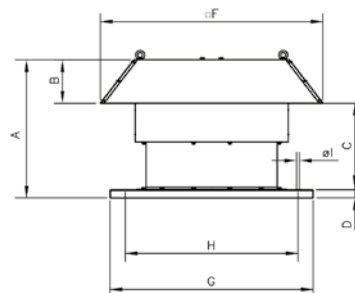

	A	B	C	D	E	F	G	H	ØI
HT/EC-45	342	202	90	50	171	923	710	590	12
HT/EC-50	373	238	85	50	193	1154	800	680	12
HT/EC-56	402	238	124	40	225	1154	800	750	14
HT/EC-63	457	277	141	40	171	1384	1000	850	14
HT/EC-71	760	195	525	40	-	1120	1000	850	14
HT/EC-80	790	215	525	50	-	1252	1150	1000	14
HT/EC-90	910	232	638	40	-	1380	1150	1000	14
HT/EC-100	1055	252	753	50	-	1527	1250	1100	14

### Accessories



INT



EC CONTROL



MTP



BTUB



MS



PA



BS



OP



S



SI-CO2 IND



SI-TEMP IND



SI-TEMP+HUMEDAD



SI-HUMEDAD



SI-MF



SI-PRESIÓN

### Characteristic curves

Q= Flow rate in m<sup>3</sup>/h, m<sup>3</sup>/s and cfm

Pe= Static pressure in mm H<sub>2</sub>O, Pa and inwg

#### HT/EC-45-4M

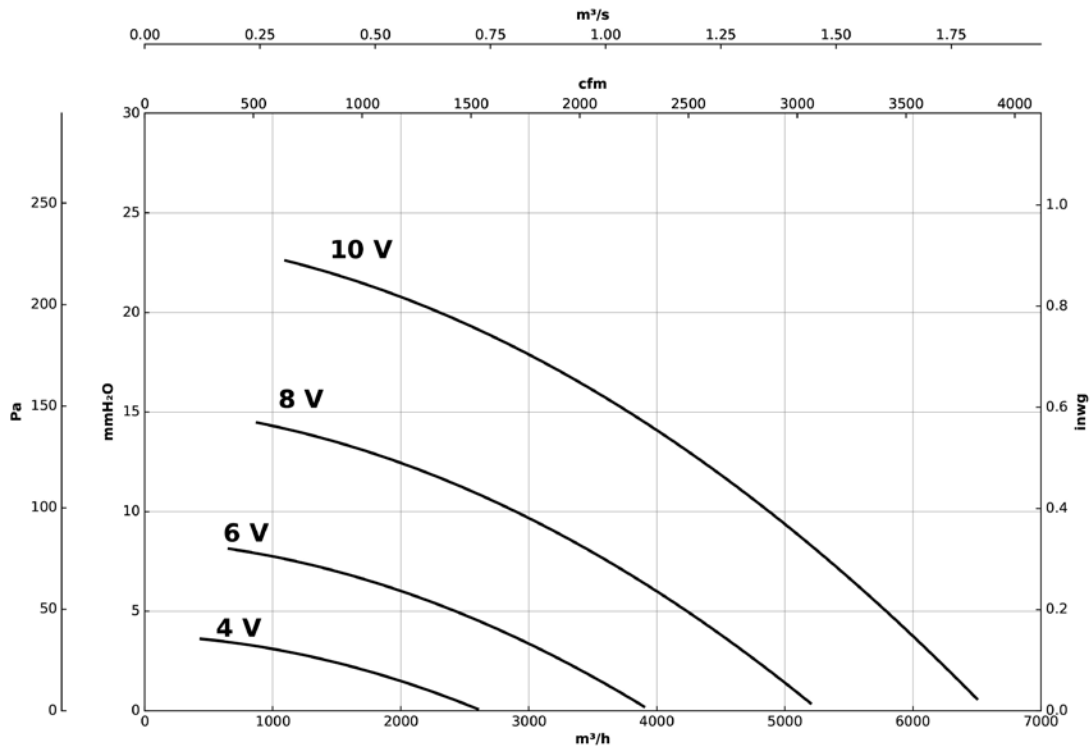

#### HT/EC-50-4M

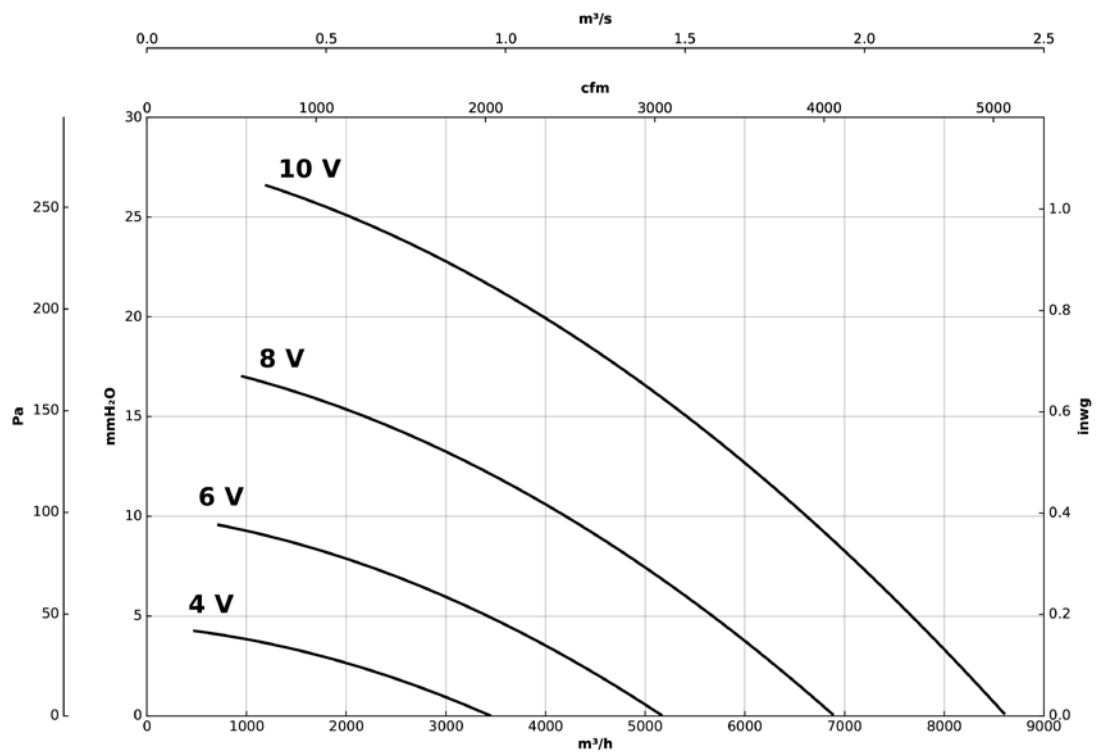

## Characteristic curves

Q= Flow rate in m<sup>3</sup>/h, m<sup>3</sup>/s and cfm

Pe= Static pressure in mm H<sub>2</sub>O, Pa and inwg

### HT/EC-56-4M

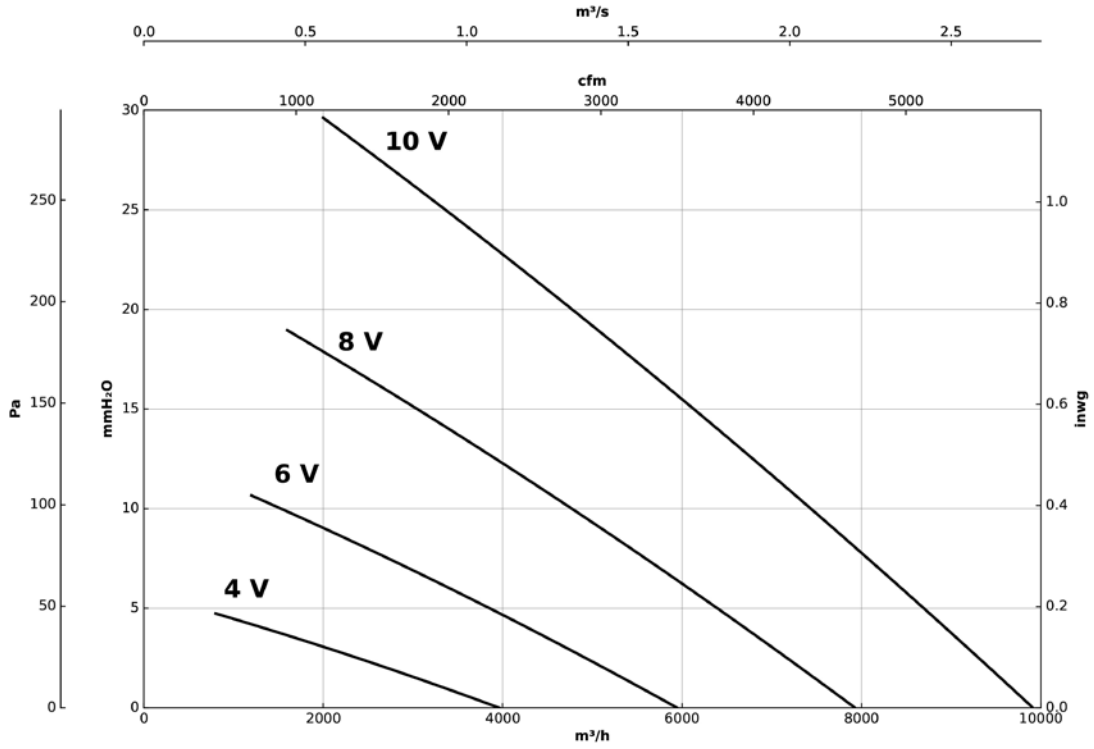

### HT/EC-63-4M

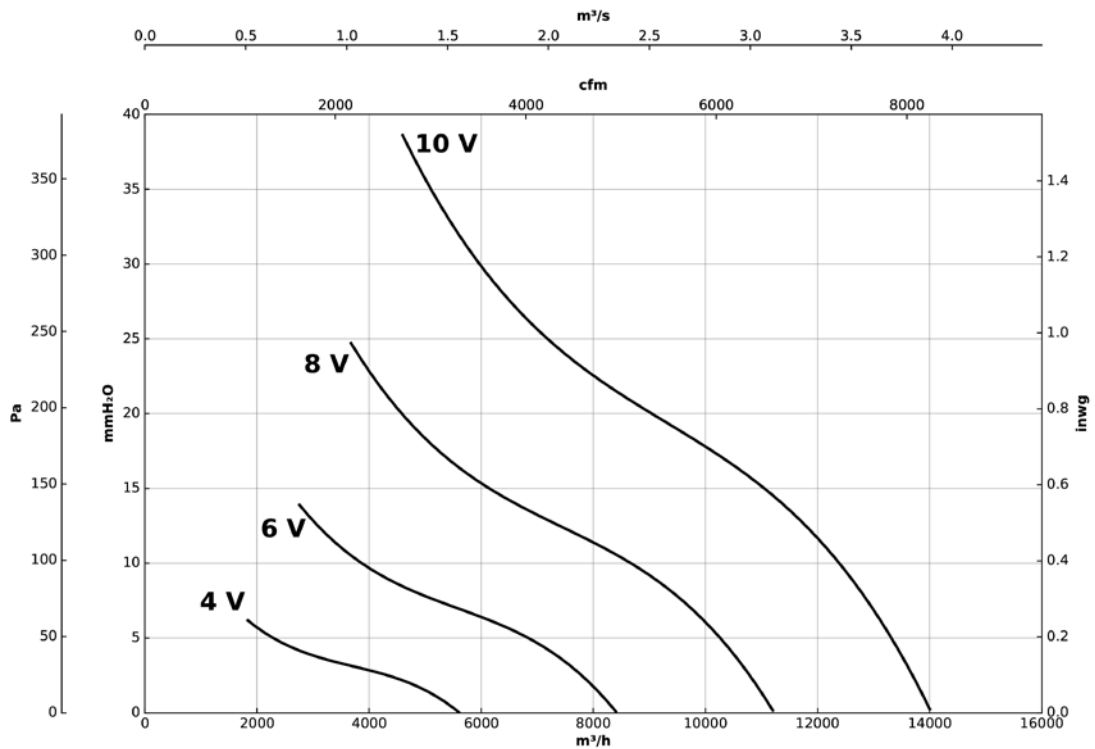

### Characteristic curves

Q= Flow rate in m<sup>3</sup>/h, m<sup>3</sup>/s and cfm

Pe= Static pressure in mm H<sub>2</sub>O, Pa and inwg

#### HT/EC-71-4M

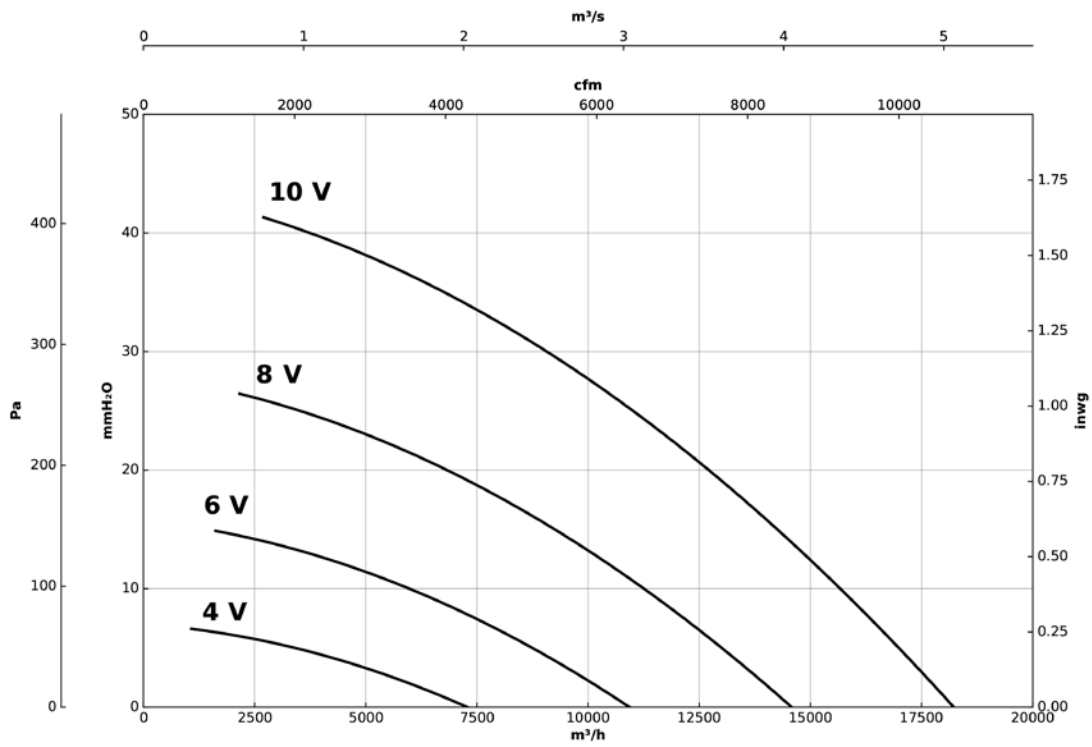

#### HT/EC-80-4T

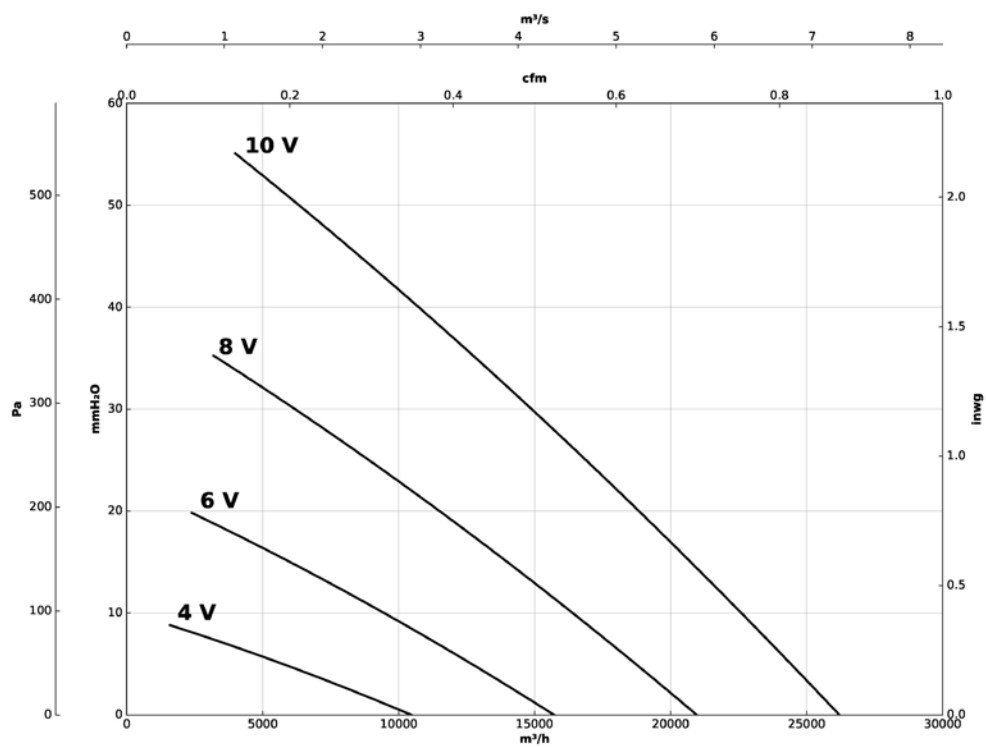

**Characteristic curves**

Q= Flow rate in m<sup>3</sup>/h, m<sup>3</sup>/s and cfm

Pe= Static pressure in mm H<sub>2</sub>O, Pa and inwg

**HT/EC-90-4T**

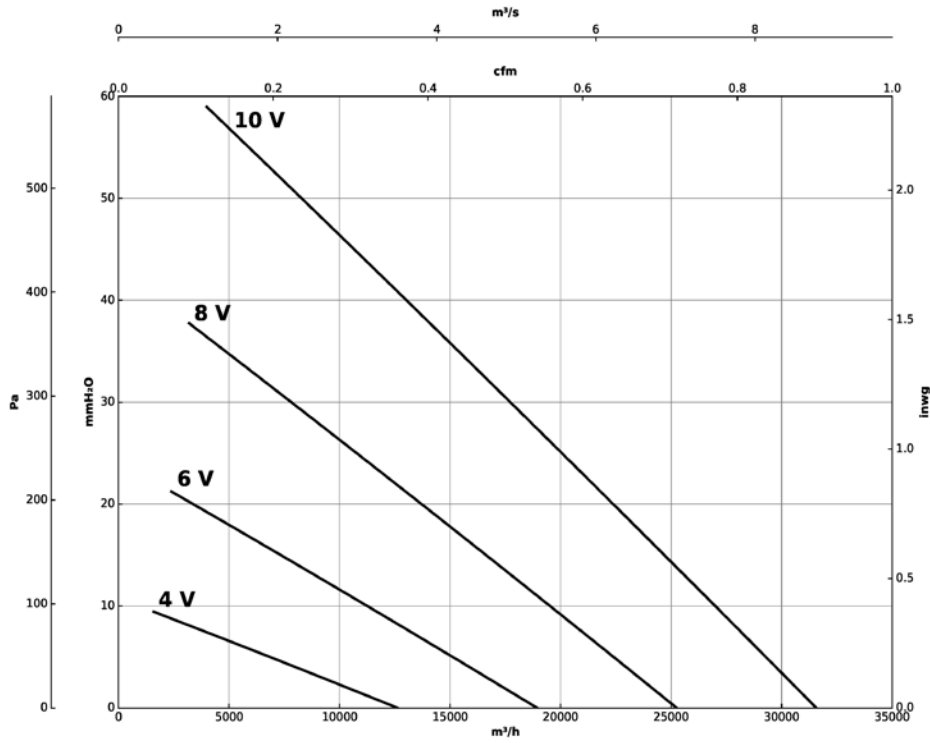

**HT/EC-100-6T-2**

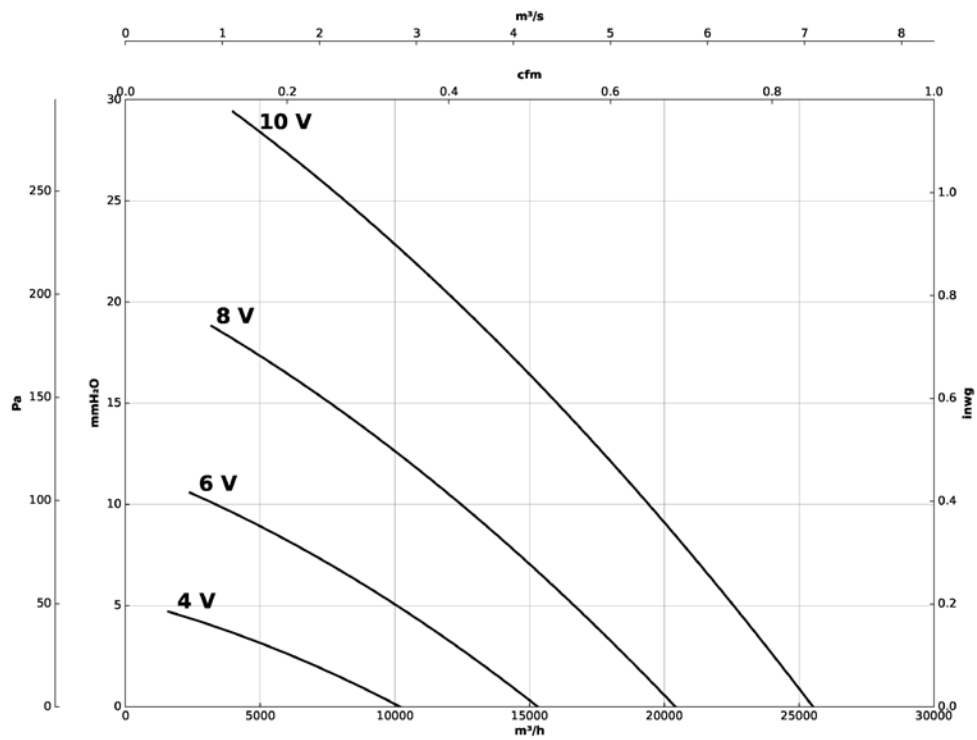



### Characteristic curves

Q= Flow rate in m<sup>3</sup>/h, m<sup>3</sup>/s and cfm

Pe= Static pressure in mm H<sub>2</sub>O, Pa and inwg

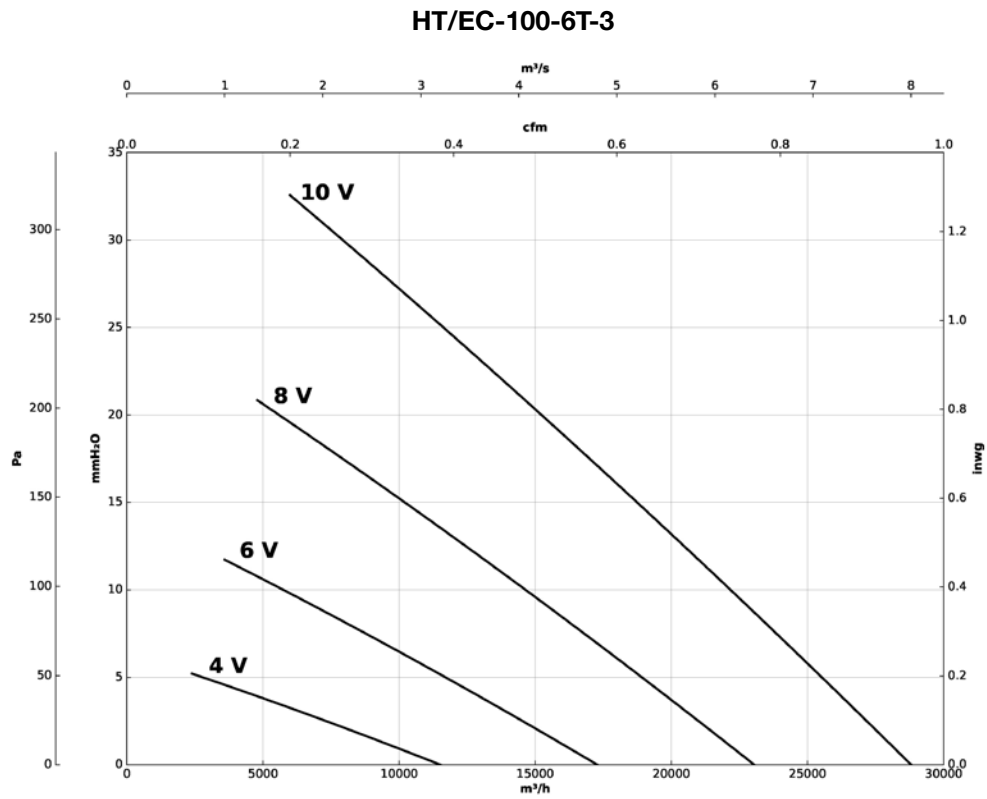

# CHT/EC

Centrifugal roof fans with horizontal air outlet, with EC Technology IE5 motor



#### Fan:

- Support base in galvanized steel sheet.
- Backward curved impeller made of galvanised sheet steel.
- Bird protection grid.
- Aluminum rain cover.
- Airflow direction from motor to impeller.

- DAY / NIGHT: Double pressure setpoint adjustment according to time of day.
- External sensor: compatible with temperature, humidity, air quality or CO sensor.
- Equipment preconfigured in constant pressure mode with 100 Pa set point.

#### Motor:

- High efficiency EC Technology motors with integrated electronics, regulated by 0-10 V or 4-20 mA.
- IE5 efficiency motors, class F and IP55 protection.
- Single-phase 230 V 50/60 Hz.
- Working temperature: -25 °C +60 °C.

#### Finish:

- Anti-corrosive in galvanized steel sheet and aluminum.



← EC TECHNOLOGY MOTOR with integrated electronics



← EC CONTROL Supplied as an optional accessory

EC CONTROL: Supplied as an optional accessory. Control panel for ventilation systems with EC Technology motors with the electronics integrated in the motor itself. With the following characteristics:

- CPC: Constant pressure control.
- CFC: Constant flow control.

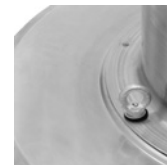

Support for roof-mounting



## Order code

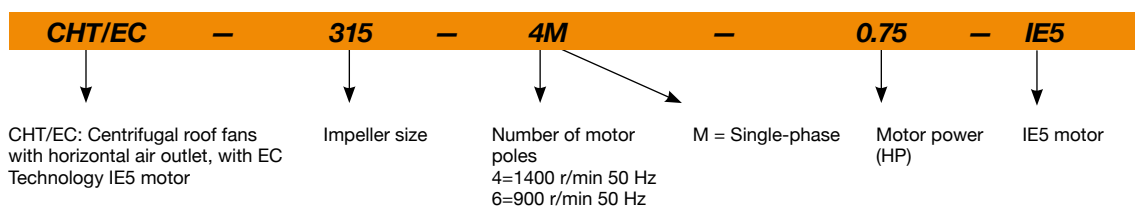

## Technical characteristics

Model	Speed (r/min)	Maximum admissible current (A)	Max. electric power (kW)	Maximum flow rate (m³/h)	Sound pressure level dB (A)		Approx. weight (Kg)	According ErP
		230V			Inlet	Exhaust		
CHT/EC-315-4M-0.75 IE5	1380	4.8	0.55	4950	48	54	39	2018
CHT/EC-400-6M-0.55 IE5	900	3.4	0.37	4500	44	50	56	2018
CHT/EC-450-6M-0.55 IE5	900	3.4	0.37	6900	47	54	59	2018



## Erp. (Energy Related Products)

Information on Directive 2009/125/EC can be downloaded from the SODECA website or the QuickFan selector programme.

### Acoustic characteristics

The indicated values are determined by measuring the sound pressure level and sound power in dB(A) obtained in a free field at a distance equivalent to twice the size of the fan plus the impeller diameter, with a minimum of 1.5 m.

#### Sound power spectrum Lw(A) in dB(A) per Hz frequency band

##### Values measured at inlet with maximum flow rate (Qmax)

	63	125	250	500	1000	2000	4000	8000
315-4M	50	56	62	62	65	68	59	53
400-6M	46	52	58	58	61	64	55	49
450-6M	50	57	62	62	66	65	58	53

##### Values measured at exhaust with maximum flow rate (Qmax)

	63	125	250	500	1000	2000	4000	8000
315-4M	49	61	69	71	72	72	84	58
400-6M	45	57	65	67	68	68	60	52
450-6M	50	62	70	72	73	70	63	55

### Dimensions mm

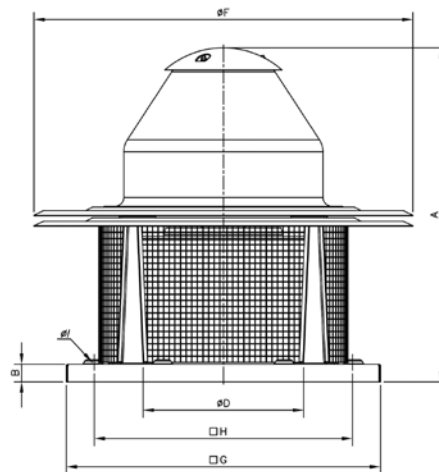

	A	B	øD*	øF	G	H	øI
CHT/EC-315-4M	670	30	355	726	560	450	12
CHT/EC-400-6M	755	40	500	856	710	590	12
CHT/EC-450-6M	770	40	500	856	710	590	12

\* Recommended nominal tube diameter

## Characteristic curves

Q= Flow rate in m<sup>3</sup>/h, m<sup>3</sup>/s and cfm

Pe= Static pressure in mm H<sub>2</sub>O, Pa and inwg

### CHT/EC-315-4M

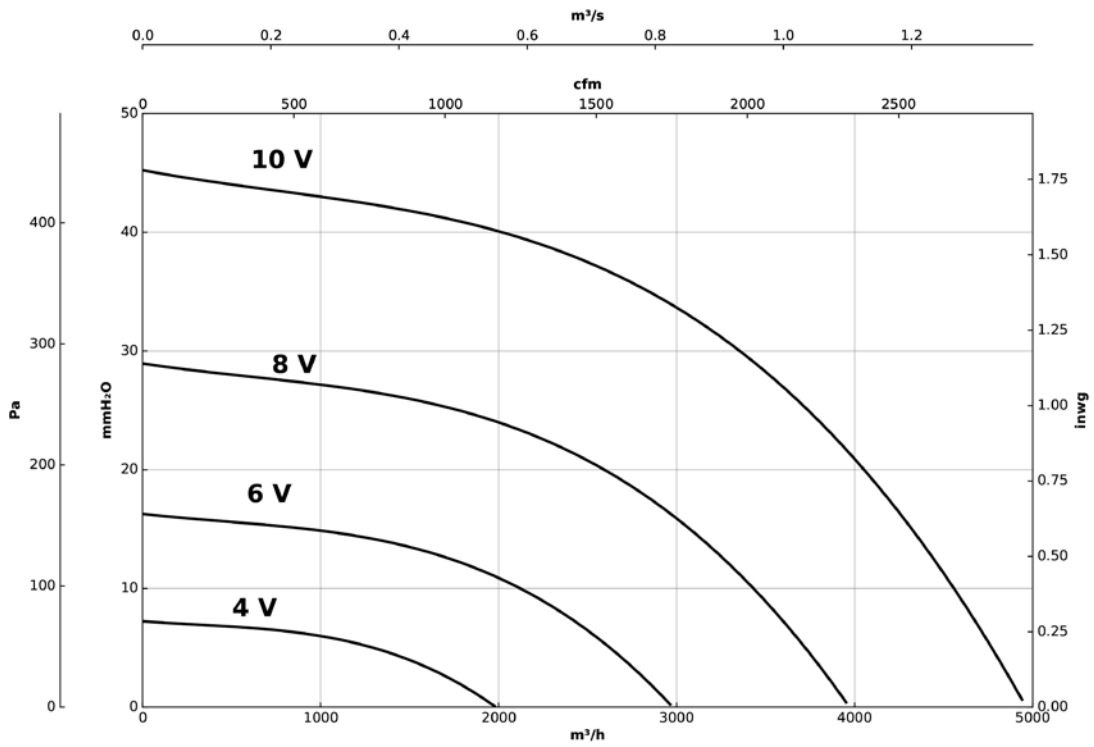

### CHT/EC-400-6M

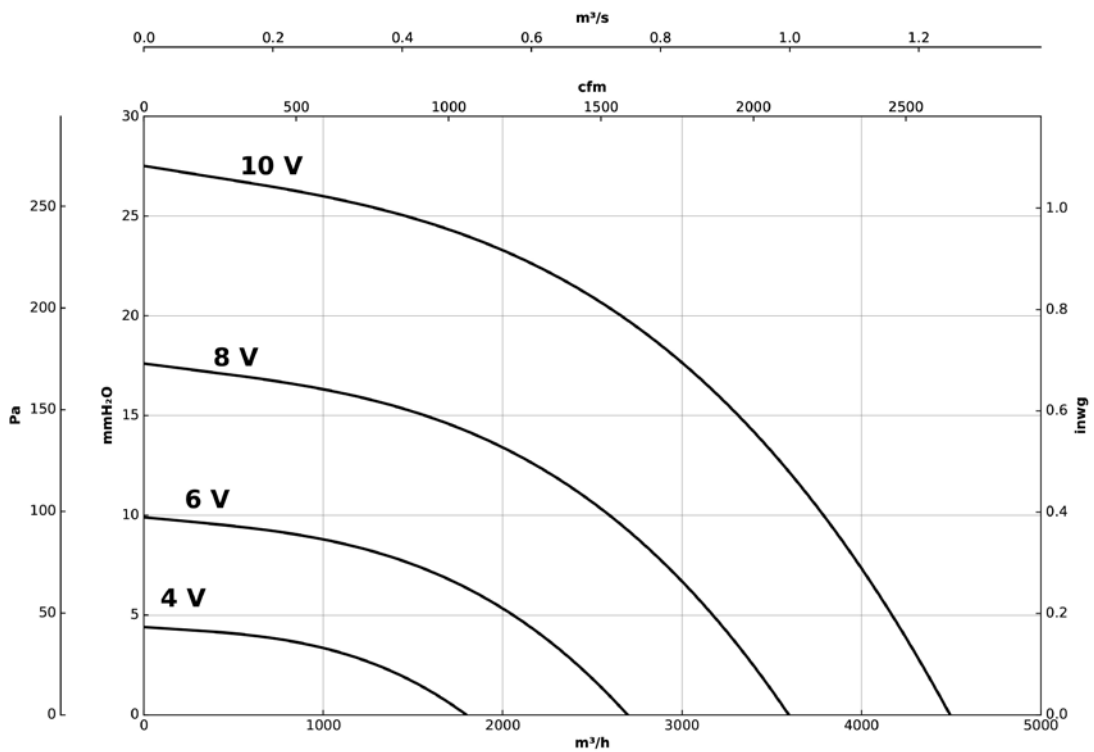

## Characteristic curves

Q= Flow rate in m<sup>3</sup>/h, m<sup>3</sup>/s and cfm

Pe= Static pressure in mm H<sub>2</sub>O, Pa and inwg

### CHT/EC-450-6M

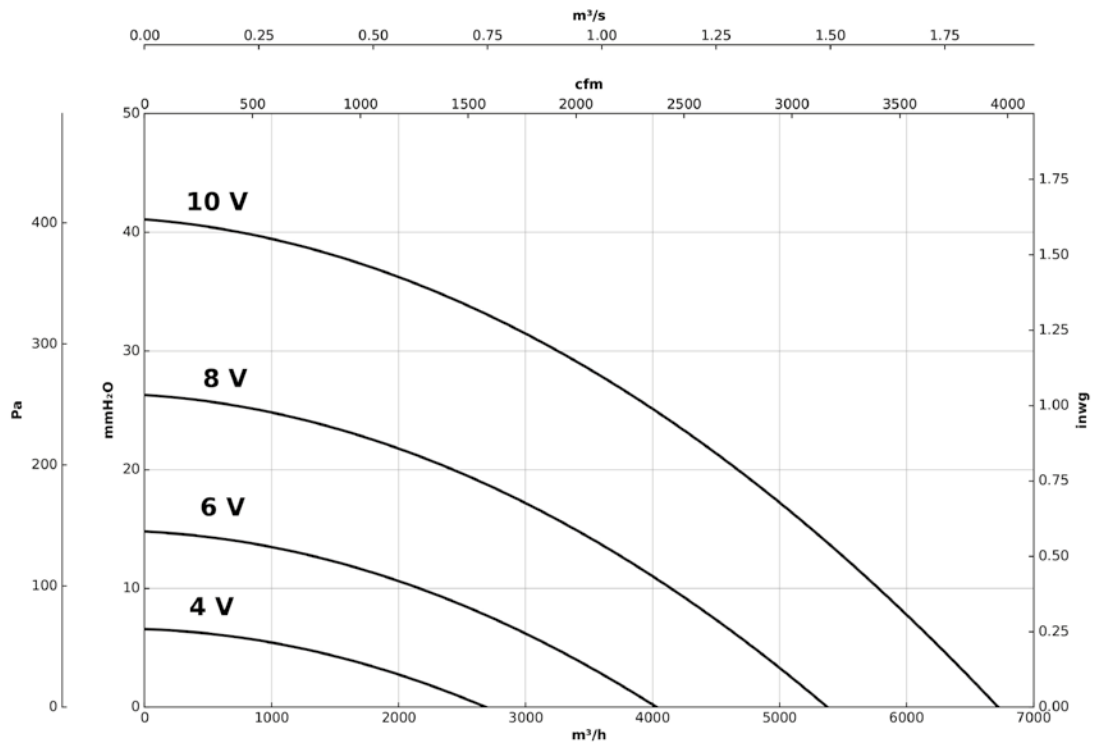

## Accessories

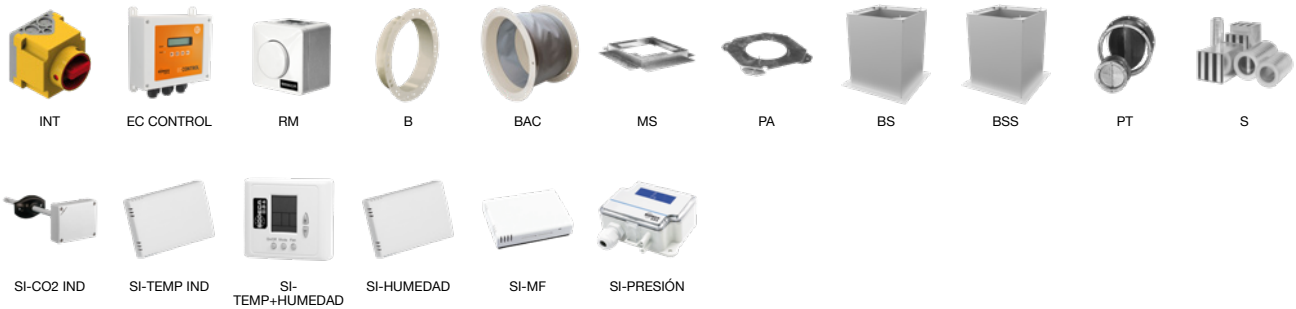

# CVT/EC

Centrifugal roof fans with vertical air outlet, with EC Technology IE5 motor



#### Fan:

- Support base in galvanized steel sheet.
- Backward curved impeller made of galvanized sheet steel.
- Bird protection grid.
- Aluminum rain cover.
- Airflow direction from motor to impeller.

#### Motor:

- High efficiency EC Technology motors with integrated electronics, regulated by 0-10 V or 4-20 mA.
- IE5 efficiency motors, class F and IP55 protection.
- Single-phase 230 V 50/60 Hz.
- Working temperature: -25 °C +60 °C.

- External sensor: compatible with temperature, humidity, air quality or CO sensor.
- Equipment preconfigured in constant pressure mode with 100 Pa set point.

#### Finish:

- Anti-corrosive in galvanized steel sheet and aluminum.



← EC TECHNOLOGY MOTOR with integrated electronics



← EC CONTROL Supplied as an optional accessory

EC CONTROL: Supplied as an optional accessory. Control panel for ventilation systems with EC Technology motors with the electronics integrated in the motor itself. With the following characteristics:

- CPC: Constant pressure control.
- CFC: Constant flow control.
- DAY / NIGHT: Double pressure setpoint adjustment according to time of day.

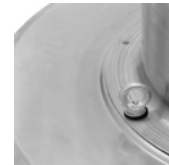

Support for roof-mounting



## Order code

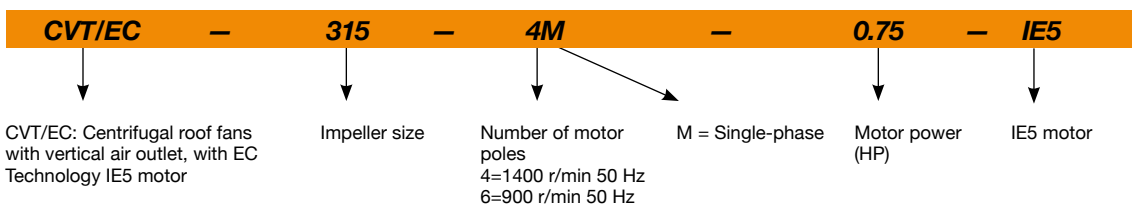

## Technical characteristics

Model	Speed (r/min)	Maximum admissible current (A)	Max. electric power (kW)	Maximum flow rate (m³/h)	Sound pressure level dB (A)		Approx. weight (Kg)	According ErP
		230V			Inlet	Exhaust		
CVT/EC-315-4M-0.75 IE5	1380	4.8	0.55	4950	48	54	39	2018
CVT/EC-400-6M-0.55 IE5	900	3.4	0.37	4500	44	50	56	2018
CVT/EC-450-6M-0.55 IE5	900	3.4	0.37	6900	47	54	59	2018



## Erp. (Energy Related Products)

Information on Directive 2009/125/EC can be downloaded from the SODECA website or the QuickFan selector programme.

### Acoustic characteristics

The indicated values are determined by measuring the sound pressure level and sound power in dB(A) obtained in a free field at a distance equivalent to twice the size of the fan plus the impeller diameter, with a minimum of 1.5 m.

#### Sound power spectrum Lw(A) in dB(A) per Hz frequency band

##### Values measured at inlet with maximum flow rate (Qmax)

	63	125	250	500	1000	2000	4000	8000
315-4M	50	56	62	62	65	68	59	53
400-6M	46	52	58	58	61	64	55	49
450-6M	50	57	62	62	66	65	58	53

##### Values measured at exhaust with maximum flow rate (Qmax)

	63	125	250	500	1000	2000	4000	8000
315-4M	49	61	69	71	72	72	84	58
400-6M	45	57	65	67	68	68	60	52
450-6M	50	62	70	72	73	70	63	55

### Dimensions mm

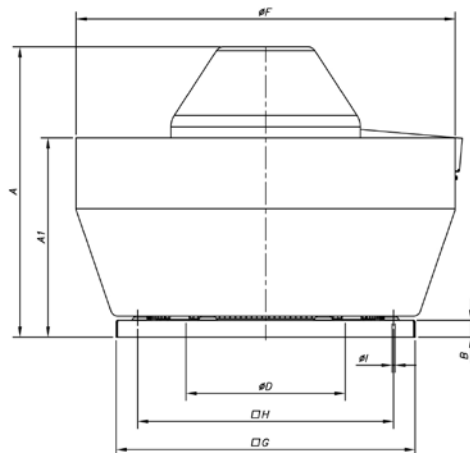

	A	A1	B	øD*	øF	G	H	øl
CVT/EC-315-4M	612	373	30	355	700	560	450	12
CVT/EC-400-6M	689	473	40	500	900	710	590	12
CVT/EC-450-6M	705	474	40	500	900	710	590	12

\* Recommended nominal tube diameter

### Characteristic curves

Q= Flow rate in m<sup>3</sup>/h, m<sup>3</sup>/s and cfm

Pe= Static pressure in mm H<sub>2</sub>O, Pa and inwg

#### CVT/EC-315-4M

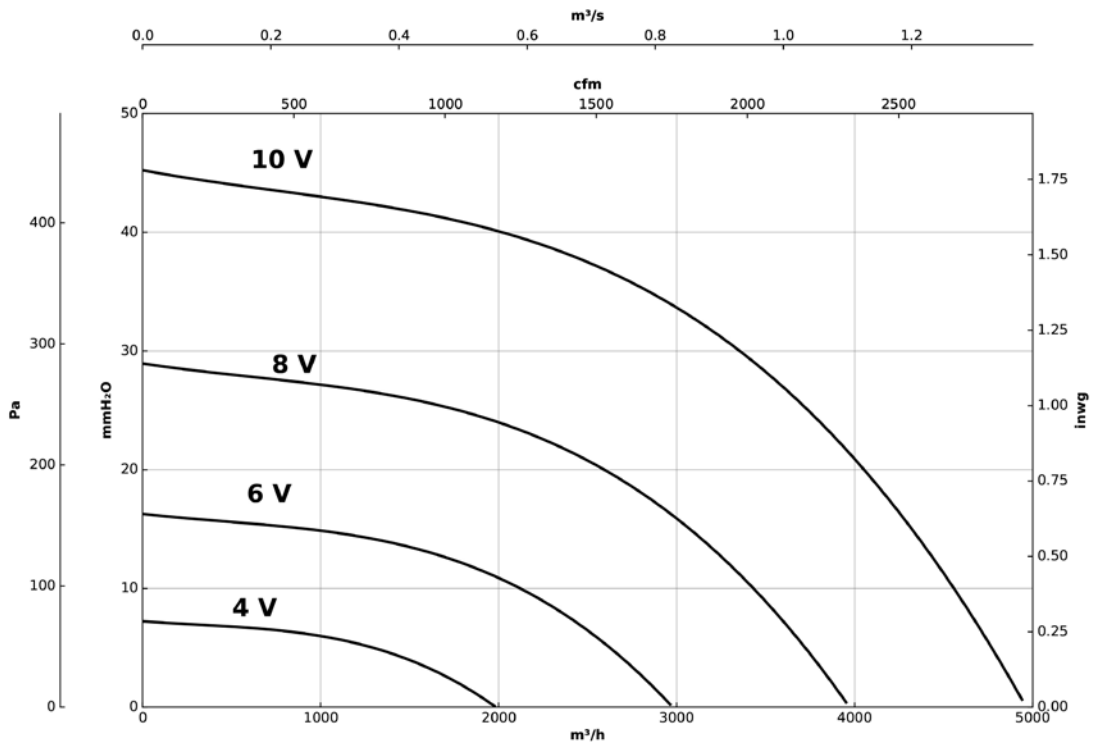

#### CVT/EC-400-6M

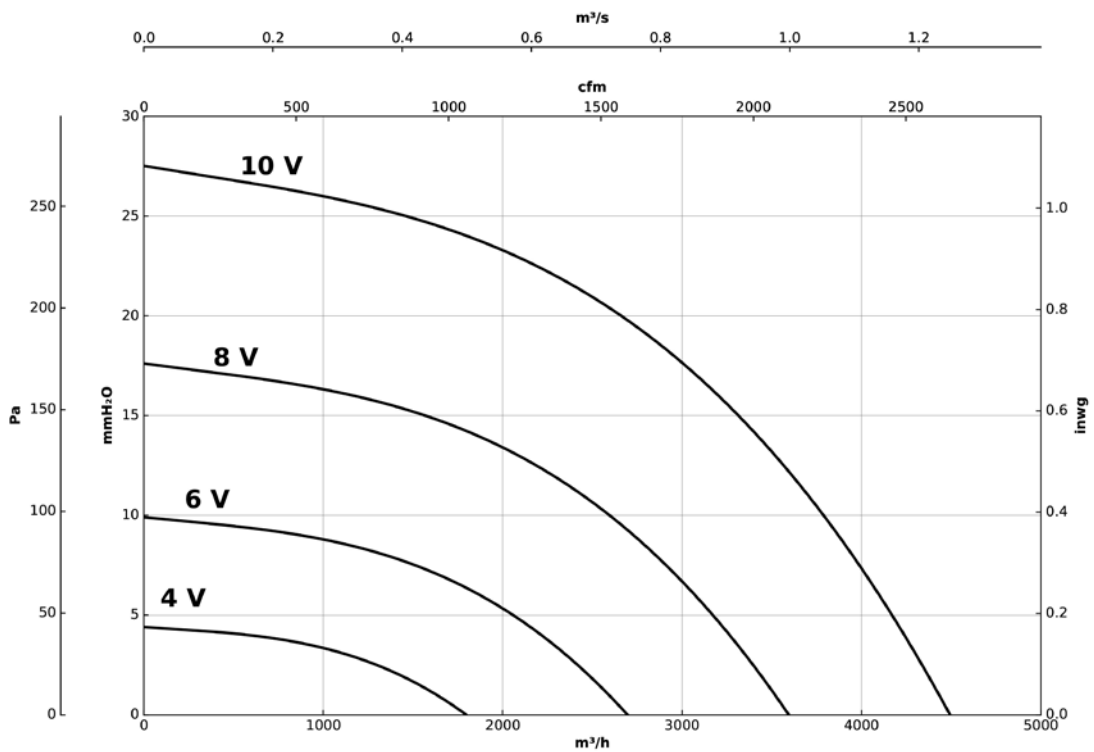



## Characteristic curves

Q= Flow rate in m<sup>3</sup>/h, m<sup>3</sup>/s and cfm

Pe= Static pressure in mm H<sub>2</sub>O, Pa and inwg

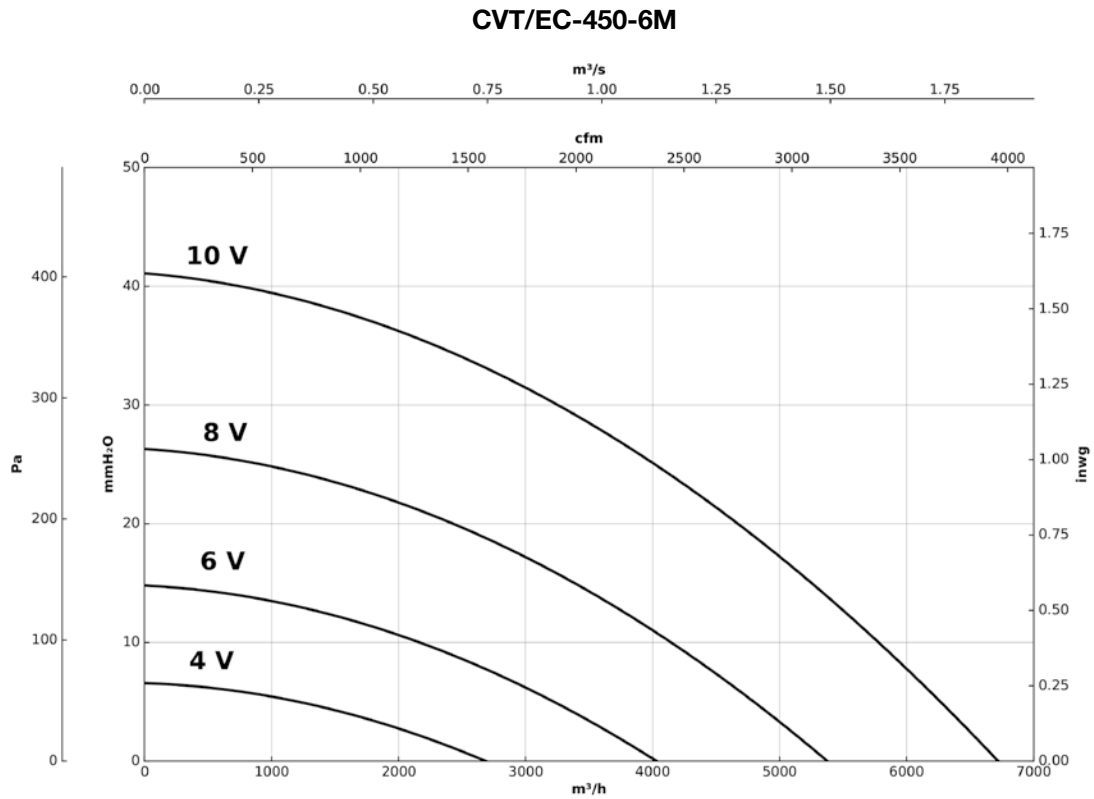

## Accessories

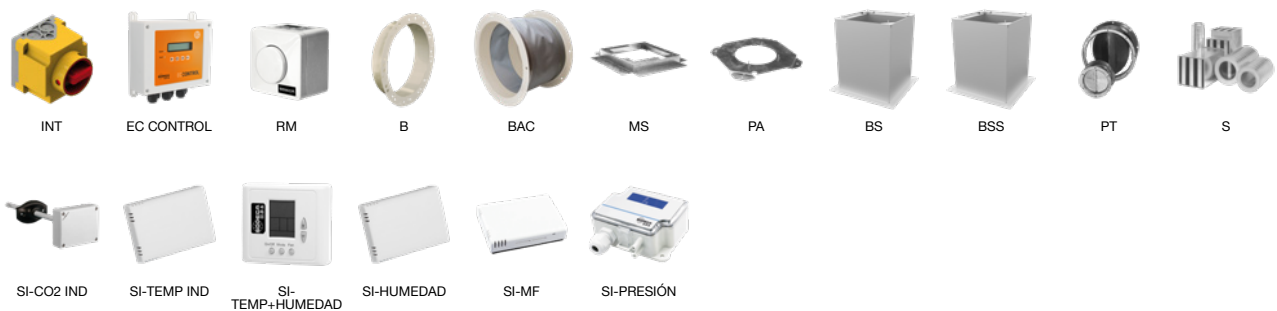

# EC CONTROL



*Automatic regulation and control panel for ventilation systems with EC Technology motors*



Control panel for ventilation systems with EC Technology motors with the electronics integrated in the motor itself. The EC CONTROL system incorporates all the necessary functions for the automatic regulation of the VMC controlled mechanical ventilation system, adjusting the fan speed parameters according to the desired air renewal and air quality parameters.

Easy system configuration via pushbutton control panel and LCD screen or via USB port using our free Sodeca CPC Utility software. Equipment preconfigured in constant pressure mode with 100 Pa set point.

The EC CONTROL panel includes:

- Built-in high precision differential pressure sensor.
- LCD screen and controls for programming all functions.
- Modbus RTU connection for BMS systems.

- USB port for quick configuration via PC.
- Configurable 0-10 V and 4-20 mA analog inputs for connection of external sensors: °C, VOC, CO, Humidity ...
- Casing with IP54 protection rating.
- Working temperature range -10 °C +50 °C.
- Power supply 230 VAC 50/60 Hz.
- Digital inputs to activate and stop the system and DAY / NIGHT function.
- Potential free relay outputs: run and fault.

Control modes:

- CPC: Constant pressure control.
- CFC: Constant flow control.
- DAY / NIGHT: Double pressure setpoint adjustment according to time of day.
- External sensor: compatible with temperature, humidity, air quality or CO2 sensor.

## Technical characteristics

Model	Supply voltage	Nominal current	Control output	Pressure range	Operating temperature	Approx. weight	Protection class
	(V)	(A)	(V)	(Pa)	(°C)	(Kg)	
EC CONTROL	230 V AC 50/60 Hz	0.6	0-10	0-2500	-10 a +50	0.9	IP54

## Dimensions mm

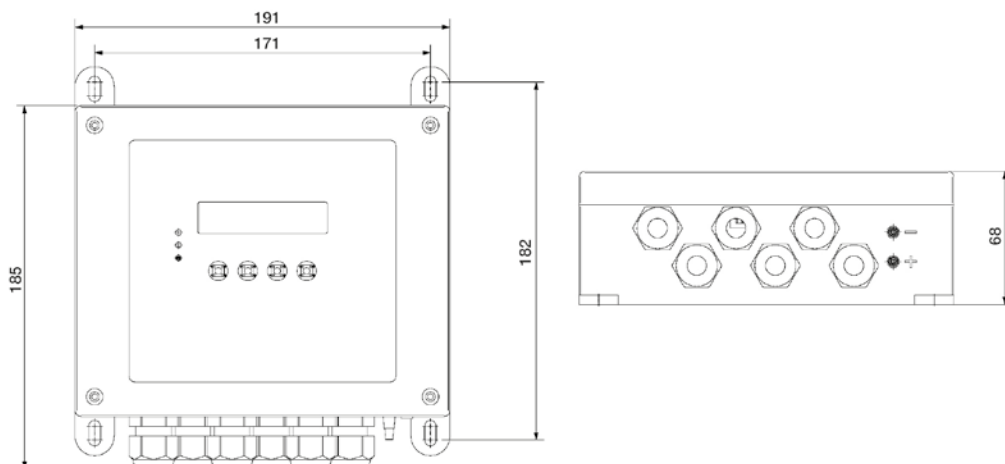

## Connections

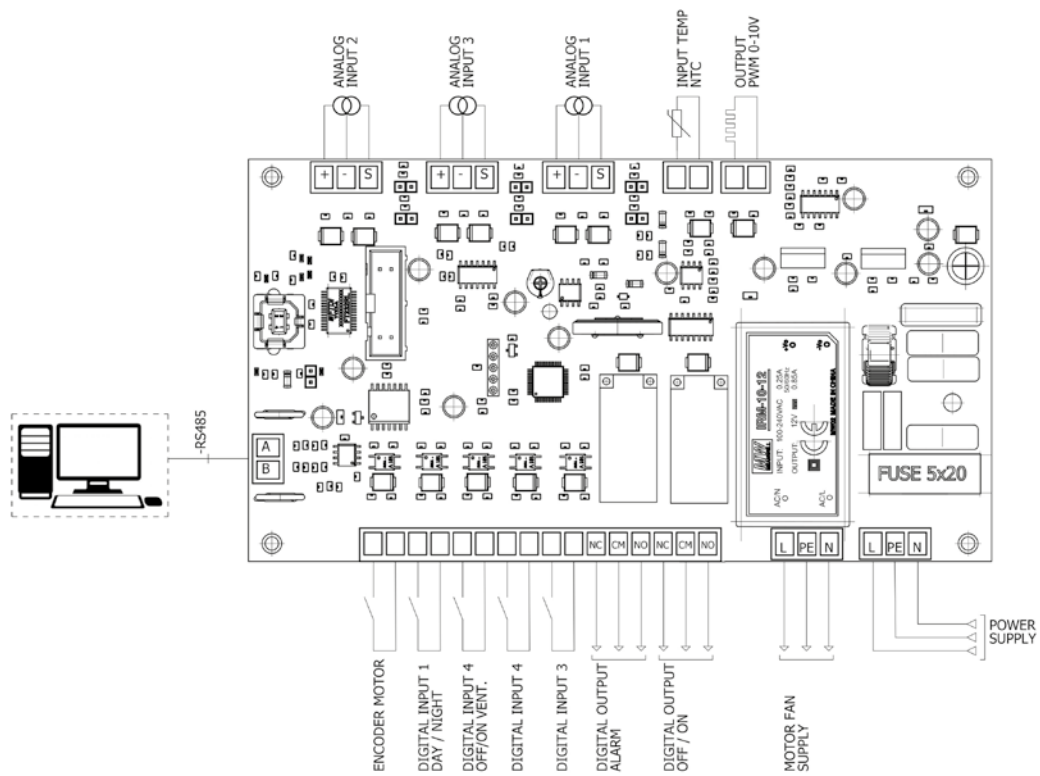

## Accessories



SI-  
TEMP+HUMEDAD

# CAP/EC

*Intelligent control for the regulation of equipment with EC Technology fans prepared for external air quality probes*



Intelligent control designed for automatic or manual operation of EC Technology fans.

Characteristics of the main unit:

- LCD display with LED Backlight.
- Manual set point regulation 0-10 V.
- Automatic regulation 0-10 V set point according to probe reading.
- Built-in temperature and humidity sensors.
- Remote safety stop.
- Disinfection system ON/OFF.
- Filter maintenance alarm.
- Disinfection system maintenance alarm.
- Time programming.
- Modbus RTU communications channel.
- Mounted on the wall or on the fan itself.
- Power supply 230 V 50 Hz.
- Inputs:

- 2 analogue inputs 0-10 V for PM2.5 sensors, VOC or CO2.
- 1 input for filter status pressure switch voltage-free contact.
- 1 input for remote stop voltage-free contact.
- Outputs:
- 1 output 0-10 V regulation of EC Technology motor.
- 1 disinfection system actuation voltage-free contact.

Intelligent sensors:

- LED air status indicator.
- Wall-mounted.
- Power supply 230 V 50 Hz.
- Available options:
- PM2.5+VOC: For air recirculating installations.
- CO2+VOC: For air renewal installations.

## Technical characteristics

Model	Regulation type				
	Temperature	Relative Humidity	PM2.5	CO <sub>2</sub>	VOC
CAP/EC	OK	OK	-	-	-
CAP/EC con PM2.5+VOC	OK	OK	OK	-	OK
CAP/EC con CO <sub>2</sub> +VOC	OK	OK	-	OK	OK

## Dimensions mm

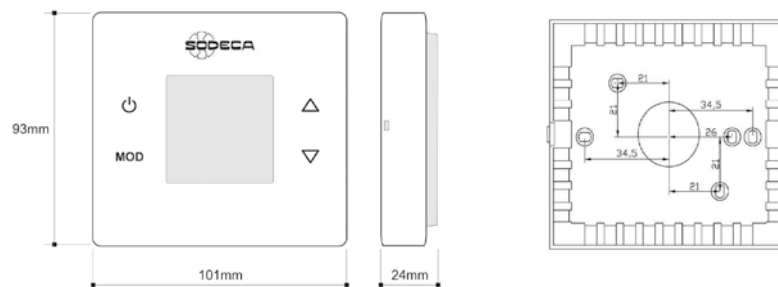

# SI-PM2.5+VOC

*Intelligent probe for CAP/EC control, for the regulation of ventilation based on the parameters of solid particles and volatile organic compounds*

## Dimensions mm

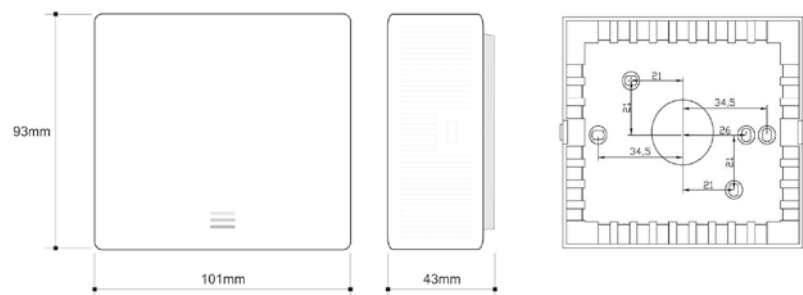

# SI-CO2+VOC

*Intelligent probe for CAP/EC control, for the regulation of ventilation based on CO2 and volatile organic compounds parameters*

## Dimensions mm

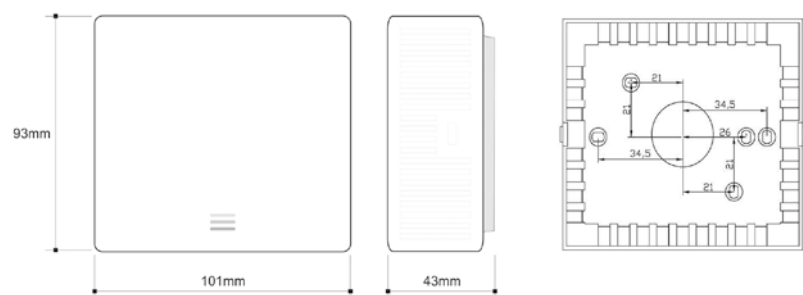

# MTP

*Brushless motor speed control 0-10 V*



Characteristics:

- Potentiometer for speed control of fans equipped with 0-10 VDC brushless motor.
- Gradually delivers a voltage of between 0 and 10 VDC.
- Can be used as a switch.
- Moisture resistant body.
- Possibility of surface or recessed mounting.



## HEADQUARTER

**Sodeca, S.L.U.**  
Pol. Ind. La Barricona  
Carrer del Metall, 2  
E-17500 Ripoll  
Girona, SPAIN  
Tel. +34 93 852 91 11  
Fax: +34 93 852 90 42  
General sales:  
comercial@sodeca.com  
Export sales:  
ventilation@sodeca.com

## PRODUCTION PLANT

**Sodeca, S.L.U.**  
Ctra. de Berga, km 0,7  
E-08580 Sant Quirze de  
Besora  
Barcelona, SPAIN  
Tel. +34 93 852 91 11  
Fax: +34 93 852 90 42  
General sales:  
comercial@sodeca.com  
Export sales:  
ventilation@sodeca.com



## EUROPE

### FINLAND

**Sodeca Finland, Oy**  
HUITTINEN  
Sales and Warehouse  
Mr. Kai Yli-Sipilä  
Metsälinnankatu 26  
FI-32700 Huitinen  
Tel. + 358 400 320 125  
orders.finland@sodeca.com

HELSINKI  
Smoke Control Solutions  
Mr. Antti Kontkanen  
Viilppulantie 9C  
FI-00700 Helsinki  
Tel. +358 400 237 434  
akontkanen@sodeca.com

HYVINKÄÄ  
Industrial Applications  
Mr. Jaakko Tomperi  
Niinistökatu 12  
FI-05800 Hyvinkää  
Tel. +358 451 651 333  
jtomperi@sodeca.com

### ITALIA

**Marelli Ventilazione, S.R.L.**  
Viale del Lavoro, 28  
37036 San Martino B.A.  
(VR), ITALY  
Tel. +39 045 87 80 140  
vendite@sodeca.com

### PORTUGAL

**Sodeca Portugal, Unip. Lda.**  
PORTO  
Rua Veloso Salgado 1120/1138  
4450-801 Leça de Palmeira  
Tel. +351 229 991 100  
geral@sodeca.pt

LISBOA  
Pq. Emp. da Granja Pav. 29  
2625-607 Vialonga  
Tel. +351 219 748 491  
geral@sodeca.pt

ALGARVE  
Rua da Alegria, 33  
8200-569 Ferreiras  
Tel. +351 289 092 586  
geral@sodeca.pt

### UNITED KINGDOM

**Sodeca Fans UK, Ltd.**  
Mr. Mark Newcombe  
Tamworth Enterprise Centre  
Philip Dix House, Corporation  
Street, Tamworth, B79 7DN  
UNITED KINGDOM  
Tel. +44 (0) 1827 216 109  
sales@sodeca.co.uk

## AMERICA

### CHILE

**Sodeca Ventiladores, SpA.**  
Sra. Sofía Ormazábal  
Santa Bernardita 12.005  
(Esquina con Puerta Sur)  
Bodegas 24 a 26,  
San Bernardo, Santiago, CHILE  
Tel. +56 22 840 5582  
ventas.chile@sodeca.com

### COLOMBIA

**Sodeca Latam, S.A.S.**  
Sra. Luisa Stella Prieto  
Calle7 No. 13 A-44  
Manzana 4 Lote1, Montaña  
Mosquera, Cundinamarca  
Bogotá, COLOMBIA  
Tel. +57 1 756 4213  
ventascolombia@sodeca.co

### PERU

**Sodeca Perú, S.A.C.**  
Sr. Jose Luis Jiménez  
C/ Mariscal Jose Luis de  
Orbegoso 331. Urb. El pino.  
15022, San Luis. Lima, PERÚ  
Tel. +51 1 326 24 24  
Cel. +51 994671594  
comercial@sodeca.pe



#### HEADQUARTER

##### Sodeca, S.L.U.

Pol. Ind. La Barricona  
Carrer del Metall, 2  
E-17500 Ripoll  
Girona, SPAIN  
Tel. +34 93 852 91 11  
Fax: +34 93 852 90 42  
General sales: [comercial@sodeca.com](mailto:comercial@sodeca.com)  
Export sales: [ventilation@sodeca.com](mailto:ventilation@sodeca.com)

#### PRODUCTION PLANT

##### Sodeca, S.L.U.

Ctra. de Berga, km 0,7  
E-08580 Sant Quirze de Besora  
Barcelona, SPAIN  
Tel. +34 93 852 91 11  
Fax: +34 93 852 90 42  
General sales: [comercial@sodeca.com](mailto:comercial@sodeca.com)  
Export sales: [ventilation@sodeca.com](mailto:ventilation@sodeca.com)



[www.sodeca.com](http://www.sodeca.com)

