



NEOLINEO



CA/LINE



EDMF



ECONOMIC



COMMERCIAL VENTILATION



According
EU Regulation



OUR COMMITMENT TO THE ENVIRONMENT

Sodeca has begun a new stage of study and design of new trends in ventilation which will help to preserve the environment and to make the energy saving which so much concerns today's society.



In order to obtain an improvement in the energetic consumption, SODECA has adjusted the impellers in the maximum efficiency working area. For this reason there might be changes in the curves of this catalogue compared to previous editions.

SODECA has concentrated its activity on the production of industrial fans, ventilation systems and extractors for the removal of smoke in case of fire since 1983, when it was founded.

SODECA's fans and extractors are present in all European countries and in many parts of the world, thanks to the quality of the product and the methods of research and development used.

Our quality procedures used and certified by BUREAU VERITAS, in accordance with ISO 9001:2008, are another of the reasons which make **SODECA** one of the best and most renowned fan manufacturers in Europe.

Without a doubt, the most important factor to achieve our objectives is the human factor, the great professionals who work at your service, offering not only ventilation equipment but also solutions to any ventilation need required by our customers.

We sincerely offer you the possibility of visiting our facilities in Sant Quirze de Besora, with over 16,000 square metres of built area, where you will be able to see our fan manufacture with perfect clarity and with the highest standards of quality, complying with the ISO and AMCA standards.

This catalogue is only a small part of our possibilities. Do not hesitate to contact us. We will put all our experience and our human resources at your disposal.



*Installations
headquarters of
SODECA s.a.,
at Sant Quirze
de Besora and
manufacturing plant
in Santiago
de Chile.*

AXIAL FANS
AND
ROOF FANS



CENTRIFUGAL FANS
AND IN-LINE EXTRACTORS



FANS FOR
SMOKE
EXTRACTION



ATEX FANS FOR
EXPLOSIVE ATMOSPHERES
AND OTHER APPLICATIONS



NEW SERIES - NEW PRODUCTS

NEW CATALOGUES



NEW BUSINESS OPPORTUNITIES

LOW-PRESSURE
CENTRIFUGAL FANS



HEAT RECOVERY
SYSTEMS AND
FILTRATION UNITS



AIR CURTAINS FOR
COMMERCIAL AND
INDUSTRIAL APPLICATIONS



VENTILATION SYSTEM
FOR HOUSES
AND FLATS



Ask us for
information



Crta. de Berga, km 0,7
E-08580 St. Quirze de Besora
BARCELONA (Spain)
Tel. +34 93 852 91 11
Fax.+34 93 852 90 42

comercial@sodeca.com
Export sales: ventilation@sodeca.com
www.sodeca.com





FULFILMENT OF STANDARDS

SODECA's fans and extractors comply with the following standards:

QUALITY	
ISO 9001:2008	Sistemas de gestión de la calidad. Requisitos. Quality management systems -- Requirements
TESTS	
ISO 5801	Ventiladores industriales. Industrial fans -- Performance testing using standardized airways Industrial fans -- Performance testing using standardized airways
AMCA 210-99	Ventiladores industriales. Métodos de ensayos de ventiladores y su representación de ensayos. Laboratory Methods of Testing Fans for Aerodynamic Performance Rating
UNE 100212:1990	Ventiladores. Dispositivos e instalaciones para el ensayo de ventiladores.
ISO 13350	Ventiladores industriales. Ensayos de comportamiento de ventiladores de chorro. Industrial fans -- Performance testing of jet fans
ISO 13348	Industrial fans -- Tolerances, methods of conversion and technical data presentation
FANS FOR HIGH TEMPERATURES	
EN 12101-3:2002	Sistemas de control de humos y calor. Parte 3: Especificaciones para aireadores extractores de humos y calor mecánicos. Smoke and heat control systems - Part 3: Specification for powered smoke and heat exhaust ventilators
ACOUSTICS	
ISO 3744	Acústica. Determinación de los niveles de potencia acústica de fuentes de ruido a partir de la presión acústica. Método de ingeniería para condiciones de campo libre sobre un plano reflectante. Acoustics -- Determination of sound power levels of noise sources using sound pressure -- Engineering method in an essentially free field over a reflecting plane
BALANCE AND VIBRATIONS	
ISO 1940-1	Vibraciones mecánicas. Calidad de equilibrado Mechanical vibration -- Balance quality requirements for rotors in a constant (rigid) state -- Part 1: Specification and verification of balance tolerances
ISO 10816-1	Vibraciones mecánicas. Evaluación de las vibraciones de máquinas Mechanical vibration -- Evaluation of machine vibration by measurements on non-rotating parts -- Part 1: General guidelines
ISO 14694	Ventiladores industriales. Especificaciones para equilibrado y niveles de vibración Industrial fans -- Specifications for balance quality and vibration levels
SAFETY (Declaration of EC Compliance)	
EN ISO 12100-1	Seguridad de las máquinas. Conceptos básicos, principios generales para el diseño. Parte 1: Terminología básica, metodología. Safety of machinery -- Basic concepts, general principles for design -- Part 1: Basic terminology, methodology
EN ISO 12100-2	Seguridad de las máquinas. Conceptos básicos, principios generales para el diseño. Parte 2: Principios técnicos. Safety of machinery -- Basic concepts, general principles for design -- Part 2: Technical principles
EN 60204-1	Seguridad de las máquinas. Equipo eléctrico de las máquinas. Parte 1: Requisitos generales. Safety of machinery - Electrical equipment of machines - Part 1: General requirements
EN 294	Seguridad de máquinas. Distancias de seguridad para impedir que se alcancen zonas peligrosas con los miembros superiores Safety of machinery; safety distances to prevent danger zones from being reached by the upper limbs
ISO 13857	Seguridad de máquinas. Distancias de seguridad para impedir que se alcancen zonas peligrosas con los miembros superiores e inferiores. Safety of machinery -- Safety distances to prevent danger zones being reached by upper and lower limbs
UNE 100250	Ventiladores industriales. Seguridad mecánica de los ventiladores (equivalente ISO 12499)
ISO 12499	Ventiladores industriales. Seguridad mecánica en los ventiladores Industrial fans -- Mechanical safety of fans -- Guarding
DIRECTIVES	
Directiva 2006/42/CE	Directiva de máquinas Machinery Directive
Directiva 2006/95/CE	Directiva de baja tensión Low Voltage Directive
Directiva 2004/108/CE	Directiva compatibilidad electromagnética EMC Directive
Directiva 89/106/CE	Directiva productos de construcción Construction Products Directive (CPD)
ATEX EXECUTIONS	
Directiva ATEX 94/9/CE	Aparatos y sistemas de protección para uso en atmósferas potencialmente explosivas Equipment and protective systems intended for use in potentially explosive atmospheres
EN 14986	Diseño de ventiladores para trabajar en atmósferas potencialmente explosivas. Design of fans working in potentially explosive atmospheres
EN 13463-1	Equipos no eléctricos destinados a atmósferas potencialmente explosivas. Parte 1: Requisitos y metodología básica. Non-electrical equipment for use in potentially explosive atmospheres - Part 1: Basic method and requirements
EN 1127-1	Atmósferas explosivas. Prevención y protección contra la explosión. Parte 1: Conceptos básicos y metodología. Explosive atmospheres - Explosion prevention and protection - Part 1: Basic concepts and methodology

VENTILATION SYSTEMS FOR HOUSES AND FLATS

<p>SV SV/PLUS SV/ECO</p>  <p>In-line duct fans 6</p>	<p>CA/LINE</p>  <p>In-line duct fans with Long Life ball bearings 12</p>	<p>NEW CJBC CJBC/ECO</p>  <p>Exhaust fans and compact extraction units for direct operation 15</p>	<p>NEOLINEO</p>  <p>In-line fans for ducts with Long Life ball bearings 18</p>
<p>PLATT</p>  <p>Extractor with multiple inlets/outlets and low silhouette 22</p>	<p>NEW CTD</p>  <p>Centrifugal roof fans for chimney ventilation in houses 24</p>	<p>CA-ROOF</p>  <p>Centrifugal roof fans for chimney ventilation in houses 26</p>	<p>CHRE</p>  <p>Centrifugal roof fans with low noise level 29</p>
<p>RCH RCH-400X800 VM</p>  <p>Fan and chimney top for hybrid extraction in community housing 31</p>	<p>TIRACAMINO</p>  <p>Fans to extract smoke in chimneys and barbecues 34</p>	<p>EDMF</p>  <p>Extra-bathroom extractors, with aesthetic and modern design 35</p>	<p>EDQUIET/S</p>  <p>Domestic extractors very low noise, low power 36</p>
<p>ECONOMIC</p>  <p>Economic air curtains, for small commercial premises 37</p>	<p>RECUP/LC</p>  <p>Configurable heat recuperators 38</p>		



SV SV/PLUS SV/ECO

SV: Low noise in-line duct fans mounted in acoustic casing

SV/PLUS: Low noise in-line duct fans mounted in acoustic casing with 50mm insulation

SV/ECO: Low noise in-line duct fans mounted in acoustic casing with 50 mm insulation, fitted with EC motors



SV



SV/PLUS



SV/ECO

Fan:

- Acoustic casing covered with deadening material
- SV: Impeller with backward-curved blades, except models 125-150-200, with multi-blade impeller
- SV/PLUS: Multi-blade impeller for all models
- SV/ECO: Backward-curved impeller for all models
- Standard flanged inlet and outlet to aid installation on duct
- They are supplied with 4 base stands to aid installation
- Linear air circulation
- T-models are fitted with 1-5 minute adjustable timer.

Motor:

- Class F motors with external rotor incorporated thermal protector, ball bearings and IP54 protection
- Single-phase 230V.-50/60Hz. adjustable
- Max. air temperature to transport: + 50°C.
- SV/ECO: Highly-efficient brushless-EC motor, electronically controlled by means of a potentiometer of 10KΩ MTP010, or an external signal of 0-10VDC

Finish:

- Anticorrosive finish in polyester resin, polymerised at 190°C, after alkaline degreasing and phosphate-free pre-treatment.

Order code

SV — 150/H — (T)

SV: In-line duct fans

SV/PLUS: In-line duct fans with 50mm insulation.

SV/ECO: In-line fans for ducts with EC motor

Inlet diameter in mm

Airflow level.
H: High airflow
L: Low airflow

T Reference supplied timer

Technical characteristics

Model	Speed (r/min)	Maximum admissible current 230V (A)	Installed power (kW)	Maximum airflow (m³/h)	Irradiated sound level dB(A)	Approx. weight (Kg)
SV-125/H	2720	0.65	0.11	400	32	5.2
SV-125/H-T	2720	0.65	0.11	400	32	5.2
SV-150/H	2580	1.00	0.16	560	40	6.8
SV-150/H-T	2580	1.00	0.16	560	40	6.8
SV-200/H	1400	0.75	0.12	880	44	8.0
SV-200/H-T	1400	0.75	0.12	880	44	8.0
SV-200/L	1450	0.70	0.09	760	42	8.0
SV-250/H	2500	0.85	0.18	1300	48	10.8
SV-250/L	2680	0.75	0.16	1000	46	10.8
SV-315/H	1400	0.65	0.12	2100	50	21.0
SV-350/H	1400	0.95	0.14	2850	51	28.5
SV-400/H	1350	1.80	0.30	3500	53	38.0

Technical characteristics

Model	Speed	Maximum admissible current (A) 230V	Installed power (kW)	Maximum airflow (m³/h)	Irradiated sound level* dB(A)	Approx. weight (Kg)
	(r/min)					
SV/PLUS-125/H	2335	0.33	0.08	260	30	12.0
SV/PLUS-160/H	2480	0.59	0.14	465	36	13.0
SV/PLUS-200/H	1550	0.72	0.17	700	37	17.0
SV/PLUS-250/H	2082	1.15	0.27	1050	38	18.0

* Sound pressure level dB(A) are measurements at a distance of 1.5 meters

Model	Speed	Maximum admissible current (A) 230V	Installed power (kW)	Maximum airflow (m³/h)	Sound pressure level to 50% of max. speed* dB(A)	Approx. weight (Kg)
	(r/min)					
SV/ECO-125/H	4480	0.46	0.055	367	29	12.0
SV/ECO-160/H	3490	0.99	0.114	565	28	19.0
SV/ECO-200/H	3380	1.48	0.192	914	39	24.0
SV/ECO-250/H	3220	1.69	0.213	1107	32	24.0
SV/ECO-315/H	3580	2.8	0.448	1638	49	31.0

* Sound pressure level dB(A) are measurements at a distance of 1.5 meters



Erp. BEP (best efficiency point) characteristics

MC	Measurement category	ηe[%]	Efficiency
EC	Efficiency category	N	Efficiency grade
S	Static	[kW]	Input power
T	Total	[m³/h]	Airflow
VSD	Variable-speed drive	[mmH₂O]	Static or total pressure (According to EC)
SR	Specific ratio	[RPM]	Speed

Model	MC	EC	VSD	SR	ηe[%]	N	(kW)	(m³/h)	(mmH₂O)	(RPM)
SV-125/H	-	-	-	-	-	-	0.118	207	29.9	2768
SV-125/H-T	-	-	-	-	-	-	0.118	207	29.9	2768
SV-150/H	-	-	-	-	-	-	0.125	296	40.3	2761
SV-150/H-T	-	-	-	-	-	-	0.125	296	40.3	2761
SV-200/H	-	-	-	-	-	-	0.102	434	17.1	1438
SV-200/H-T	-	-	-	-	-	-	0.102	434	17.1	1438
SV-200/L	-	-	-	-	-	-	0.113	396	16.0	1463
SV-250/L	-	-	-	-	-	-	0.119	381	38.7	2767
SV-315/H	-	-	-	-	-	-	0.125	991	18.0	1412
SV-350/H	A	S	NO	1.00	43.4%	60.4	0.240	1537	24.9	1401
SV-400/H	A	S	NO	1.00	45.6%	60.6	0.377	1701	37.1	1364
SV/PLUS-125/H	-	-	-	-	-	-	0.064	116	22.96	2368
SV/PLUS-160/H	-	-	-	-	-	-	0.105	231	33.96	2485
SV/PLUS-200/H	-	-	-	-	-	-	0.123	295	28.26	1619
SV/PLUS-250/H	A	S	NO	1.00	27.1%	38.2	0.176	645	27.03	2141
SV/ECO-125/H	-	-	-	-	-	-	0.053	200	20.30	4480
SV/ECO-160/H	-	-	-	-	-	-	0.110	307	48.49	3490
SV/ECO-200/H	A	S	INCLUDED	1.00	47.7%	66.0	0.183	505	55.62	3380
SV/ECO-250/H	A	S	INCLUDED	1.00	47.5%	65.1	0.209	597	53.77	3220
SV/ECO-315/H	A	S	INCLUDED	1.00	48.8%	63.1	0.433	902	77.23	3580

Acoustic features

The specified values are determined according to free field measurements of sound levels in dB(A) at an equivalent distance of twice the fan's span plus the impeller's diameter, with a minimum of 1.5 m.

Sound power Lw(A) spectrum in dB(A) via frequency band in Hz.

Model	63	125	250	500	1000	2000	4000	8000	Model	63	125	250	500	1000	2000	4000	8000
125/H	22	32	36	34	33	34	30	24	SV/PLUS-125/H	35	46	52	57	64	62	55	48
150/H	31	41	42	44	45	46	42	36	SV/PLUS-160/H	43	54	61	66	72	71	67	63
200/H	31	42	47	51	50	47	43	33	SV/PLUS-200/H	43	55	58	62	69	68	66	61
200/L	29	39	46	47	47	46	45	37	SV/PLUS-250/H	49	58	64	70	72	80	70	65
250/H	32	42	47	54	55	53	50	41	SV/ECO-125/H	31	41	54	56	45	45	40	44
250/L	33	43	47	53	51	50	48	41	SV/ECO-160/H	39	49	63	60	49	51	48	46
315/H	34	44	49	56	57	55	52	43	SV/ECO-200/H	42	52	66	60	56	54	51	52
350/H	38	48	52	59	60	58	56	47	SV/ECO-250/H	48	57	70	64	66	59	53	52
400/H	40	50	54	61	62	60	58	49	SV/ECO-315/H	50	59	73	67	68	65	58	55

Dimensions in mm

SV

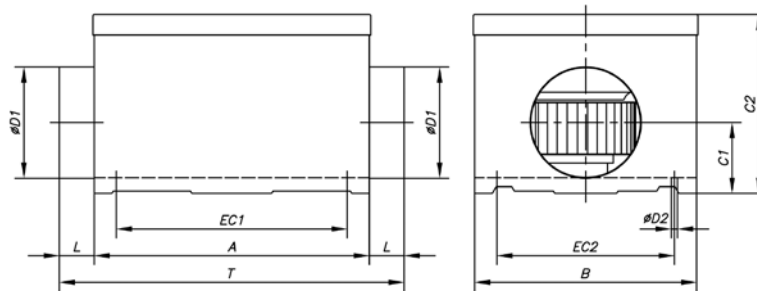

Model	A	B	C1	C2	øD1	L	øD2	EC1	EC2	T
SV-125/H	310	250	80	201	125	36.5	7	260	200	383
SV-150/H	370	290	92	222	150	34.5	7	320	240	439
SV-200/H	430	340	117	246	200	34.5	7	380	290	499
SV-200/L	430	340	117	246	200	34.5	7	380	290	499
SV-250/H	480	395	140	296	250	51.5	7	430	345	583
SV-250/L	480	395	140	296	250	51.5	7	430	345	583
SV-315/H	565	490	173.5	370	315	55	8.5	515	440	675
SV-350/H	650	550	200	410	355	57	8.5	600	500	764
SV-400/H	725	610	200	454	400	70	8.5	675	560	865

SV/PLUS

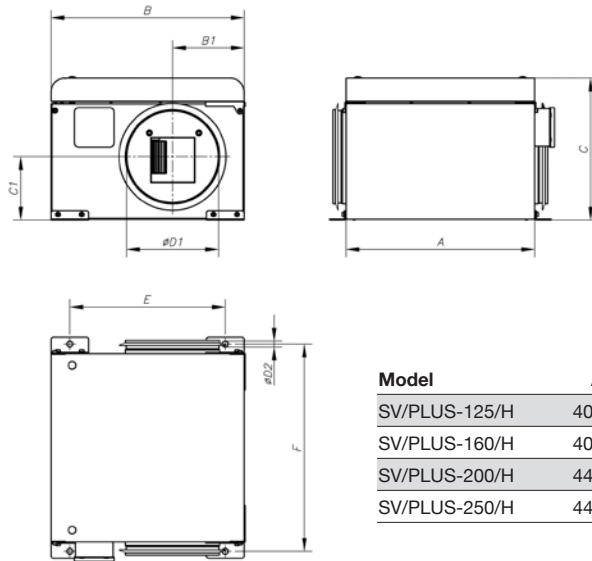

Model	A	B	B1	C	C1	øD1	øD2	E	F
SV/PLUS-125/H	400	410	277	300	171.5	125	12.5	330	440
SV/PLUS-160/H	400	410	148.5	300	142.5	160	12.5	330	440
SV/PLUS-200/H	444	444	222	420	251.5	200	12.5	364	484
SV/PLUS-250/H	444	444	222	420	221.5	250	12.5	364	484

SV/ECO

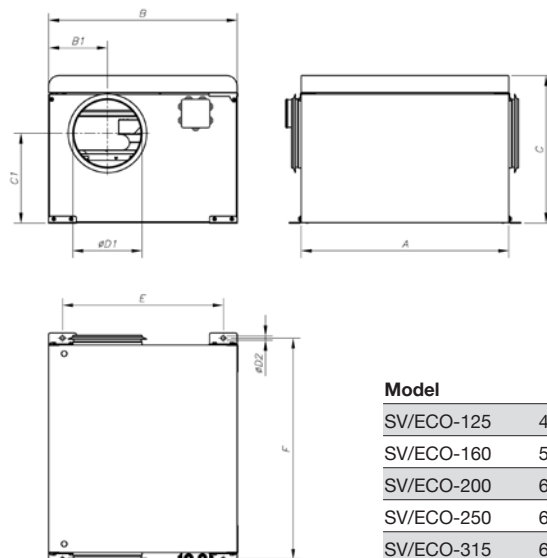

Model	A	B	B1	C	C1	øD1	øD2	E	F
SV/ECO-125	400	410	205	325	165.5	125	12.5	330	440
SV/ECO-160	550	485	149	340	194.5	160	12.5	405	590
SV/ECO-200	600	545	170	425	259.5	200	12.5	465	640
SV/ECO-250	600	545	194	425	234.5	250	12.5	465	640
SV/ECO-315	675	595	227.5	475	251.5	315	12.5	515	715

Characteristic curves

Q = Airflow in m³/h, m³/s and cfm.

Pe = Static pressure in mm.w.c., Pa and inwg.

SV

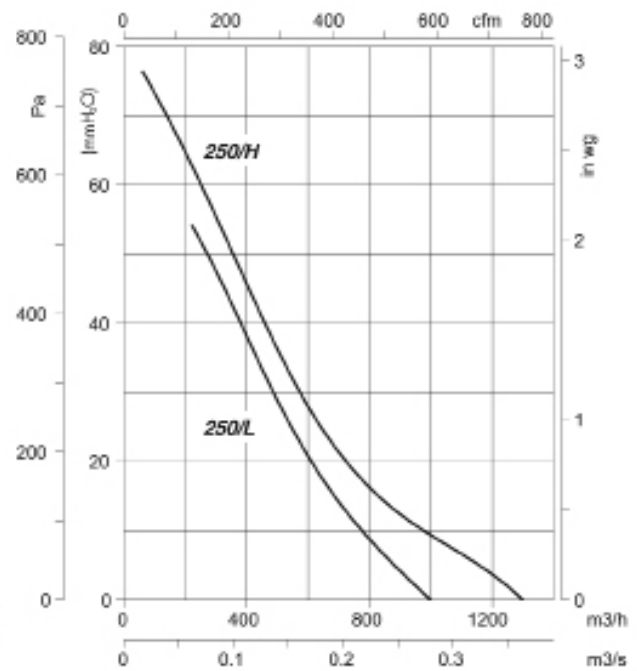
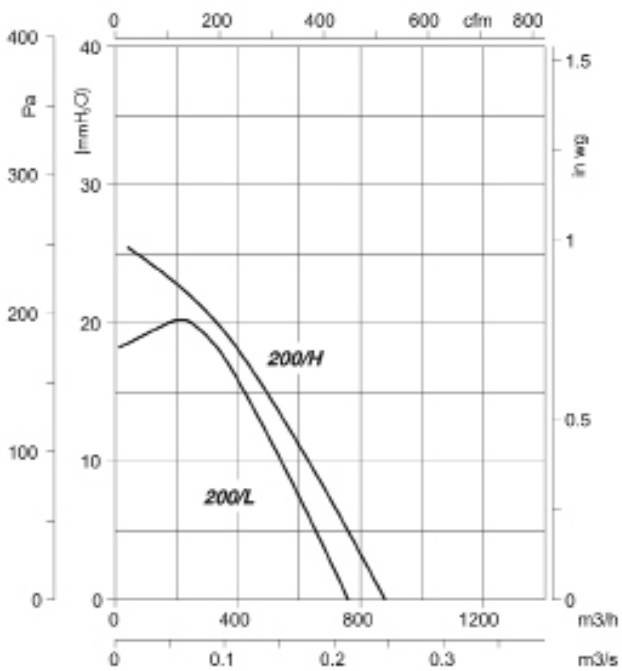
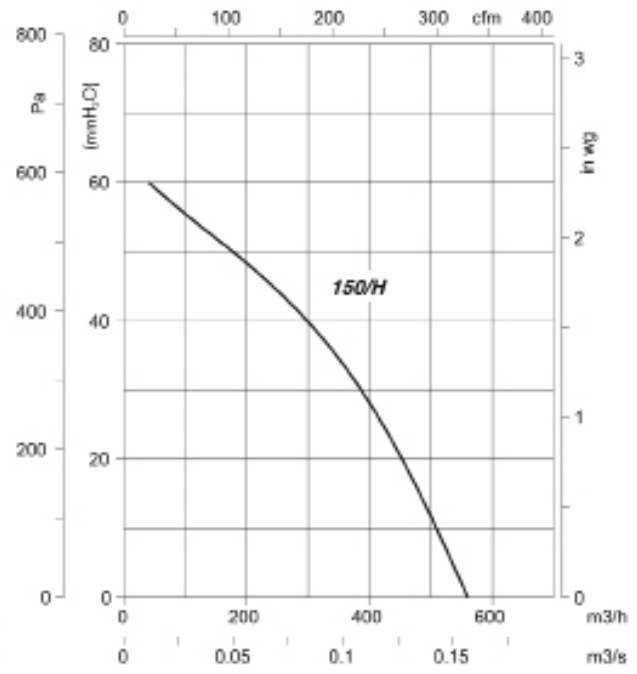
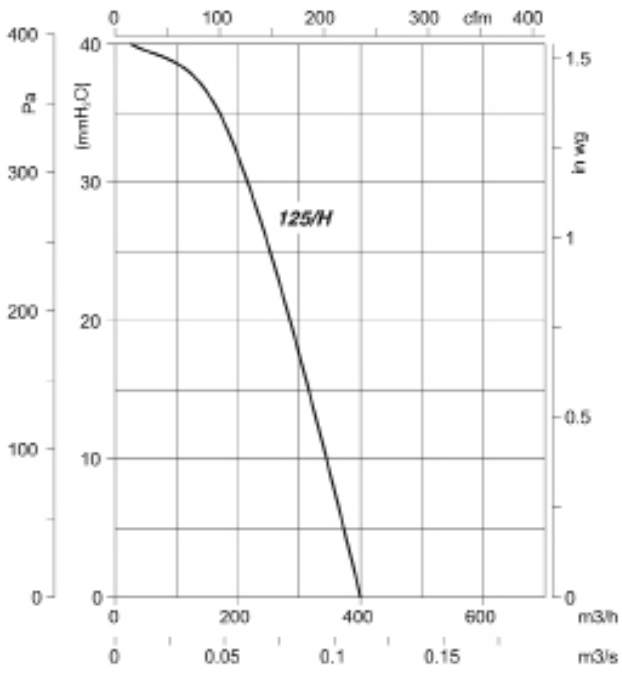

Characteristic curves

Q = Airflow in m³/h, m³/s and cfm.

Pe= Static pressure in mm.w.c., Pa and inwg.

SV

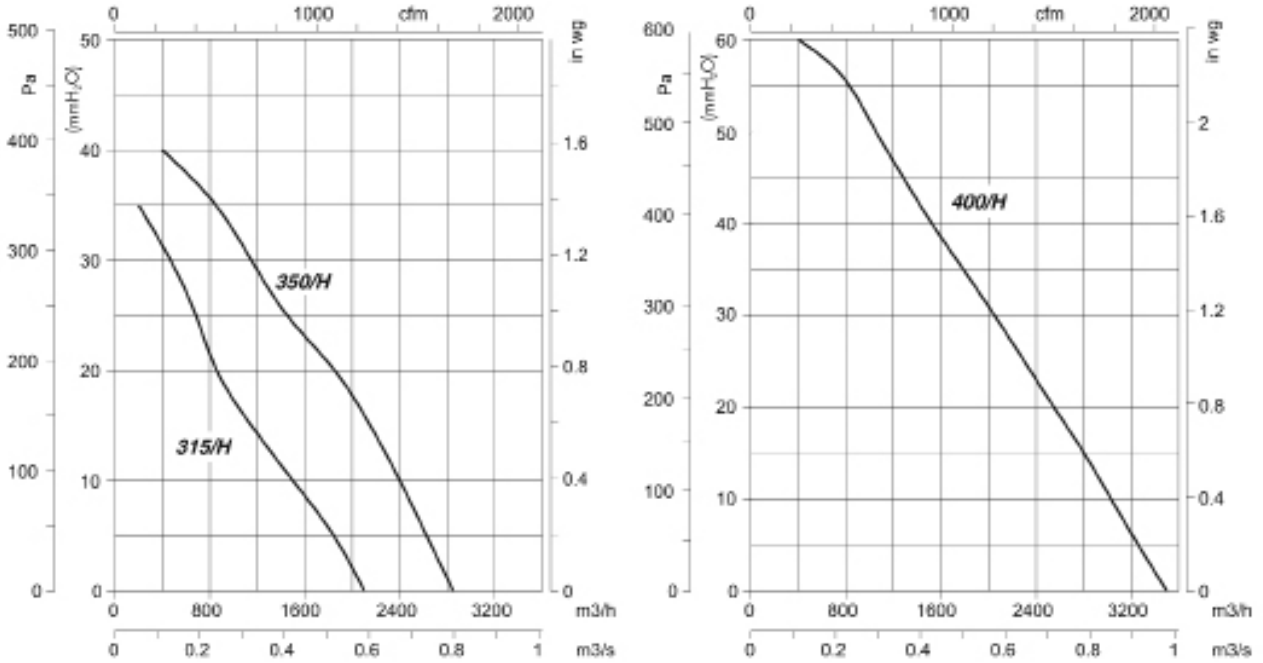

SV/PLUS

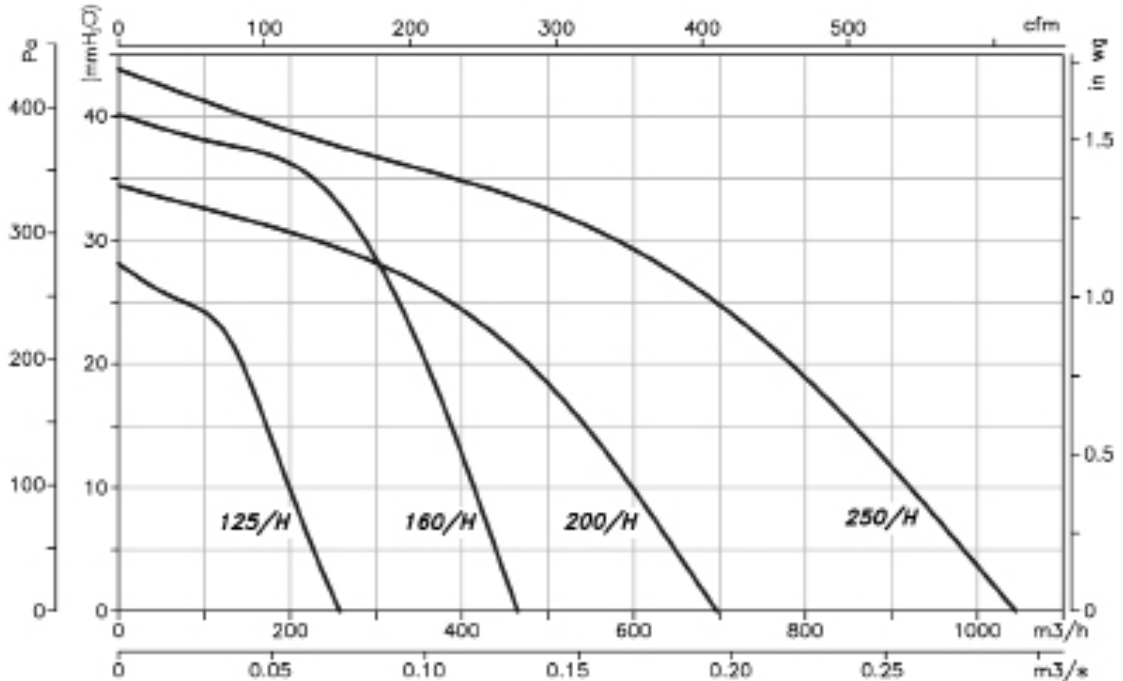

Characteristic curves

Q = Airflow in m³/h, m³/s and cfm.

Pe = Static pressure in mm.w.c., Pa and inwg.

SV/ECO

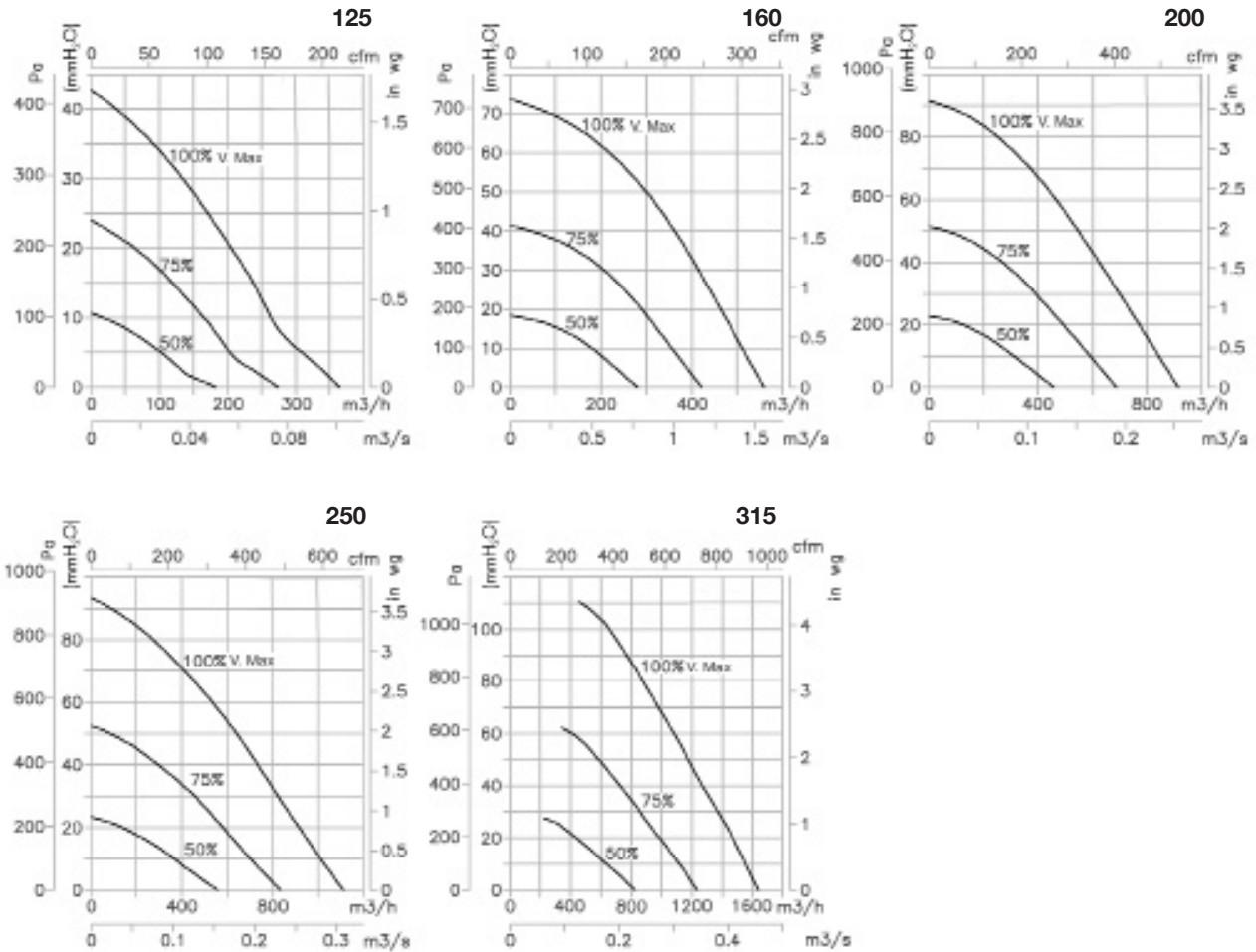

Accessories

See accessories section.



CA/LINE

In-line circular fans for ducts with Long Life ball bearings



- Fan:
- Steel sheet casing
 - External terminal board
 - Quick and easy to install
 - Includes base stand

- Motor:
- Motors with Long Life ball bearings, IPX4 protection, two-speed and adjustable
 - Single-phase 220-240V. 50/60 Hz
 - Working temperature: -10°C +60°C

- Finish:
- Anticorrosive finish in polyester resin, polymerised at 190°C, after alkaline degreasing and phosphate-free pre-treatment



Size 355

Order code

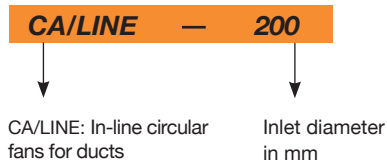

Technical characteristics

Model	Speed (r/min)	Maximum admissible current 230V (A)	Absorbed electrical power (kW)	Maximum Airflow (m ³ /h)	Sound pressure level dB(A)	Approx. weight (Kg)
CA/LINE-10	2460	0.35	0.074	260	33	2.8
CA/LINE-12	2350	0.35	0.075	350	35	2.8
CA/LINE-15	2420	0.44	0.095	537	41	4.8
CA/LINE-20	2600	0.64	0.137	980	36	6.2
CA/LINE-25	2390	0.72	0.157	1008	38	6.6
CA/LINE-31	2378	0.86	0.189	1596	37	6.9
CA/LINE-355	2098	1.56	0.357	2098	39	12

Acoustic features

The specified values are determined according to free field measurements of sound levels in dB(A) at a distance of 3 m.

Sound power Lw(A) spectrum in dB(A) via frequency band in Hz.

Model	63	125	250	500	1000	2000	4000	8000	Model	63	125	250	500	1000	2000	4000	8000
10	7	23	16	33	45	44	37	26	25	14	21	29	36	39	37	38	38
12	8	17	18	34	43	41	33	22	31	12	20	29	36	36	39	38	35
15	10	19	38	40	49	41	40	24	355	12	17	29	37	39	40	39	38
20	11	13	21	35	41	36	46	38									

Dimensions in mm

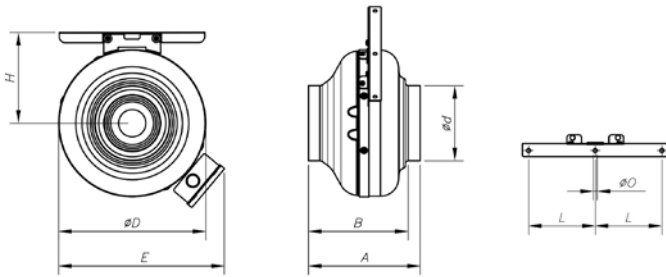

Model	A	B	ød	øD	E	H	L	øO
CA/LINE-10	200	178	100	268	318	141	80	12
CA/LINE-12	200	178	125	268	318	141	80	12
CA/LINE-15	269	244	150	342	392	178	80	12
CA/LINE-20	269	229	200	342	392	178	80	12
CA/LINE-25	279	229	250	342	392	178	80	12
CA/LINE-31	295	245	315	400	450	207	80	12

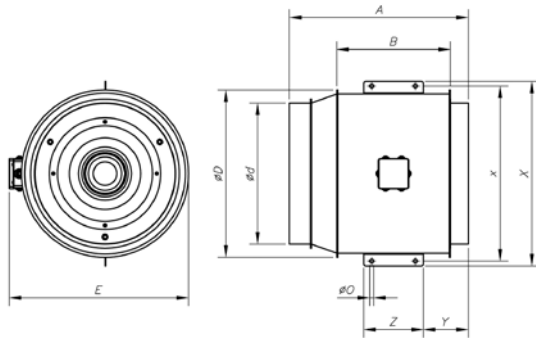

Model	A	B	ød	øD	E	øO	x	X	Y	Z
CA/LINE-355	450	352	354	420	470	10	442	466	135	110

Characteristic Curves

Q = Airflow in m³/h, m³/s and cfm.

Pe = Static pressure in mm.w.c., Pa and inwg.

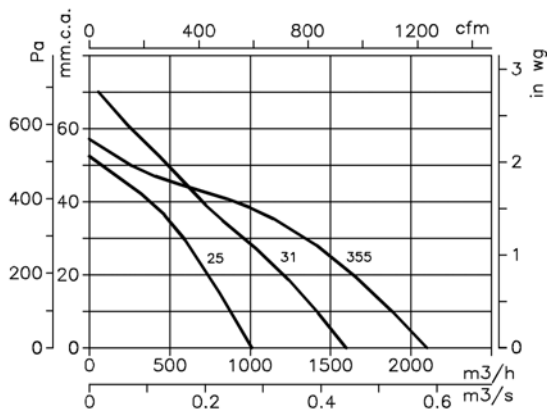
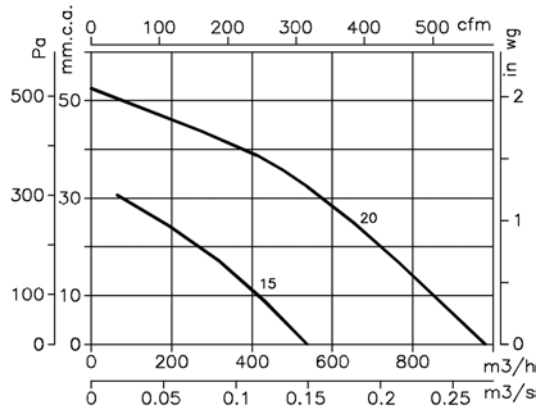
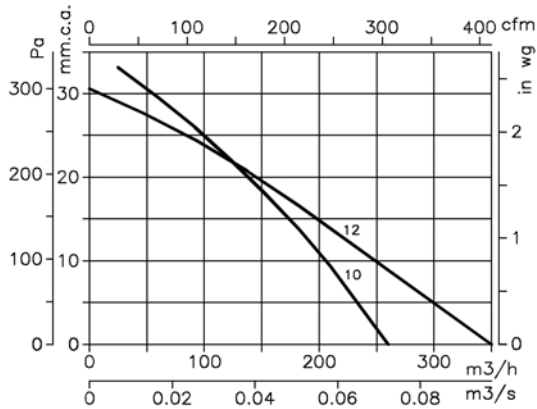

CJBC CJBC/ECO

CJBC: Compact extraction units direct drive for community housing
CJBC/ECO: Compact extraction units direct drive for community housing with constant pressure control

Fan:

- Galvanised sheet steel structure with thermal insulation and soundproofing
- Impeller with forward-facing blades made from galvanised sheet steel
- Stuffing-box for cable inlet
- CJBC/ECO: It incorporates a low-pressure switch and speed regulator by means of a frequency converter to maintain a constant pressure

Motor:

- Class F closed motors with incorporated thermal protector, ball bearings and IP-54 protection
- Single-phase 220-240V.-50Hz. and three-phase 220-240/380-415V.-50Hz
- Max. air temperature to transport: -20°C.+ 60°C

Finish:

- Anticorrosive galvanized sheet steel

On request:

- With circular inlet



CJBC



CJBC/ECO

Example of use

OPTION SELF-REGULATING CONTROL



CJBC



BE ALIZE



EA



OPTION HUMIDITY-SENSITIVE CONTROL



CJBC/ECO



BE ALIZE-H



EA-A-HY

Order code

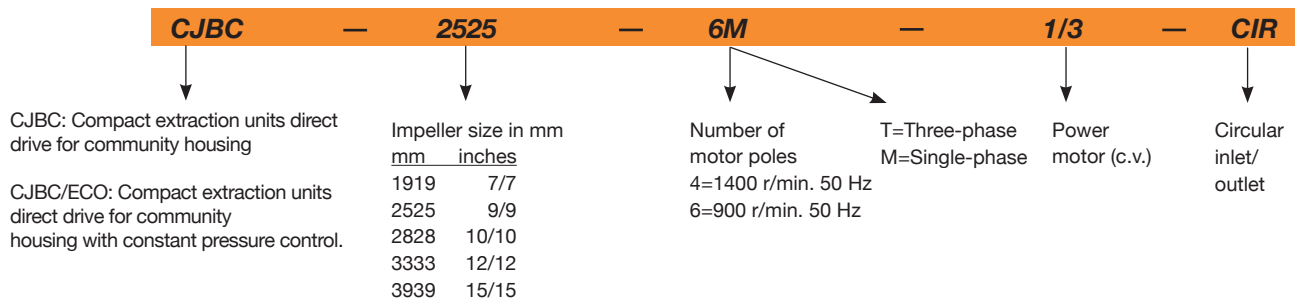

Technical characteristics

Model	Speed (r/min)	Equivalent Inches	Maximum admissible intensity (A)		Installed power (kW)	Maximum Airflow (m³/h)	Sound level dB(A)	Approx. weight (Kg)
			230V	400V				
CJBC-1919-4M 1/5	1230	7/7	1.75		0.15	1368	58	15.7
CJBC-1919-6M 1/10	820	7/7	0.98		0.07	1107	53	15.7
CJBC-2525-4M 3/4	1310	9/9	4.50		0.55	3240	70	23.3
CJBC-2525-6M 1/3	830	9/9	2.40		0.25	2430	61	22.3
CJBC-2828-4M 3/4	1310	10/10	4.50		0.55	3555	70	27.3
CJBC-2828-6M 1/3	830	10/10	2.40		0.25	2880	61	26.2
CJBC-3333-6M 1	850	12/12	6.30		0.75	5400	70	38.3
CJBC-3333-6T 1 1/2	900	12/12	6.60	3.80	1.10	7020	74	38.7
CJBC-3939-6T 3	890	15/15	10.90	6.30	2.20	10710	74	58.0
CJBC/ECO-3333-6T 1 1/2	900	12/12	6.6	3.8	1.1	7020	74	40.6
CJBC/ECO-3939-6T 3	890	15/15	10.9	6.3	2.2	10710	74	60.0



Erp. BEP (best efficiency point) characteristics

MC	Measurement category	ηe[%]	Efficiency
EC	Efficiency category	N	Efficiency grade
S	Static	[kW]	Input power
T	Total	[m³/h]	Airflow
VSD	Variable-speed drive	[mmH₂O]	Static or total pressure (According to EC)
SR	Specific ratio	[RPM]	Speed

Model	MC	EC	VSD	SR	ηe[%]	N	(kW)	(m³/h)	(mmH₂O)	(RPM)
CBD-1919-4M 1/5	A	S	NO	1.00	27.7%	38.6	0.194	926	21.3	1331
CBD-1919-6M 1/10	-	-	-	-	-	-	0.122	897	11.8	878
CBD-2525-4M 1/2	A	S	NO	1.00	35.4%	43.5	0.529	2000	34.4	1316
CBD-2525-4M 3/4	A	S	NO	1.00	37.0%	44.6	0.637	2265	38.2	1350
CBD-2828-4M 1/2	A	S	NO	1.00	38.4%	46.1	0.599	2279	37.0	1292
CBD-2828-4M 3/4	A	S	NO	1.00	39.4%	46.2	0.871	3138	40.2	1295
CBD-2828-6M 1/3	A	S	NO	1.00	30.8%	39.7	0.387	2251	19.4	856
CBD-2828-6M 3/4	A	S	NO	1.00	30.1%	38.7	0.443	2549	19.2	930
CBD-3333-6T 1 1/2	A	S	NO	1.00	38.0%	44.1	1.116	5035	31.0	897
CBD-3333-6M 3/4	A	S	NO	1.00	33.8%	40.6	0.857	3787	28.1	865
CBD-3333-6M 1	A	S	NO	1.00	32.0%	38.3	1.040	4377	27.9	871
CBD-3939-6T 3	A	S	NO	1.01	44.3%	48.5	2.188	7721	46.1	924
CBD-1919-4M 1/5 3V	A	S	NO	1.00	27.7%	38.6	0.194	950	20.7	1322
CBD-2525-4M 1/2 3V	A	S	NO	1.00	35.0%	43.1	0.523	1928	34.8	1319
CBD-2525-4M 3/4 3V	A	S	NO	1.00	35.3%	42.8	0.664	2251	38.2	1343
CBD-2525-6M 1/3 3V	A	S	NO	1.00	25.0%	34.7	0.295	1814	14.9	890
CBD-2828-4M 1/2 3V	A	S	NO	1.00	38.3%	46.1	0.587	2120	38.9	1329
CBD-2828-4M 3/4 3V	A	S	NO	1.00	39.2%	46.1	0.832	2916	41.1	1304
CBD-2828-6M 1/3 3V	A	S	NO	1.00	30.6%	39.5	0.388	2263	19.3	851
CBD-2828-6M 3/4 3V	A	S	NO	1.00	30.1%	38.7	0.441	2559	19.1	930
CBD-3333-6M 3/4 3V	A	S	NO	1.00	32.9%	39.6	0.872	3683	28.6	863
CBD-3333-6M 1 3V	A	S	NO	1.00	31.0%	37.2	1.064	4297	28.2	868

Acoustic features

The specified values are determined according to free field measurements of sound levels in dB(A) at an equivalent distance of twice the fan's span plus the impeller's diameter, with a minimum of 1.5 m.

Sound power Lw(A) spectrum in dB(A) via frequency band in Hz. Maximum speed

Model	63	125	250	500	1000	2000	4000	8000	Model	63	125	250	500	1000	2000	4000	8000
CJBC-1919-4M 1/5	43	54	58	62	64	63	62	53	CJBC-3333-6M 1	55	66	70	74	76	75	74	65
CJBC-1919-6M 1/10	38	49	53	57	59	58	57	48	CJBC-3333-6T 1 1/2	59	70	74	78	80	79	78	69
CJBC-2525-4M 3/4	55	66	70	74	76	75	74	65	CJBC-3939-6T 3	61	72	77	81	83	81	80	71
CJBC-2525-6M 1/3	46	57	61	65	67	66	65	56	CJBC/ECO-3333-6T 1 1/2	59	70	74	78	80	79	78	69
CJBC-2828-4M 3/4	55	66	70	74	76	75	74	65	CJBC/ECO-3939-6T 3	61	72	77	81	83	81	80	71
CJBC-2828-6M 1/3	46	57	61	65	67	66	65	56									



Version with circular inlet/outlet

Dimensions in mm

CJBC

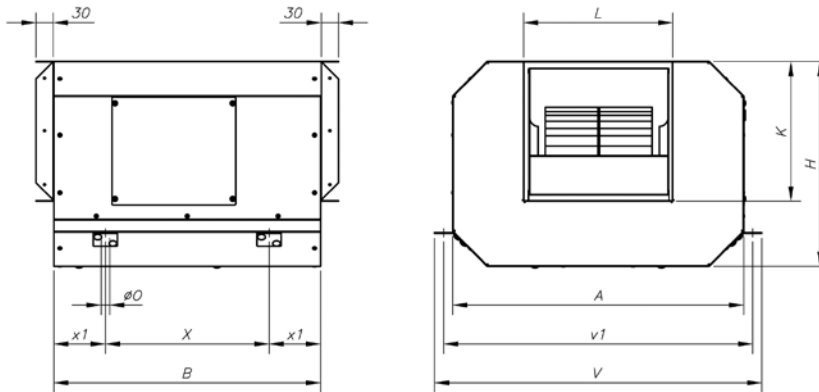

Model	A	B	H	K	L	øO	V	v1	X	x1
CJBC-1919-4M -1/5	480	440	340	210	225	15	540	510	270	85
CJBC-1919-6M -1/10	480	440	340	210	225	15	540	510	270	85
CJBC-2525-4M -3/4	630	575	405	265	291	15	690	660	375	100
CJBC-2525-6M -1/3	630	575	405	265	291	15	690	660	375	100
CJBC-2828-4M -3/4	696	645	460	290	320	15	755	725	445	100
CJBC-2828-6M -1/3	696	645	460	290	320	15	755	725	445	100
CJBC-3333-6M -1	825	760	535	345	379	15	885	855	510	125
CJBC-3333-6T -1 1/2	825	760	535	345	379	15	885	855	510	125
CJBC-3939-6T -3	910	900	636	405	467	15	970	940	650	125

CJBC/ECO

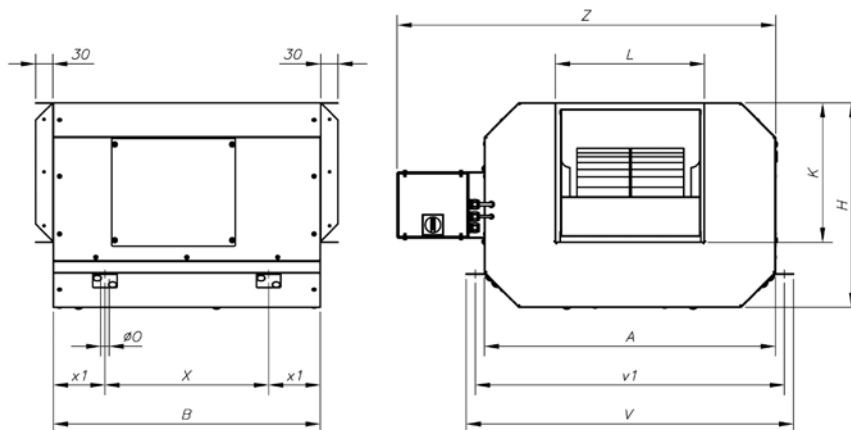

Model	A	B	H	K	L	øO	V	v1	X	x1	Z
CJBC/ECO-3333-6T -1 1/2	825	760	535	345	379	15	885	855	510	125	1080
CJBC/ECO-3939-6T -3	910	900	636	405	467	15	970	940	650	125	1200

Characteristic Curves

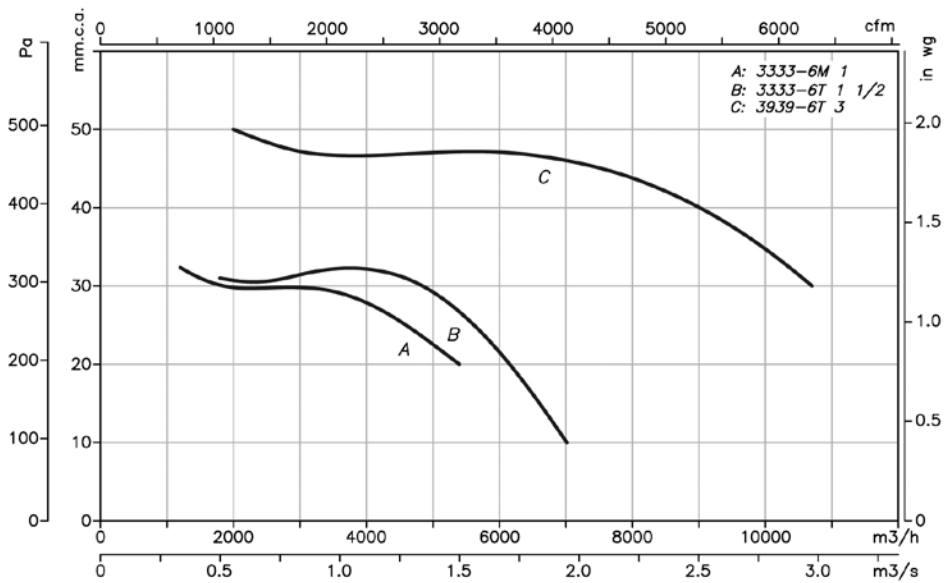
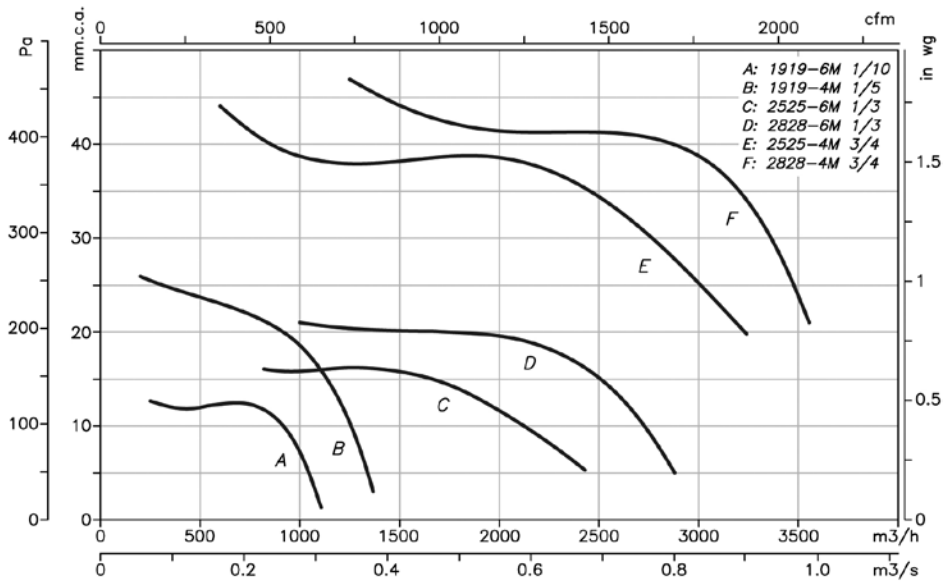

Accessories

See accessories section.

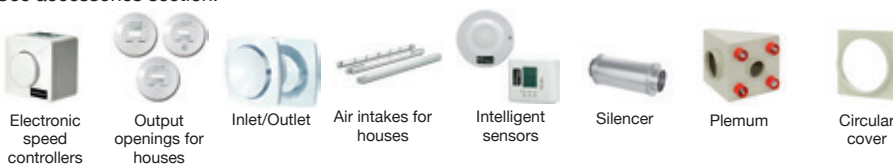

NEOLINEO

In-line fans for small ducts with removable covers with Long Life ball bearings

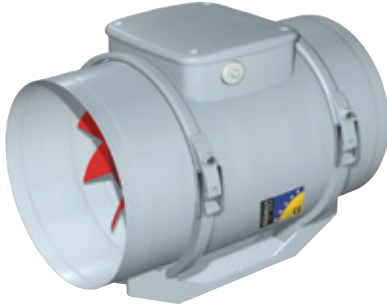

- Fan:
- V0 flame-retardant plastic casing
 - External terminal board, with variable position
 - Quick and easy to install
 - T-models are fitted with timer

- Motor:
- Motors with Long Life ball bearings, IPX4 protection, two-speed and adjustable
 - Single-phase 220-240V. 50/60 Hz
 - Working temperature: -10°C +60°C

- Finish:
- Made from white, V0 flame-retardant plastic

Order code

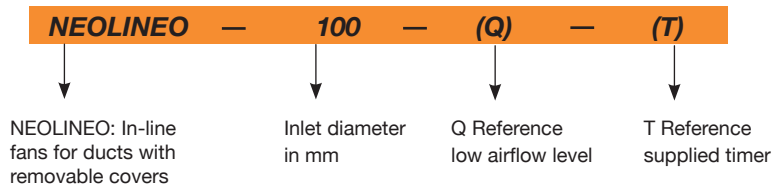

Technical characteristics

Model	Speed max / min. (r/min)	Maximum admissible current 230V (A)	Installed power (W)	Maximum Airflow (m ³ /h)	Irradiated sound level* dB(A)	Approx. weight (Kg)
NEOLINEO-100-Q	2450/2070	0.07/0.05	15/12	200/155	29/25	1.2
NEOLINEO-100-Q T	2450/2070	0.07/0.05	15/12	200/155	29/25	1.2
NEOLINEO-100	2170/1590	0.11/0.09	23/20	255/180	30/25	1.8
NEOLINEO-100 T	2170/1590	0.11/0.09	23/20	255/180	30/25	1.8
NEOLINEO-125	2300/1600	0.15/0.11	33/25	365/250	33/27	1.8
NEOLINEO-125 T	2300/1600	0.15/0.11	33/25	365/250	33/27	1.8
NEOLINEO-150	2290/1520	0.26/0.18	58/40	550/385	33/28	2.4
NEOLINEO-150 T	2290/1520	0.26/0.18	58/40	550/385	33/28	2.4
NEOLINEO-160	2290/1520	0.26/0.18	58/40	550/385	34/28	2.4
NEOLINEO-160 T	2290/1520	0.26/0.18	58/40	550/385	34/28	2.4
NEOLINEO-200-Q	2720/1780	0.37/0.22	75/45	950/700	36/30	3.7
NEOLINEO-200	3120/1990	0.63/0.21	74/22	1060/790	38/32	3.7
NEOLINEO-200 T	3120/1990	0.63/0.21	74/22	1060/790	38/32	3.7
NEOLINEO-250-Q	2520/1740	0.50/0.40	110/85	990/720	39/37	7.1
NEOLINEO-250	3010/1720	1.06/0.26	124/27	1250/650	57/43	5.3
NEOLINEO-315	2350/1800	1.60/0.83	240/119	1900/1400	60/53	9.5

(*) The radiated sound pressure levels are free field measurements at 3 metres with rigid tubes during inlet and outlet.



Erp. BEP (best efficiency point) characteristics

MC	Measurement category	ηe[%]	Efficiency
EC	Efficiency category	N	Efficiency grade
S	Static	[kW]	Input power
T	Total	[m³/h]	Airflow
VSD	Variable-speed drive	[mmH₂O]	Static or total pressure (According to EC)
SR	Specific ratio	[RPM]	Speed

Model	MC	EC	VSD	SR	ηe[%]	N	(kW)	(m ³ /h)	(mmH ₂ O)	(RPM)
NEOLINEO-315	C	S	NO	1,00	33,5%	50,1	0,261	1061	30,27	2350

Dimensions in mm

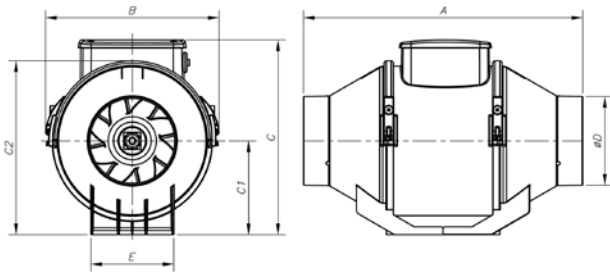

Model	A	B	C	C1	C2	øD	E
NEOLINEO-100-Q	231	156	174	82	152	96	95
NEOLINEO-100-Q T	231	156	174	82	152	96	95
NEOLINEO-100	303	188.5	211	101.5	189	96	90
NEOLINEO-100 T	303	188.5	211	101.5	189	96	90
NEOLINEO-125	258	188.5	211	101.5	189	122	90
NEOLINEO-125 T	258	188.5	211	101.5	189	122	90
NEOLINEO-150	294	214.5	234	112.5	212	146	110
NEOLINEO-150 T	294	214.5	234	112.5	212	146	110
NEOLINEO-160	272.5	214.5	234	112.5	212	156	110
NEOLINEO-160 T	272.5	214.5	234	112.5	212	156	110
NEOLINEO-200-Q	300	234.5	260.5	125.5	235	196	140
NEOLINEO-200	300	234.5	260.5	125.5	235	196	140
NEOLINEO-200 T	300	234.5	260.5	125.5	235	196	140
NEOLINEO-250-Q	385	300	317	152.5	292	247	176.5
NEOLINEO-250	385	300	317	152.5	292	247	176.5
NEOLINEO-315	448	361.5	392.5	188.5	359	312	220.5

Characteristic Curves

Q = Airflow in m³/h

Pe = Static pressure in mm.w.c., Pa

— Maximum speed
 - - - - Minimum speed

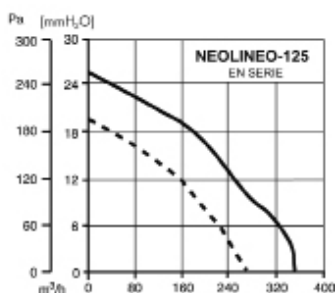
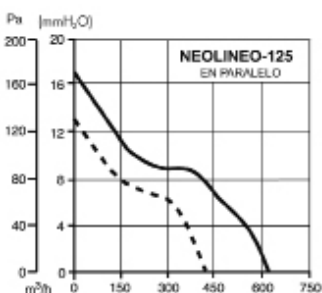
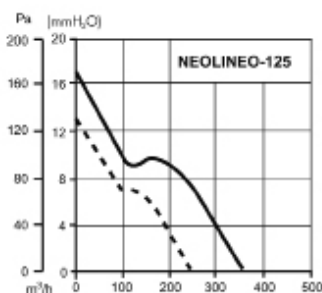
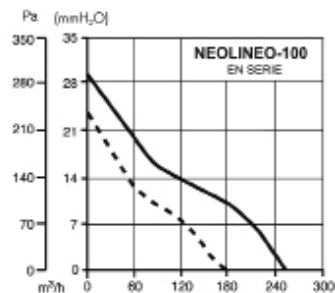
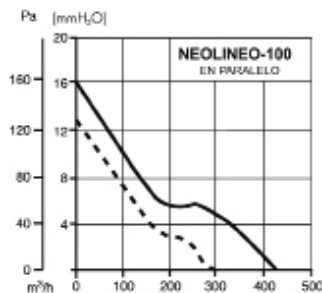
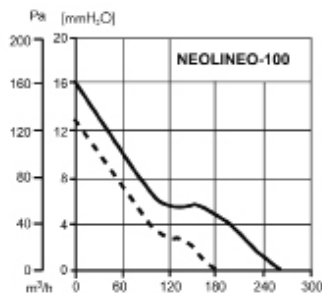
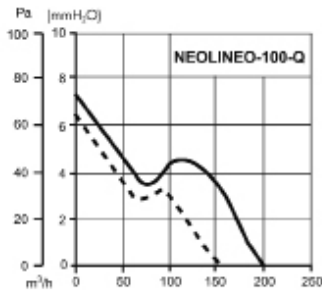

Characteristic Curves

Q = Airflow in m³/h
 Pe = Static pressure in mm.w.c., Pa

— Maximum speed
 - - - Minimum speed

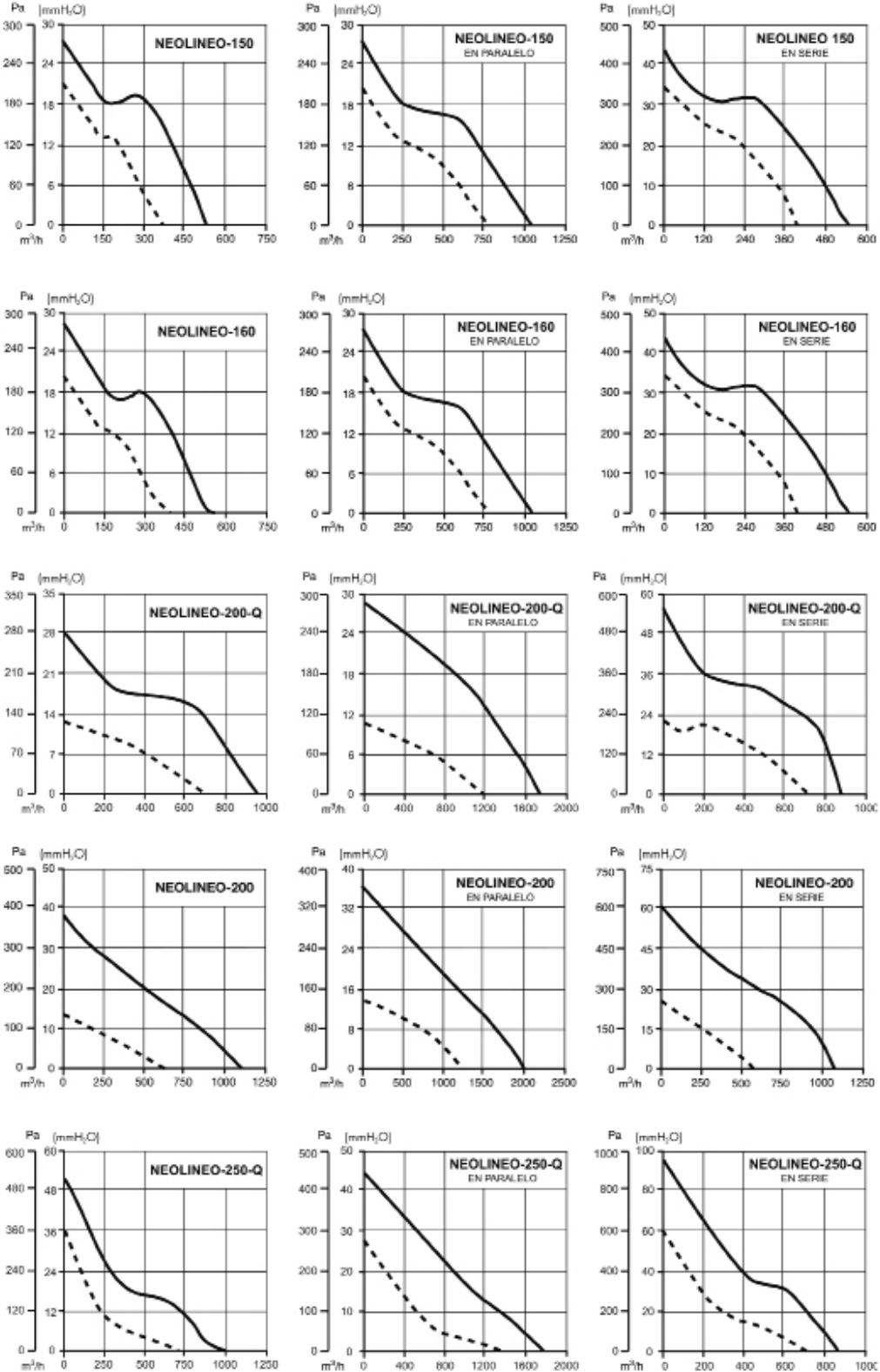

Characteristic Curves

Q = Airflow in m³/h
 Pe = Static pressure in mm.w.c., Pa

— Maximum speed
 - - - Minimum speed

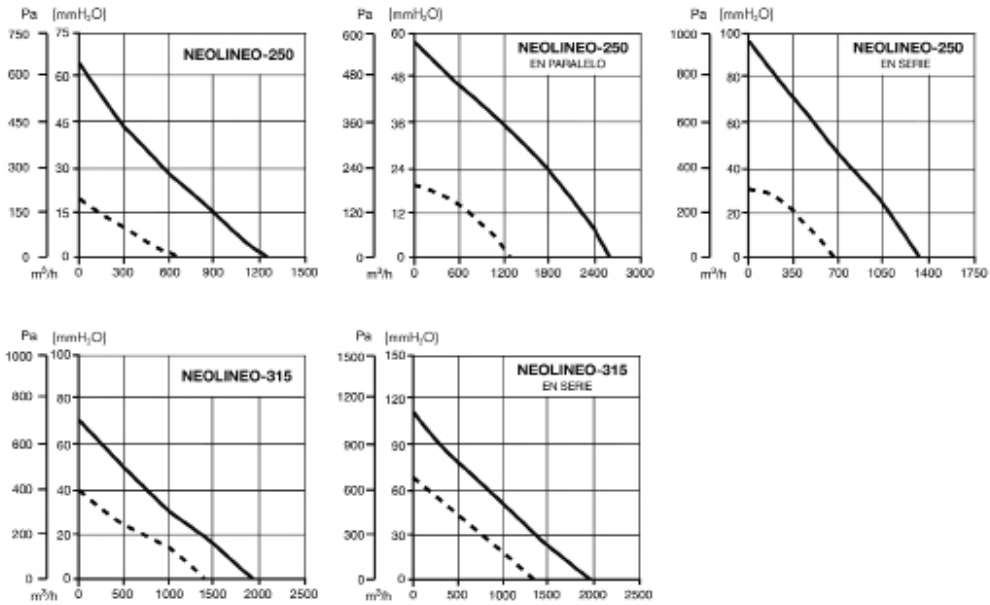

Accessories

See accessories section.



PLATT



Extractor with multiple inlets/outlets and low silhouette

Low profile extractor, for installation in false ceilings and for the extraction of 4 different areas in family houses or apartments

- Designed for continuous operation, in horizontal and vertical positions
- Easy flow control in the extraction grilles themselves
- Perfect impeller and housing design to achieve high performance at low noise and power consumption levels

Construction:

- Support box and plastic outlets
- Upper structure made from galvanized sheets
- Air intake via 3 x 80 mm openings and 1 x 125 mm opening
- Air extraction via 1 x 125 mm opening
- Timer adjustable to 30 minutes

Motor:

- Motors with Long Life ball bearings, IPX4 protection, two-speed
- 230V single-phase. 50 Hz
- Working temperature: -10°C +50°C

HYGRO PLATT-ES



Low silhouette inlets/outlets extractor, designed for extraction via humidity-sensitive openings with electronically controlled brushless-ec motor

Low profile extractor, for installation in false ceilings and for the extraction of 4 different areas in family houses or apartments, where saving energy is an important factor

- Designed for continuous operation, in horizontal and vertical positions
- Exclusively for BE-ALIZE-H type humidity-sensitive grilles
- Perfect impeller and housing design to achieve high performance with low noise and high electrical efficiency (0.1 (w/m3/h))

Construction:

- Support box and plastic outlets
- Upper structure made from galvanized sheets
- Air intake via 3 x 80 mm openings and 1 x 125 mm opening
- Air extraction via 1 x 125 mm opening
- Timer adjustable to 30 minutes

Motor:

- Electronically controlled brushless-ec motor with long lasting ball bearings, IPX4 protection
- 230V single-phase. 50 Hz
- Working temperature: -10°C +50°C

Housing ventilation Kit

See accessories section



Accessories



TB Outlet cap



AB Outlet adapter

Technical characteristics

Model	Speed (r/min)	Max. admissible current (A) 220-240V	Power (W)	Maximum Airflow (m ³ /h)	Irradiated* sound level dB(A)	Weight (Kg)
PLATT	2540	0.24	55	400	49	4
HYGRO PLATT-ES	1450	0.49	55	395	37.5	4

*Irradiated sound pressure level are free field measurements at 3 metres

Dimensions in mm

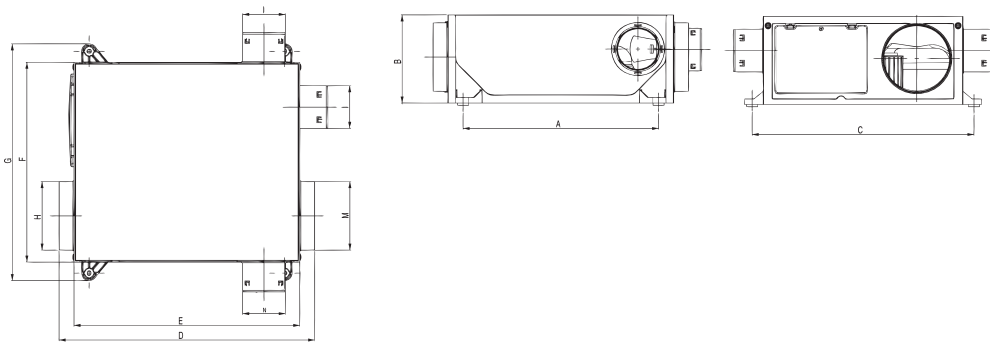

Model	A	B	C	D	E	F	G	H	I	L	M	N
PLATT	355	160	403	464	410	363	430	124.5	77.5	77.5	124.5	77.5
HYGRO PLATT-ES	355	160	403	464	410	363	430	124.5	77.5	77.5	124.5	77.5

Characteristic curves

Q= Airflow in m³/h and m³/s.
Pe= Static pressure in mm.w.c. and Pa

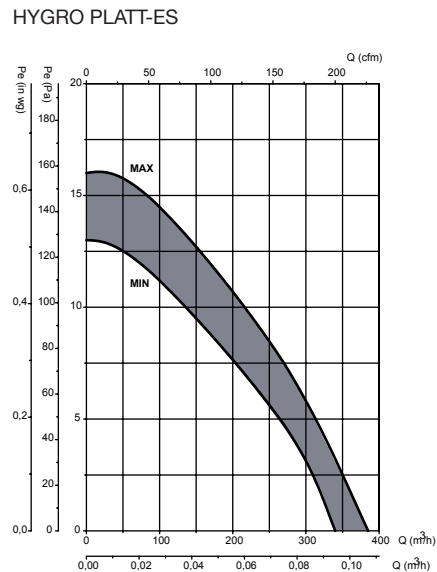
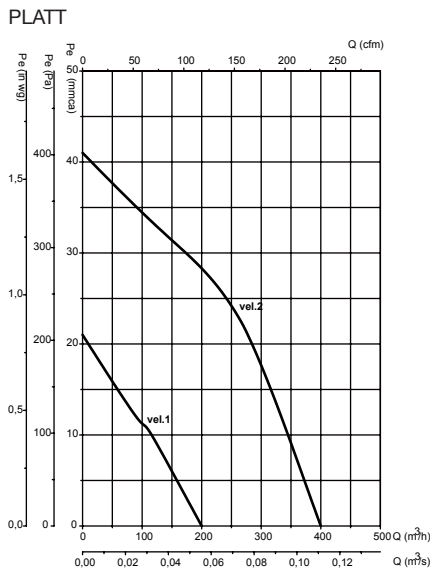

CTD

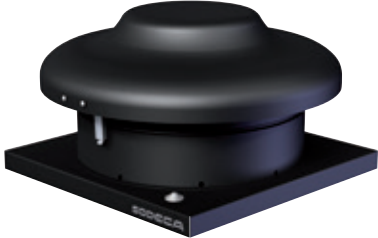

Centrifugal roof fans for ventilation systems for houses

Centrifugal roof fans with low noise level, for ventilation systems for houses according to Technical Building Code

Fan:

- Sheet steel base plate.
- Impeller with backward-curved blades made from sheet steel
- Steel sheet rain deflector hood with anticorrosive protection
- Adjustable by variation of voltage
- Safety switch on request

Motor:

- Class F motors with external rotor, IP54 protection
- Single-phase 230V.-50Hz
- Max. air temperature to transport: -40°C.+ 70°C

Finish:

- Anticorrosive finish in polyester resin, polymerised at 190°C, after alkaline degreasing and phosphate-free pre-treatment



B version

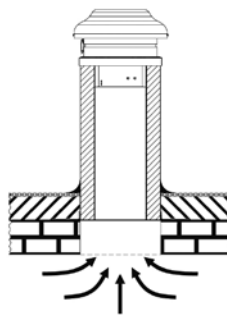

C version

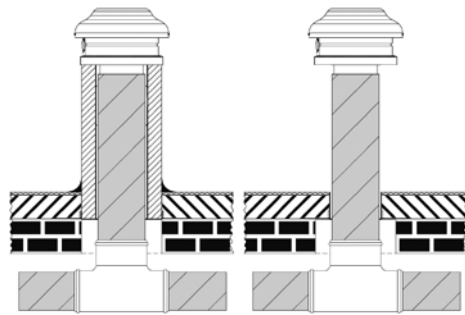

Order code

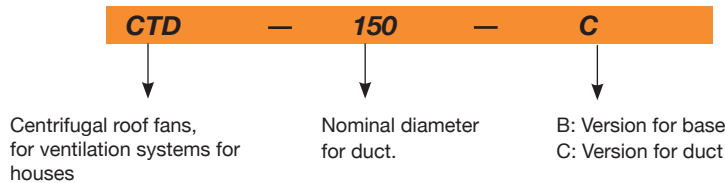

Technical characteristics

Model	Speed (r/min)	Maximum admissible intensity (A) 230V	Installed power (W)	Maximum Airflow (m³/h)	Sound pressure ¹ level at 2/3 of Qmax dB(A)		Approx. weight (Kg)
					Inlet	Outlet	
CTD 150	2442	0.28	65	409	43	37	4.4
CTD 160	2442	0.28	65	409	43	37	4.4
CTD 200	2534	0.42	97	711	46	39	6.8
CTD 250	2542	0.68	155	926	46	41	7.6
CTD 315	2442	0.90	208	1024	48	42	8

(1)The sound level values are measurements of pressure in dB(A) at a distance of 6 m and at 2/3 of the maximum airflow (2/3 Qmax.)

Acoustic features

The specified values are determined according to free field measurements of pressure and sound levels in dB(A) at a distance of 6 m.

Values taken at the inlet with 2/3 of the maximum airflow (2/3Qmax).

Model	Sound power Lw(A) spectrum in dB(A) via frequency band in [Hz].							
	63	125	250	500	1000	2000	4000	8000
CTD 150	38	44	54	59	60	61	57	41
CTD 160	38	44	54	59	60	61	57	41
CTD 200	39	50	57	63	64	62	58	54
CTD 250	40	52	56	63	64	62	56	51
CTD 315	44	57	59	64	65	63	62	57

Values taken at outlet with 2/3 of the maximum airflow (2/3 Qmax).

Model	Sound power Lw(A) spectrum in dB(A) via frequency band in [Hz].							
	63	125	250	500	1000	2000	4000	8000
CTD 150	28	37	51	54	58	53	47	32
CTD 160	28	37	51	54	58	53	47	32
CTD 200	31	44	53	57	58	54	50	40
CTD 250	32	44	53	58	61	59	52	43
CTD 315	34	50	55	58	61	59	52	45

Dimensions in mm

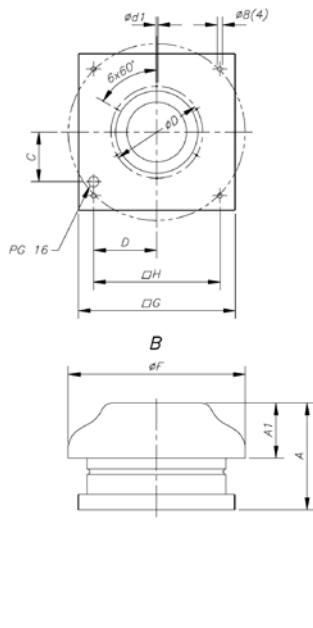

Model	øF	A	A1	∅G	øD	ød1	C	D	∅H	øO
CTD-150/B	344	207.3	107	305	177	6.1	96.5	123.5	245	-
CTD-160/B	344	207.3	107	305	177	6.1	96.5	123.5	245	-
CTD-200/B	450	214.35	109	405	230	7.1	138	168	330	-
CTD-250/B	450	245.55	109	405	230	7.1	138	168	330	-
CTD-315/B	450	245.55	109	405	230	7.1	138	168	330	-
CTD-150/C	344	207.3	107	305	177	6.1	96.5	123.5	245	147
CTD-160/C	344	207.3	107	305	177	6.1	96.5	123.5	245	157
CTD-200/C	450	214.35	109	405	230	7.1	138	168	330	197
CTD-250/C	450	245.55	109	405	230	7.1	138	168	330	247
CTD-315/C	450	245.55	109	405	230	7.1	138	168	330	312

Characteristic curves

Q = Airflow in m³/h, m³/s and cfm.

Pe = Static pressure in mm.w.c., Pa and inwg.

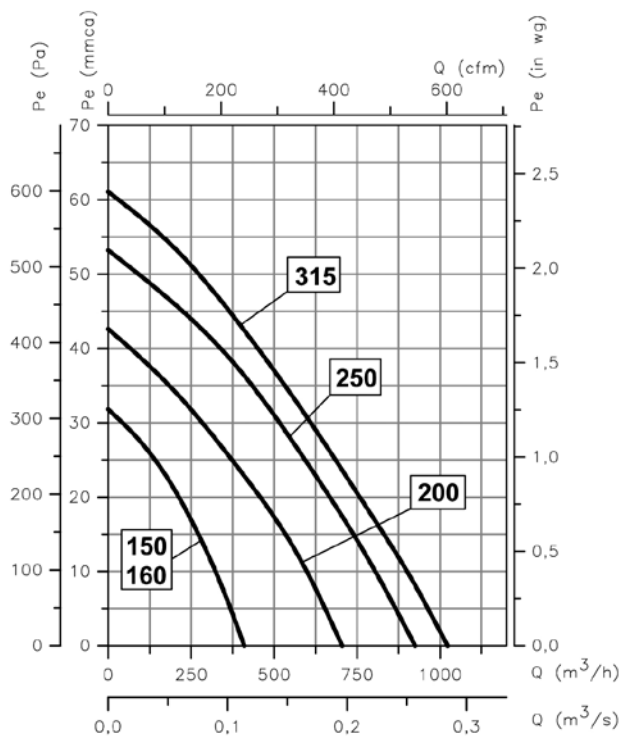

On request

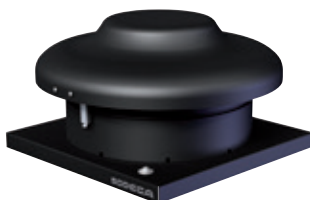

INT Safety switch

CA-ROOF

Centrifugal roof fans for chimney ventilation in houses

In-line centrifugal extractor, with built-in hood to carry out the extraction or impulsion of the air in individual dwellings or community housing

- Designed for continuous operation, in any position
- Possibility of supply with base or directly to pipe, according to the model



Construction:

- Galvanised sheet base plate.
- Impeller with backward-curved blades
- Galvanised sheet rain deflector hood
- Treated with anticorrosive paint

Motor:

- Motor with Long Life ball bearings, IPX4 protection
- 230V single-phase. 50 Hz
- Working temperature: -20°C +50°C
- Automatic thermal protector reset

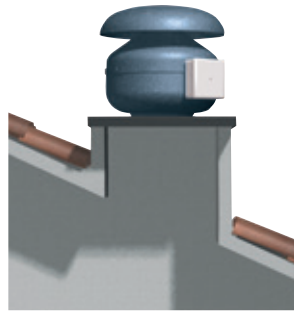

B version



C version

Technical characteristics

Model	Speed (r/min)	Max. admissible current (A) 220-240V	Power (W)	Maximum Airflow (m ³ /h)	Irradiated* sound level dB(A)	Weight (Kg)
CA/ROOF 125	2300	0.34	75	350	54	5
CA/ROOF 150	2370	0.34	80	450	56.5	7
CA/ROOF 160	2650	0.68	150	750	64	8.8
CA/ROOF 200	2700	0.69	160	850	63	8
CA/ROOF 250	2430	0.80	180	1180	61.5	9.9
CA/ROOF 315	2480	1.10	250	1600	64.5	11

*Irradiated sound pressure level are free field measurements at 3 metres

CA/ ROOF-125/C

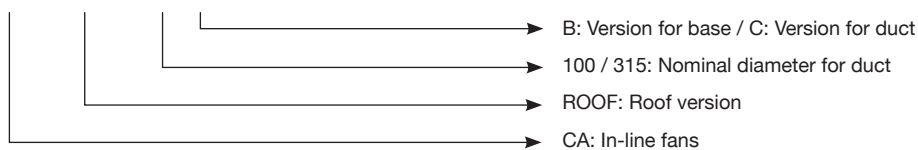

Dimensions in mm

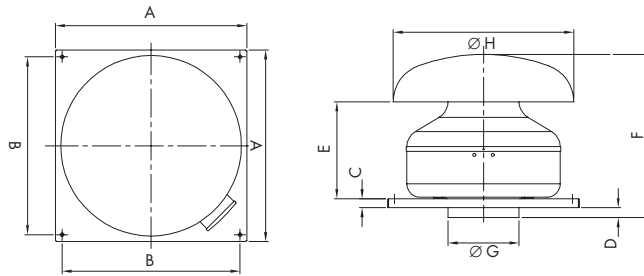

Model	A	B	C	D	E	F	Ø G	Ø H
CA/ROOF 125	334	280	20	2	193	290	122	300
CA/ROOF 150	424	370	20	17	198	340	147	400
CA/ROOF 160	424	370	20	22	214	361	157	400
CA/ROOF 200	424	370	20	17	203	345	197	534
CA/ROOF 250	489	435	20	27	193	376	247	534
CA/ROOF 315	489	435	20	21	226	403	312	534

Characteristic curves

Q= Airflow in m³/h and m³/s.

Pe= Static pressure in mm.w.c. and Pa

CA-ROOF 125

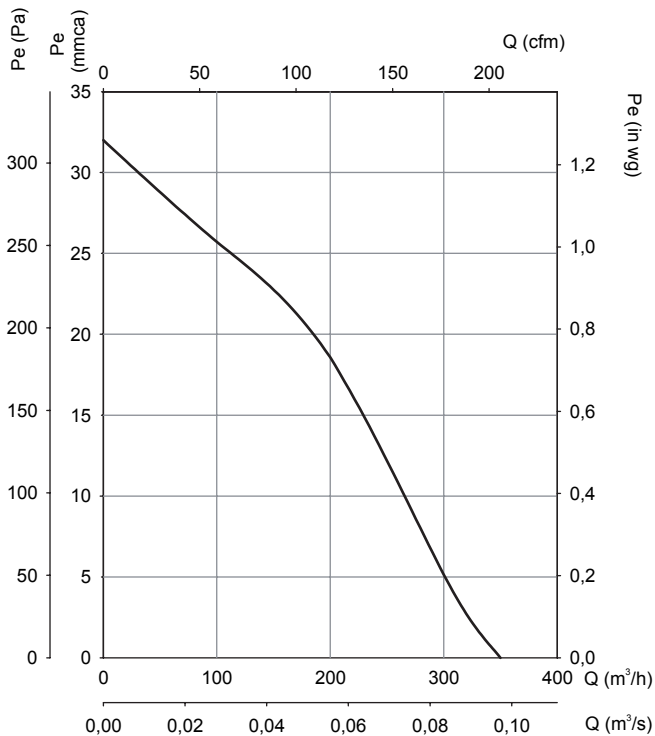

CA-ROOF 150

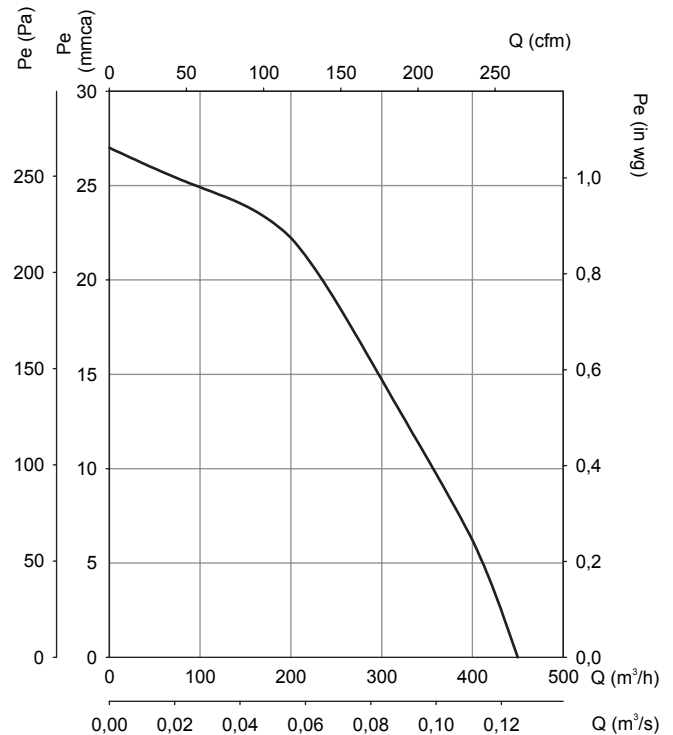

Characteristic curves

Q= Airflow in m³/h and m³/s.
 Pe= Static pressure in mm.w.c. and Pa

CA-ROOF 160

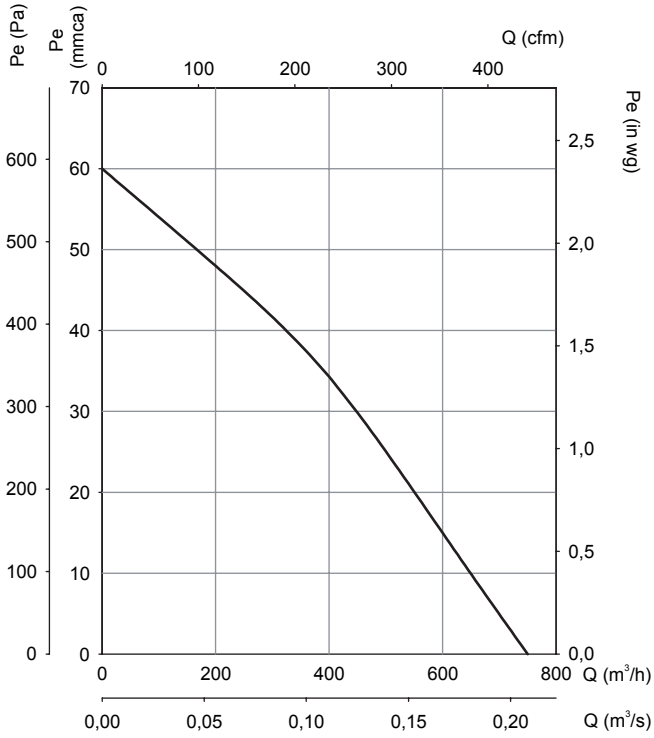

CA-ROOF 200

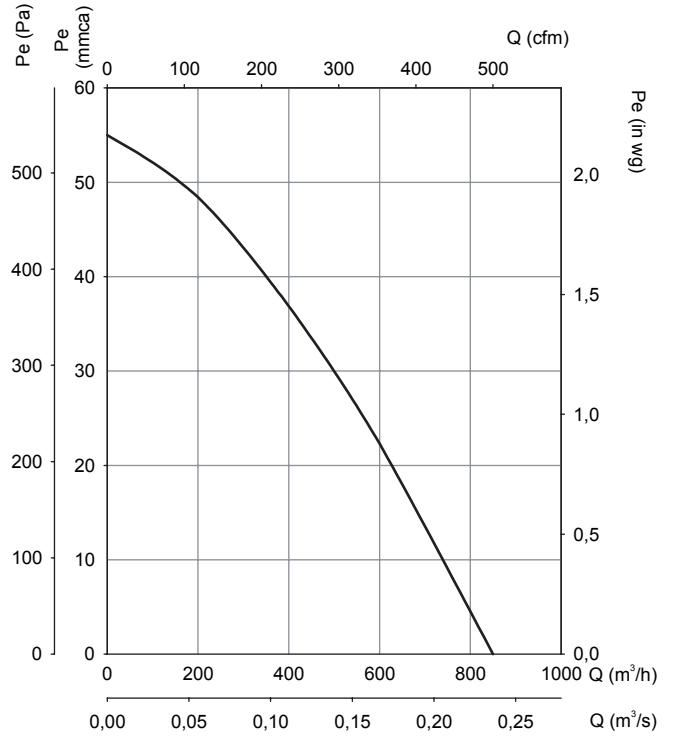

CA-ROOF 250

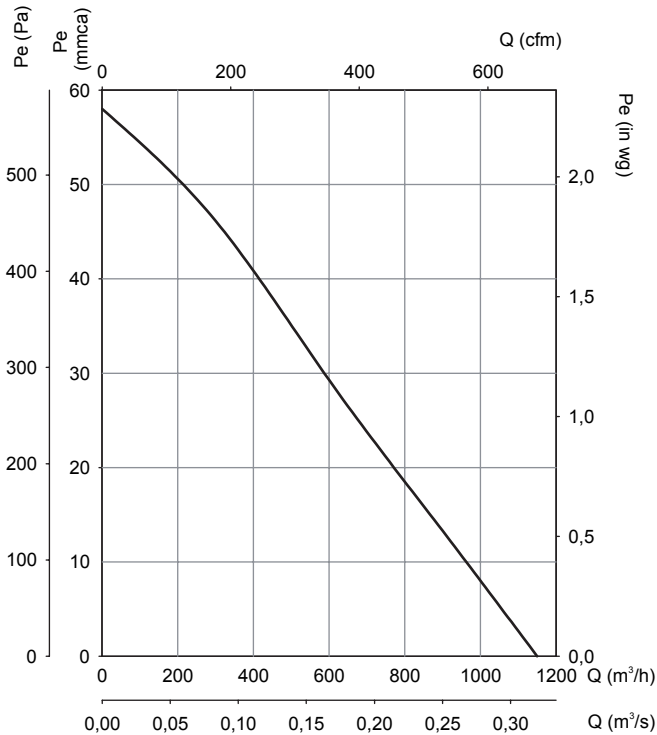

CA-ROOF 315

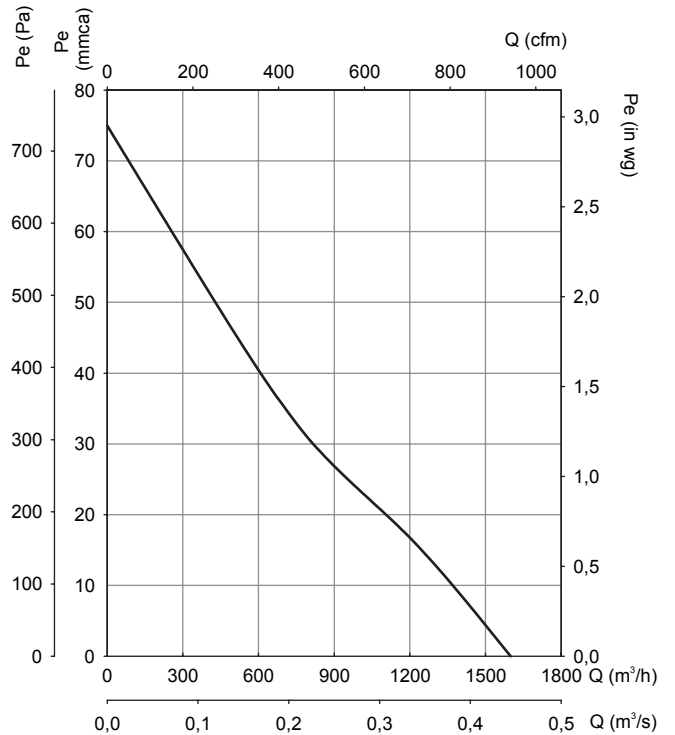

CHRE

Centrifugal roof fans with low noise level

Centrifugal roof fans with low noise level and external rotor motor.



Fan:

- Sheet steel base plate.
- Impeller with backward-curved blades made from sheet steel
- Bird guard
- Sheet steel rain deflector hood with anticorrosive protection

Motor:

- Class F external rotor motors, IP54 protection
- Single-phase 230V.-50Hz., and three-phase 230/400V.-50Hz.
- Max. air temperature to transport: -25°C.+ 50°C

Finish:

- Anticorrosive finish in polyester resin, polymerised at 190°C, after alkaline degreasing and phosphate-free pre-treatment.

Order code

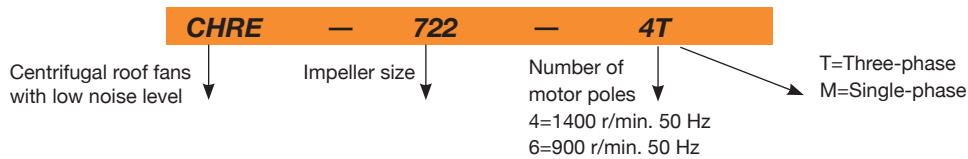

Technical characteristics

Model	Speed (r/min)	Maximum admissible current (A)		Installed power (kW)	Maximum airflow (m³/h)	Sound pressure level at 2/3 of Qmax dB(A)		Approx. weight (Kg)
		230V	400V			Inlet	Outlet	
CHRE-722-4T	1360	0.31	0.18	0.02	650	31	37	7.6
CHRE-722-4M	1360	0.25		0.02	650	31	37	7.6
CHRE-825-4T	1360	0.52	0.30	0.03	950	32	38	9.1
CHRE-825-4M	1360	0.34		0.03	950	32	38	9.1
CHRE-1131-4T	1330	0.78	0.45	0.08	2000	39	45	14.1
CHRE-1131-4M	1330	0.70		0.08	2000	39	45	14.1
CHRE-1131-6T	910	0.43	0.25	0.03	1280	28	34	13.6
CHRE-1131-6M	910	0.35		0.03	1280	28	34	13.6
CHRE-1135-4T	1280	0.95	0.55	0.10	2500	43	48	19.1
CHRE-1135-4M	1280	0.85		0.10	2500	43	48	19.1
CHRE-1135-6T	880	0.52	0.30	0.04	1800	31	38	18.1
CHRE-1135-6M	880	0.50		0.04	1800	31	38	18.1
CHRE-1240-4T	1330	1.49	0.86	0.30	4000	46	52	24.8
CHRE-1240-4M	1330	2.10		0.30	4000	46	52	26.3
CHRE-1240-6T	860	0.61	0.35	0.06	2400	35	41	22.3
CHRE-1240-6M	860	0.70		0.06	2400	35	41	22.8
CHRE-1445-4T	1345	2.17	1.25	0.45	5400	53	59	36.0
CHRE-1445-4M	1345	2.80		0.45	5400	53	59	38.0
CHRE-1445-6T	920	1.13	0.65	0.15	3700	42	48	34.5
CHRE-1445-6M	920	1.10		0.15	3700	42	48	36.0
CHRE-1650-4T	1380	3.29	1.90	0.80	7600	57	62	40.5
CHRE-1650-4M	1380	5.80		0.80	7600	57	62	48.5
CHRE-1650-6T	900	1.40	0.81	0.27	5200	45	52	38.0
CHRE-1650-6M	900	3.00		0.27	5200	45	52	40.0

(1) The sound level values are measurements of pressure in dB(A) at a distance of 6 m and at 2/3 of the maximum airflow (2/3 Qmax.)



Erp. BEP (best efficiency point) characteristics

Model	MC	EC	VSD	SR	ηe[%]	N	(kW)	(m³/h)	(mmH₂O)	(RPM)	ErP characteristics	
											Measurement category	Variable-speed drive
											[mmH₂O]	Static or total pressure
											(According to EC)	Speed
CHRE-722-4T	-	-	-	-	-	-	0.053	345	11.55	1368		
CHRE-722-4M	-	-	-	-	-	-	0.057	348	11.32	1361		
CHRE-825-4T	-	-	-	-	-	-	0.073	561	14.78	1367		
CHRE-825-4M	-	-	-	-	-	-	0.078	567	14.49	1360		
CHRE-1131-4T	C	S	NO	1.00	39.6%	58.5	0.160	1072	21.71	1352		
CHRE-1131-4M	C	S	NO	1.00	41.7%	60.8	0.151	1083	21.33	1341		
CHRE-1131-6T	-	-	-	-	-	-	0.074	712	9.40	920		
CHRE-1131-6M	-	-	-	-	-	-	0.080	719	9.21	911		
CHRE-1135-4T	C	S	NO	1.00	43.0%	60.9	0.196	1182	26.12	1286		
CHRE-1135-4M	C	S	NO	1.00	42.4%	60.2	0.200	1191	26.04	1280		
CHRE-1135-6T	-	-	-	-	-	-	0.108	909	13.19	885		
CHRE-1135-6M	-	-	-	-	-	-	0.116	918	12.93	880		
CHRE-1240-4T	C	S	NO	1.00	46.4%	60.4	0.461	1955	40.11	1347		
CHRE-1240-4M	C	S	NO	1.00	45.3%	59.2	0.467	2081	37.27	1332		
CHRE-1240-6T	-	-	-	-	-	-	0.112	1064	14.66	896		
CHRE-1240-6M	-	-	-	-	-	-	0.120	1127	13.64	889		
CHRE-1445-4T	C	S	NO	1.00	50.7%	63.0	0.668	3441	36.10	1355		
CHRE-1445-4M	C	S	NO	1.00	50.5%	63.1	0.626	3364	34.49	1360		
CHRE-1445-6T	C	S	NO	1.00	42.8%	59.9	0.237	2303	16.16	932		
CHRE-1650-4T	C	S	NO	1.00	51.2%	60.7	1.246	4905	47.71	1380		
CHRE-1650-4M	C	S	NO	1.00	50.9%	60.2	1.307	4976	49.10	1387		
CHRE-1650-6T	C	S	NO	1.00	44.9%	59.4	0.414	3252	20.97	937		
CHRE-1650-6M	C	S	NO	1.00	44.0%	58.5	0.416	3234	20.75	934		

Best efficiency point data of the motor-impeller unit

Acoustic features

Values taken at inlet with 2/3 of the maximum airflow (2/3Qmax).

Values taken at outlet with 2/3 of the maximum airflow (2/3Qmax).

Sound power Lw(A) spectrum in dB(A) via frequency band in Hz.

Model	63	125	250	500	1000	2000	4000	8000
722	29	35	46	49	50	46	44	38
825	30	36	47	50	51	47	45	39
1131-4	40	49	54	54	58	57	50	44
1131-6	29	38	43	43	47	46	39	33
1135-4	44	53	58	58	62	61	54	48
1135-6	32	41	46	46	50	49	42	36
1240-4	48	54	60	60	63	66	57	51
1240-6	37	43	49	49	52	55	46	40
1445-4	55	61	67	67	70	73	64	58
1445-6	44	50	56	56	59	62	53	47
1650-4	60	67	72	72	76	75	68	63
1650-6	48	55	60	60	64	63	56	51

Model	63	125	250	500	1000	2000	4000	8000
722	33	38	52	54	55	55	50	45
825	34	39	53	55	56	56	51	46
1131-4	39	48	58	62	65	62	55	49
1131-6	28	37	47	51	54	51	44	38
1135-4	42	51	61	65	68	65	58	52
1135-6	32	41	51	55	58	55	48	42
1240-4	47	59	67	69	70	70	62	54
1240-6	36	48	56	58	59	59	51	43
1445-4	54	66	74	76	77	77	69	61
1445-6	43	55	63	65	66	66	58	50
1650-4	58	70	78	80	81	78	71	63
1650-6	48	60	68	70	71	68	61	53

To obtain the Lwa sound power spectra in dB(A) at the inlet with the maximum airflow (Qmax), add the values in the following tables to the LpA sound pressure level given on the characteristic curves:

Frequency band in Hz							
63	125	250	500	1000	2000	4000	8000
2	9	15	15	18	18	11	5

Dimensions in mm

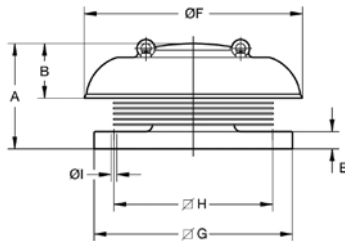

Model	A	B	E	ØF	ØG	ØH	ØI
CHRE-722	194	110	30	440	355	295	12
CHRE-825	212	110	35	440	400	320	12
CHRE-1131	308	176	40	620	450	360	12
CHRE-1135	325	176	40	620	560	450	12
CHRE-1240	351	176	40	620	560	450	12
CHRE-1445	393	228	40	770	710	590	12
CHRE-1650	426	228	40	770	710	590	12

Variation of sound pressure depending on distance

The sound level may vary depending on the roof structure.

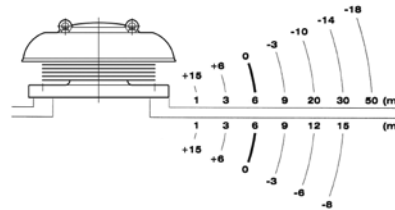

Characteristic curves

Q = Airflow in m³/h, m³/s and cfm.
inwa.

Pe= Static pressure in mmH₂O, Pa and

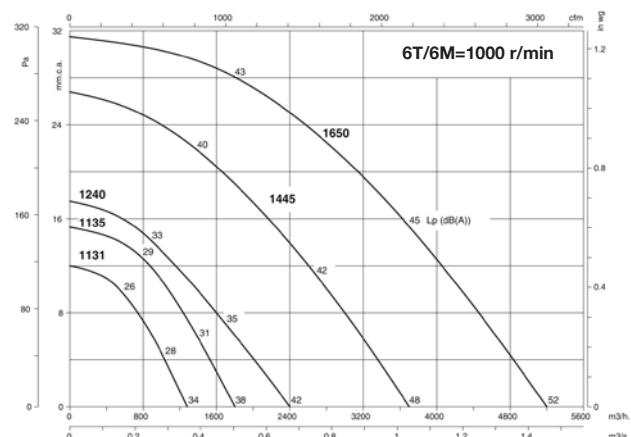
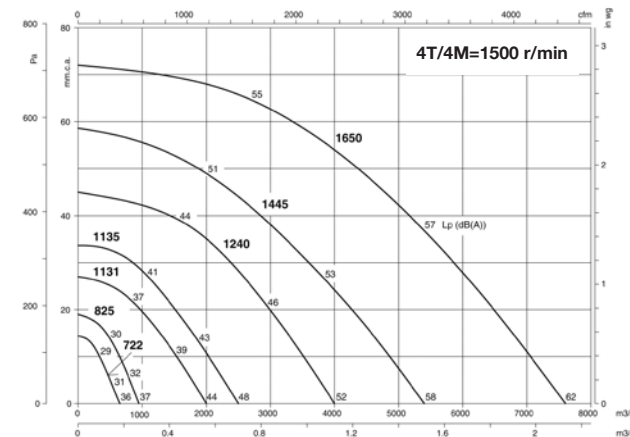

Accessories

See accessories section



RCH



SI-VENT Accessories



Fan and chimney top for hybrid extraction in community housing

- Designed especially for the air extraction in houses or community housing, through chimneys or shunts. It makes it possible to maintain an attractive and uniform design throughout the building
- The Venturi version without fan, only for natural extraction
- The lightness of aluminium allows a fast and simple installation on roof

Construction:

- Manufactured in black pre-lacquered aluminium which is not altered by atmospheric agents
- Perfectly designed slats so as to obtain a high-performance Venturi effect
- Supplied voltage 230V. 50 Hz

- VENTURI: Natural operation without an extractor using the Venturi effect
- TEMPERATURA: Designed for the extraction of air in homes and barbecues with a maximum temperature of 150°C

On request:

- Measurements to fit any chimney

Versions:

- BASIC: It works with a switch or with a SI-VENT wind monitor



SYSTEM OF HYBRID VENTILATION (H.V)

This system is based on the extraction of air in a natural manner when the wind conditions outside are favourable whereas when they are unfavourable the extractor with an electric motor comes into operation to guarantee the minimum necessary extraction.

The start up of the electrical extractor is carried out by means of wind sensors, which are especially designed for this application



WIND CONTROLLER

SI-VENT, Wind sensor

The SI-VENT electronic wind controller is a highly robust and reliable device, made up of a sensor, a controller and the power supply.

The sensor is capable of measuring winds of up to 100 k.p.h. and the controller starts up the electrical extractor when the wind speed is below the programmed minimum wind value for five minutes.

RCH-400x800VM



Fan and chimney top for hybrid extraction in community housing

An assembly specially designed for controlled mechanical extraction through chimneys or condominium shunt chimneys. The system makes it possible to maintain a constant pressure in the installation, with the speed of the extractor self-regulated, obtaining the flow necessary at each moment according to the different needs of the installation, achieving a significant energy saving

- It makes it possible to maintain an attractive and uniform design throughout the house
- The lightness of aluminium allows a fast and simple installation on roof
- Measurements can be adapted to any chimney upon request

Construction:

- Manufactured in black pre-lacquered aluminium which is not altered by atmospheric agents
- Perfectly designed slats so as to obtain a high-performance Venturi effect
- Impeller unit with backward-curved blades with external rotor motor
- Adjustable differential pressure transmitter from 0...250 Pa, including screen for digital display and connection accessories

- Speed regulator by means of a frequency converter VSD1/A-RFM-0.5

Motor:

- Motor with Long Life ball bearings, IPX4 protection
- Converter supply, single-phase 230V. 50 Hz, output voltage from the converter to the motor, three-phase 230v. 50Hz
- Working temperature: -20°C +50°C

Technical characteristics

Model	Speed (r/min)	Max. admissible current (A) 220-240V	Installed power (kW)	Maximum Airflow (m³/h)	Sound pressure level (1) at 2/3 of Qmax db (A)		Weight aprox (Kg)
					Inlet	Outlet	
RCH-400x400B	1360	0.34	0.03	950	32	35	9
RCH-400x400T	1380	0.65	0.25	1450	37	40	25
RCH-400x600B	910	0.35	0.03	1280	28	31	14
RCH-400x800B	880	0.50	0.04	1800	31	35	18
RCH-400x800VM	1280	0.95	0.10	2500	43	48	19

(1) The sound level values are measurements of pressure in dB(A) at a distance of 6 m and at 2/3 of the maximum airflow (2/2 Qmax).

Dimensions in mm

Model	A	B	C	Useful area
RCH-400x400B	400	400	420	
RCH-400x400T	400	400	600	
RCH-400x600B	400	600	420	
RCH-400x800B	400	800	420	
RCH-400x800VM	400	800	420	
RCH-400x400V	400	400	600	0.134 m²
RCH-400x600V	400	600	600	0.191 m²
RCH-400x800V	400	800	600	0.248 m²

Characteristic curves

Q= Airflow in m³/h and m³/s.
 Pe= Static pressure in mm.w.c. and Pa

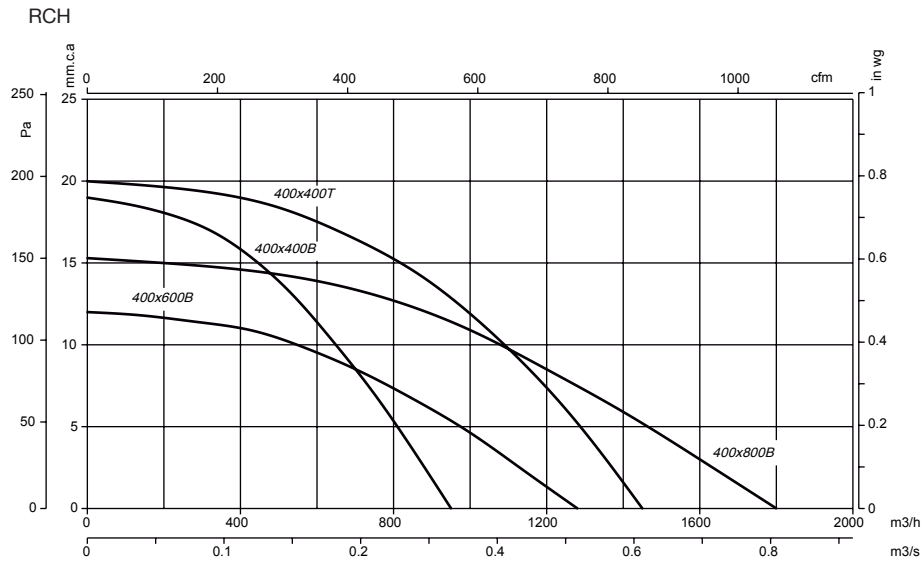

RCH-400x800VM

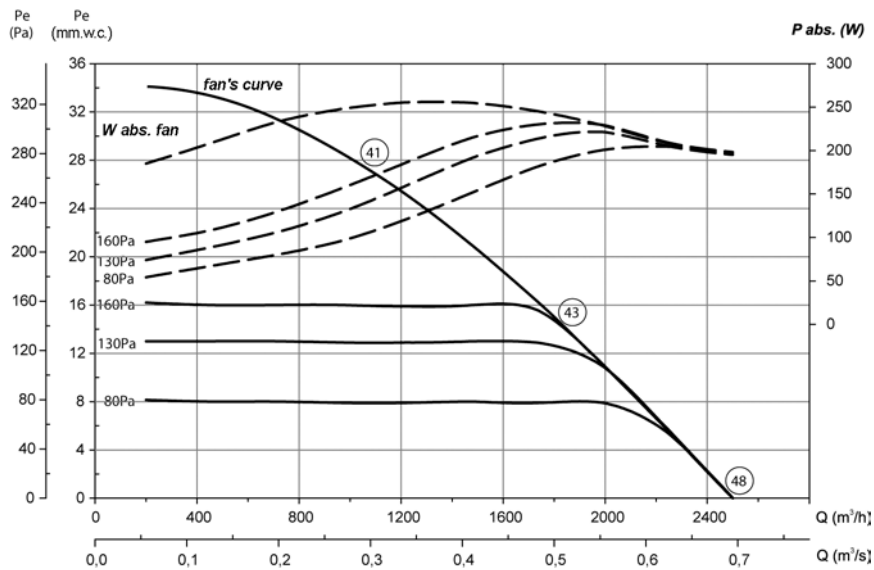

○ The LpA sound levels given on the curves are free field pressure measurements at 6 metres at the inlet.

Working examples

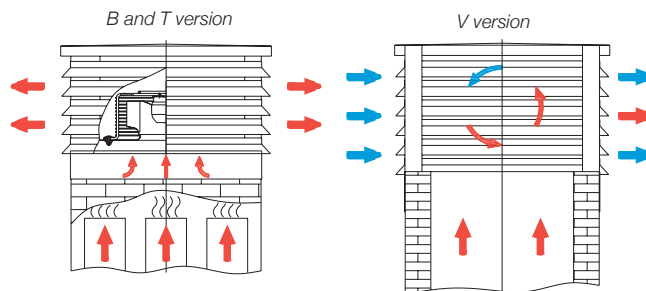

TIRACAMINO

Fans to extract smoke in chimneys and barbecues



- Especially designed to extract smoke in chimneys and barbecues up to 200°C
- Equipped with an electronic speed regulator to adjust the smoke extraction flow rate
- Designed for continuous operation 200°C

Construction:

- Made from sheet steel with polyester resin to resist atmospheric agents
- Bird guard
- Supplied voltage 230V. 50 Hz

Motor:

- BASIC: works with separate switch or regulator

Technical characteristics

Model	Speed (r/min)	Maximum admissible current (A) 230V	Absorbed power (W)	Maximum Airflow (m³/h)	Sound pressure level(*) dB(A)	Approx. weight (Kg)
TIRACAMINO	1400	0.50	120	750	52	14.3

(*) The sound level values are measurements of pressure in dB(A) at a distance of 3 m with maximum airflow

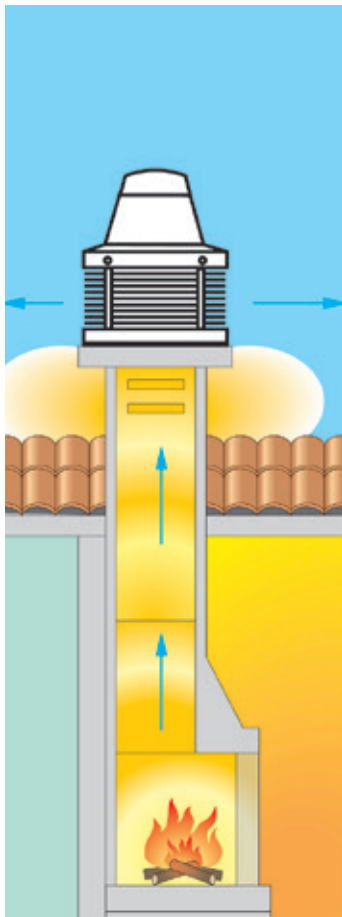

Dimensions in mm

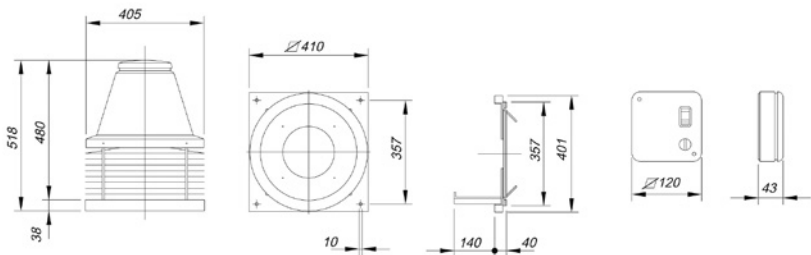

Characteristic curves

Q= Airflow in m³/h and m³/s. Pe= Static pressure in mm.w.c. and Pa

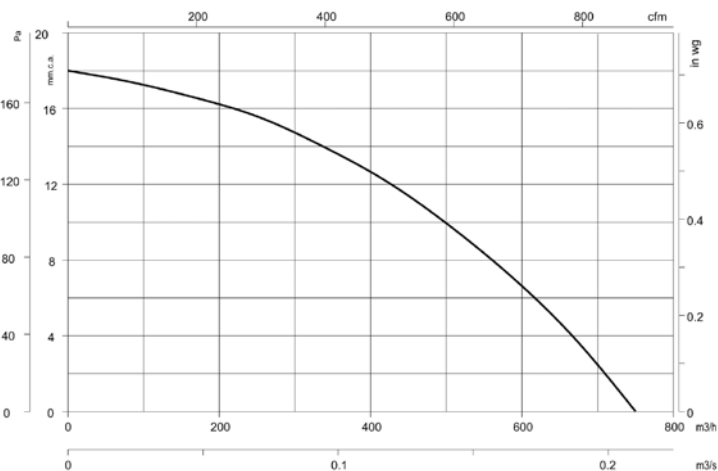

EDMF

Extra-flat bathroom fans with aesthetic and modern design



- Integrates harmoniously into the bathroom
- Ultra-silent
- Slim design with only 17mm
- High efficiency aerodynamic design
- Quick and easy to install

- Construction:
- White finish
 - Non-return hatch incorporated in all models
 - Built with recyclable materials

- Version:
- BASIC: works with the light switch or standalone
 - TIMER: works with adjustable electronic timer
 - LL: Long Life ball bearings

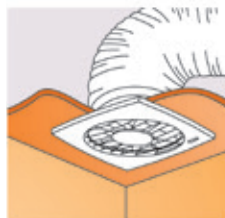
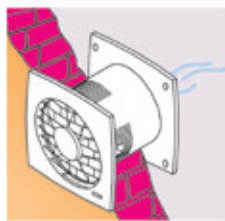

Technical characteristics

Model	Version	Speed (r/min)	Power (W)	Airflow (m³/h)	Sound pressure level at 3m (dBA)	Weight (Kg)
EDMF-100	Basic	2300	14	95	34	0.58
EDMF-100-T	Timer	2300	14	95	34	0.58
EDMF-100-LL	LL	2300	14	95	34	0.58
EDMF-100-LL-T	LL/Timer	2300	14	95	34	0.58
EDMF-120	Basic	2400	16	180	35	0.74
EDMF-120-T	Timer	2400	16	180	35	0.74
EDMF-120-LL	LL	2400	16	180	35	0.74
EDMF-150	Basic	2400	24	292	38	0.92
EDMF-150-T	Timer	2400	24	292	38	0.92
EDMF-150-LL	LL	2400	24	292	38	0.92

Dimensions in mm

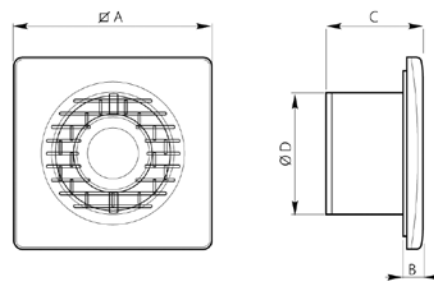

Model	∅A	B	C	∅D
EDMF-100	150	12,5	108,5	100
EDMF-120	176	12,5	114	125
EDMF-150	205	13	132	150

Accessories

See accessories section.



Decorative grille



Backdraught louvre



Electronic speed controllers

Characteristic curves

Q= Airflow in m³/h and m³/s.

Pe= Static pressure in mm.w.c. and Pa

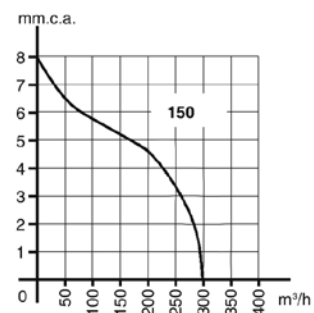
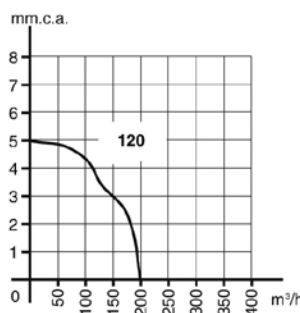
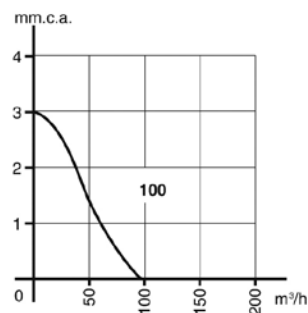



EDQUIET/S

Very low sound level and low consumption domestic extractors



- Integrates harmoniously into the bathroom
- High performance thanks to its low consumption motor
- Quick and easy to install

Construction:

- White finish
- Non-return hatch incorporated
- Equipped with diffusers to reduce air turbulence and noise levels

Versions:

- BASIC: works with the light switch or standalone
- TIMER: works with adjustable electronic timer

Motor:

- Single-phase 220V-240V .50/60 Hz
- High-efficiency motor
- Ball bearings to work over 40.000 hours
- Motor equipped with Klixon

Order code

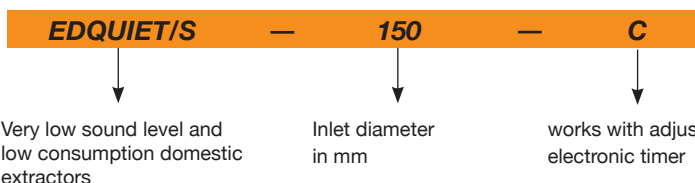

Technical characteristics

Model	Version	Speed (r/min)	Power (W)	Airflow (m ³ /h)	Sound level dB(A)	Weight (Kg)
EDQUIET/S-100	Basic	2000	8	90	29	0,45
EDQUIET/S-100-T	Timer	2000	8	90	29	0,45
EDQUIET/S-150	Basic	2000	28	255	35	0,97
EDQUIET/S-150-T	Timer	2000	28	255	35	0,97

Dimensions in mm

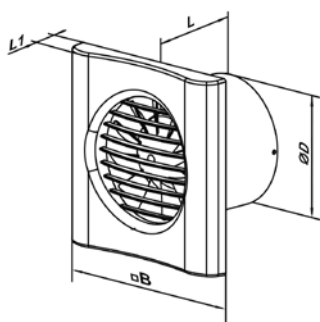

Model	∅D	∅B	L	L1
EDQUIET/S-100	99	150	79	19
EDQUIET/S-150	148	205	112	23

Accessories

See accessories section.



Decorative grille



Backdraught louvre



Electronic speed controllers

Characteristic curves

Q= Airflow in m³/h.
Pe= Static pressure in Pa

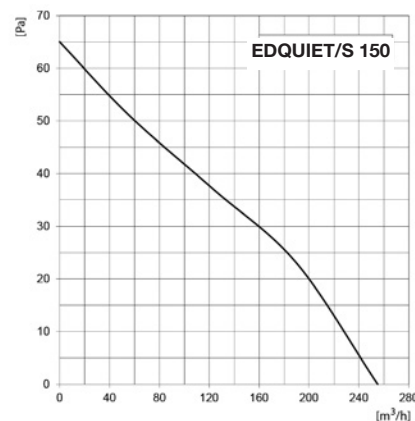
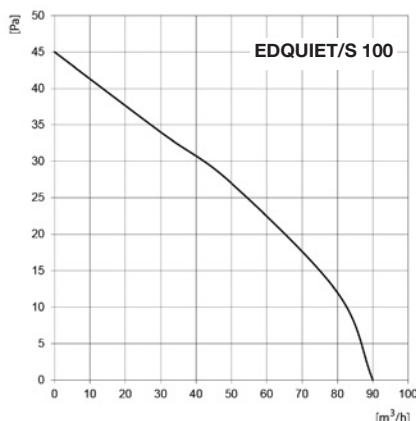

ECONOMIC

Economic air curtains for small commercial premises



Economic air curtains for heights of up to 3m, for horizontal installation, specifically designed for small commercial premises



Construction:

- Painted metal structure
- Designed to be installed in a horizontal position
- S version: Two-speed fan operation
- LED operation indicator
- Support for assembly wall
- E Version: Electric battery control with safety elements. Delayed fan stop for evacuating residual heat delayed

Version:

-  Environmental: Re-circulate air
-  Electric: Incorporates electric resistors

External control

- E version: Remote control

Applications: Small commercial premises / shops / bars / offices



Control

Control:

Operation

Speeds

Electric battery control

Door contact

LED operation indicator



manual

Two-speed

no

no

yes



manual

Single-speed

One power level

no

yes

Order code

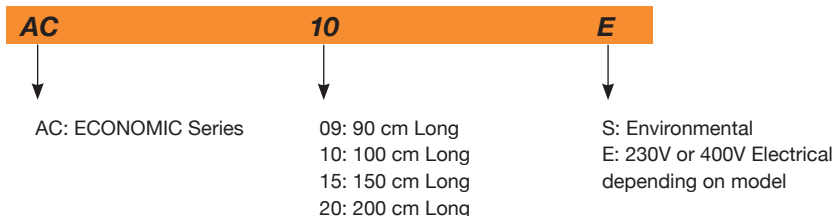

Technical characteristics

Model	Height door (m)	Maximum Airflow (m³/h)	Irradiated NPS dB(A)	Heat Power (kW)	Battery voltage (V)	Battery current (A)	Fan voltage (V)	Fan current (A)	Weight (Kg)
AC-09-S	3	1200	43				1X230	0.65	14.5
AC-10-S	3	1350	44				1X230	0.72	16
AC-15-S	3	2100	46				1X230	0.95	23.5
AC-09-E	3	1000	45	3.5	1x230	15	1X230	0.65	18
AC-10-E	3	1150	46	4.0	1x230	19	1X230	0.72	20
AC-15-E	3	1800	47	5.5	3X400	9	1X230	0.95	31
AC-20-E	3	2400	51	10	3X400	16	1X230	1.38	39

In the three-phase curtain, a three-phase + neutral cable is required

Dimensions in mm

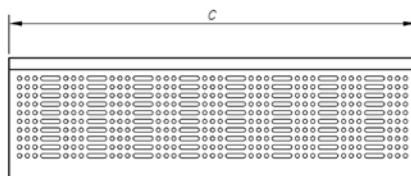
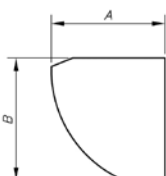

Model	A	B	C
AC-09-S	200	215	900
AC-10-S	200	215	1000
AC-15-S	200	215	1500
AC-09-E	195	220	900
AC-10-E	195	220	1000
AC-15-E	195	220	1500
AC-20-E	195	220	2000

Technical characteristics

Model	Speed (r/min)	Current (A)		Voltage (V)	Installed power (W)	Maximum airflow (m³/h)	NPS dB(A)	Weight approx. (Kg)
		230V	400V					
RECUP/LC-05-F6+F8	2440	2x0.45	-	1x230	2x40	410	45	26
RECUP/LC-08-F6+F8	2440	2x0.45	-	1x230	2x40	620	53	30
RECUP/LC-12-F6+F8	2440	2x0.72	-	1x230	2x150	850	56	34
RECUP/LC-20-F6+F8	2020	2x0.90	-	1x230	2x195	1500	51	63
RECUP/LC-30-F6+F8	2750	2x2.7	-	1x230	2x550	2320	54	72
RECUP/LC-45-F6+F8	1400	-	2x2.8	3x400	2x1100	4400	53	177
RECUP/LC-60-F6+F8	2125	-	2x4.8	3x400	2x2200	5300	57	207
RECUP/LC-05-F7	2440	2x0.45	-	1x230	2x100	540	45	26
RECUP/LC-08-F7	2440	2x0.45	-	1x230	2x100	780	53	30
RECUP/LC-12-F7	2440	2x0.72	-	1x230	2x150	1080	56	34
RECUP/LC-20-F7	2020	2x0.90	-	1x230	2x195	1900	51	63
RECUP/LC-30-F7	2750	2x2.7	-	1x230	2x550	2850	54	72
RECUP/LC-45-F7	1400	-	2x2.8	3x400	2x1100	4500	53	177
RECUP/LC-60-F7	2125	-	2x4.8	3x400	2x2200	5700	57	207
RECUP/LC-05-F7+F9	2440	2x0.45	-	1x230	2x40	380	45	26
RECUP/LC-08-F7+F9	2440	2x0.45	-	1x230	2x40	570	53	30
RECUP/LC-12-F7+F9	2440	2x0.72	-	1x230	2x150	790	56	34
RECUP/LC-20-F7+F9	2020	2x0.90	-	1x230	2x195	1350	51	63
RECUP/LC-30-F7+F9	2750	2x2.7	-	1x230	2x550	2050	54	72
RECUP/LC-45-F7+F9	1400	-	2x2.8	3x400	2x1100	4050	53	177
RECUP/LC-60-F7+F9	2125	-	2x4.8	3x400	2x2200	5000	57	207
RECUP/LC-05-G4	2440	2x0.45	-	1x230	2x100	600	45	26
RECUP/LC-08-G4	2440	2x0.45	-	1x230	2x100	900	53	30
RECUP/LC-12-G4	2440	2x0.72	-	1x230	2x150	1250	56	34
RECUP/LC-20-G4	2020	2x0.90	-	1x230	2x195	2200	51	63
RECUP/LC-30-G4	2750	2x2.7	-	1x230	2x550	3400	54	72
RECUP/LC-45-G4	1400	-	2x2.8	3x400	2x1100	4800	53	177
RECUP/LC-60-G4	2125	-	2x4.8	3x400	2x2200	6100	57	207

Acoustic features

Sound power Lw(A) spectrum in dB(A) via frequency band in Hz.

	63	125	250	500	1000	2000	4000	8000		63	125	250	500	1000	2000	4000	8000
RECUP/LC-05	30	42	45	57	53	50	40	37	RECUP/LC-30	43	56	66	69	67	62	54	45
RECUP/LC-08	38	50	53	65	61	58	48	45	RECUP/LC-45	53	62	65	62	61	60	56	54
RECUP/LC-12	41	53	56	68	64	61	51	48	RECUP/LC-60	51	68	58	59	62	62	60	56
RECUP/LC-20	38	50	53	65	61	58	48	45									

Dimensions in mm

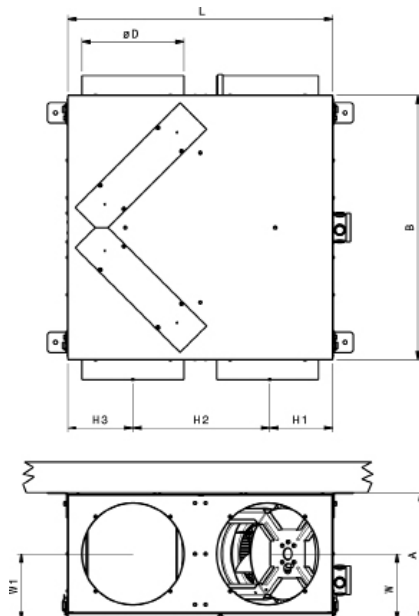

	A	B	L	D	H1	H2	H3	W	W1
RECUP/LC-05	310	575	575	150	131	312	131	164	164
RECUP/LC-08	310	650	650	250	160	330	160	164	164
RECUP/LC-12	330	700	700	250	165	370	165	174	174
RECUP/LC-20	504	900	900	355	240	420	240	252	252
RECUP/LC-30	504	900	900	355	240	420	240	252	252
RECUP/LC-45	580	1520	1520	450	310	900	310	290	290
RECUP/LC-60	580	1520	1520	450	310	900	310	290	290

Characteristic curves

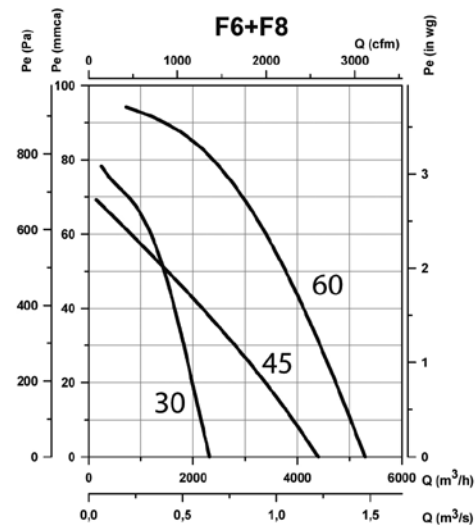
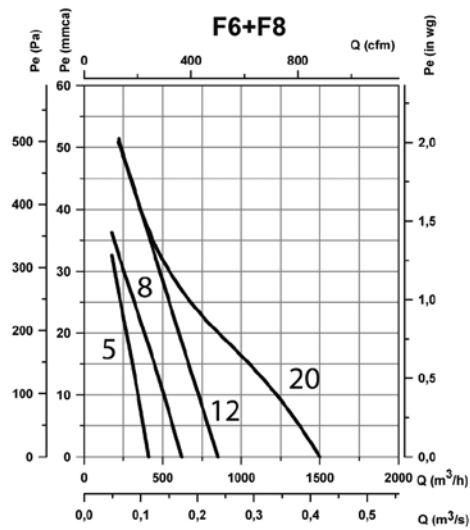
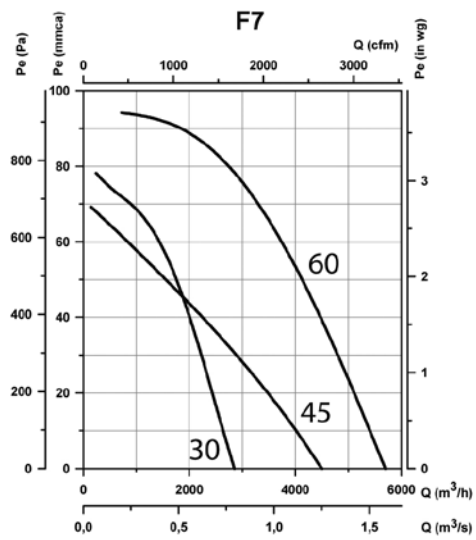
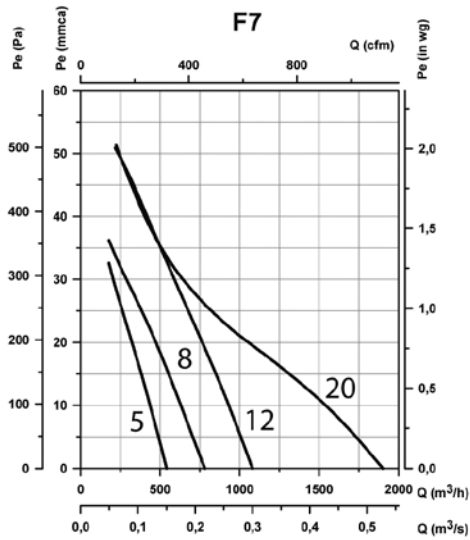
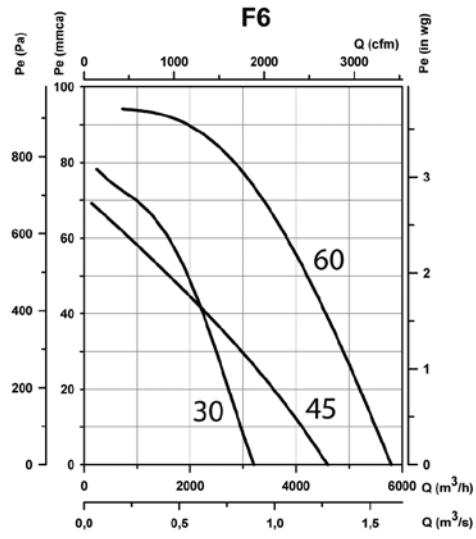
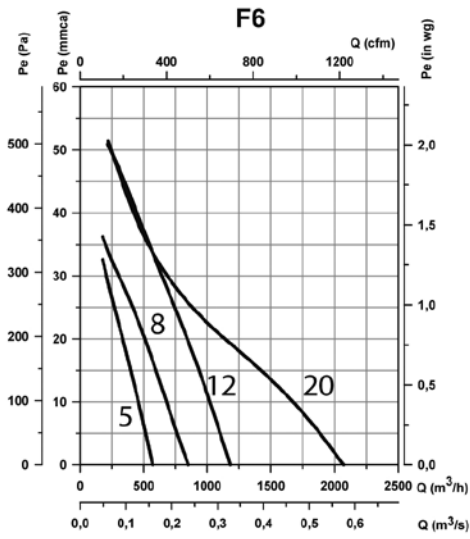

Characteristic curves

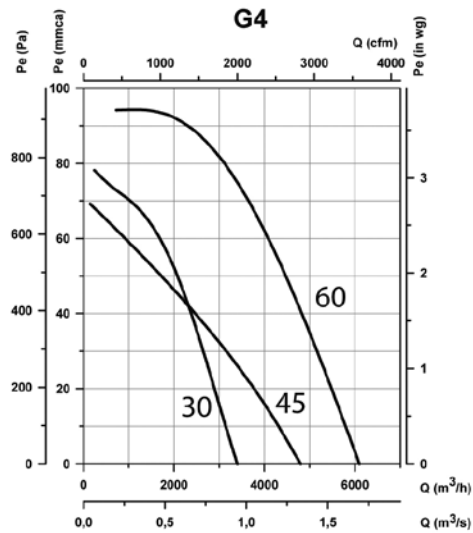
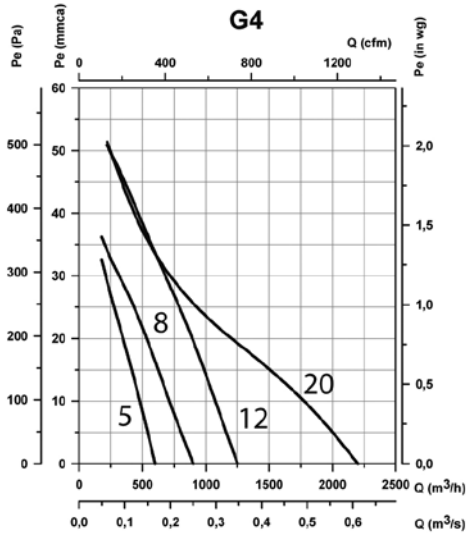
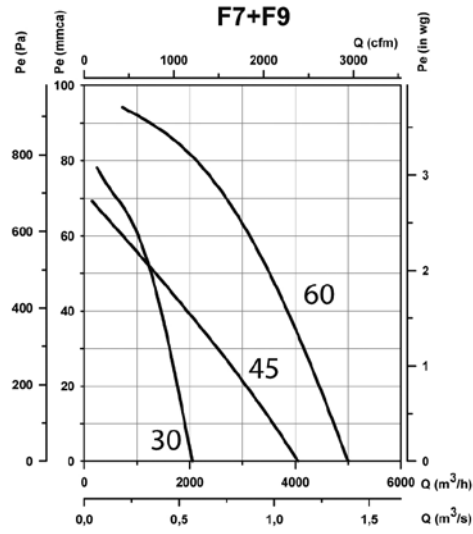
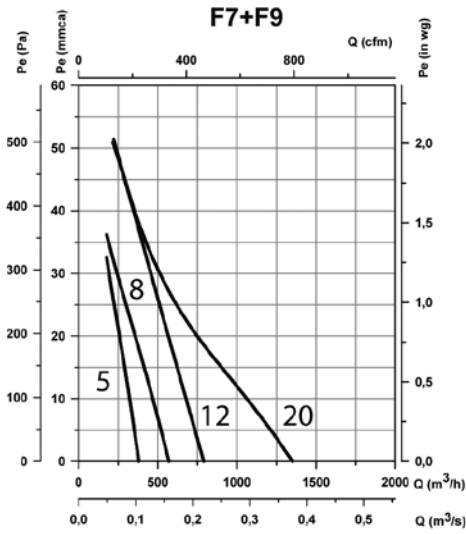

Configurations

Standard delivery configuration C. All models allow inlet and outlet configuration directly at the installation premises, except the 45, 60 model which only allows the air inlet configuration.

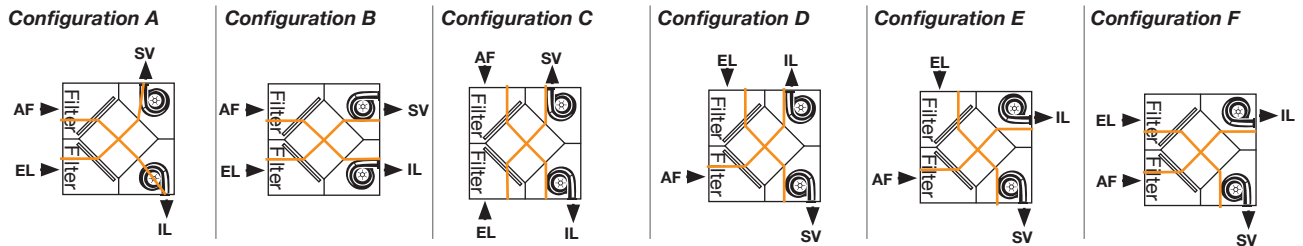

AF: Outside fresh air / IL: Pressurised air to room / SV: Stale air output / EL: Air extraction from room

Top view diagrams, for placement of the equipment in the ceiling. With maintenance access in the bottom panel

Accessories

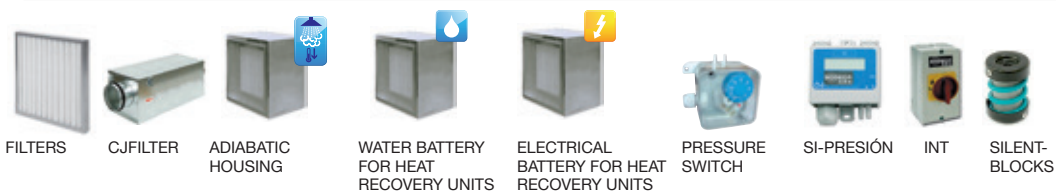



HEADQUARTER

Sodeca, S.L.U.
Pol. Ind. La Barricona
Carrer del Metall, 2
E-17500 Ripoll
Girona, SPAIN
Tel. +34 93 852 91 11
Fax: +34 93 852 90 42
General sales:
comercial@sodeca.com
Export sales:
ventilation@sodeca.com

PRODUCTION PLANT

Sodeca, S.L.U.
Ctra. de Berga, km 0,7
E-08580 Sant Quirze de
Besora
Barcelona, SPAIN
Tel. +34 93 852 91 11
Fax: +34 93 852 90 42
General sales:
comercial@sodeca.com
Export sales:
ventilation@sodeca.com



EUROPE

FINLAND

Sodeca Finland, Oy
HUITTINEN
Sales and Warehouse
Mr. Kai Yli-Sipilä
Metsälinnankatu 26
FI-32700 Huitinen
Tel. + 358 400 320 125
orders.finland@sodeca.com

HELSINKI
Smoke Control Solutions
Mr. Antti Kontkanen
Viilpulantie 9C
FI-00700 Helsinki
Tel. +358 400 237 434
akontkanen@sodeca.com

HYVINKÄÄ
Industrial Applications
Mr. Jaakko Tomperi
Niinistökatu 12
FI-05800 Hyvinkää
Tel. +358 451 651 333
jtomperi@sodeca.com

ITALIA

Marelli Ventilazione, S.R.L.
Viale del Lavoro, 28
37036 San Martino B.A.
(VR), ITALY
Tel. +39 045 87 80 140
vendite@sodeca.com

PORTUGAL

Sodeca Portugal, Unip. Lda.
PORTO
Rua Veloso Salgado 1120/1138
4450-801 Leça de Palmeira
Tel. +351 229 991 100
geral@sodeca.pt

LISBOA
Pq. Emp. da Granja Pav. 29
2625-607 Vialonga
Tel. +351 219 748 491
geral@sodeca.pt

ALGARVE
Rua da Alegria, 33
8200-569 Ferreiras
Tel. +351 289 092 586
geral@sodeca.pt

UNITED KINGDOM

Sodeca Fans UK, Ltd.
Mr. Mark Newcombe
Tamworth Enterprise Centre
Philip Dix House, Corporation
Street, Tamworth, B79 7DN
UNITED KINGDOM
Tel. +44 (0) 1827 216 109
sales@sodeca.co.uk

AMERICA

CHILE

Sodeca Ventiladores, SpA.
Sra. Sofía Ormazábal
Santa Bernardita 12.005
(Esquina con Puerta Sur)
Bodegas 24 a 26,
San Bernardo, Santiago, CHILE
Tel. +56 22 840 5582
ventas.chile@sodeca.com

COLOMBIA

Sodeca Latam, S.A.S.
Sra. Luisa Stella Prieto
Calle7 No. 13 A-44
Manzana 4 Lote1, Montaña
Mosquera, Cundinamarca
Bogotá, COLOMBIA
Tel. +57 1 756 4213
ventascolombia@sodeca.co

PERU

Sodeca Perú, S.A.C.
Sr. Jose Luis Jiménez
C/ Mariscal Jose Luis de
Orbegoso 331. Urb. El pino.
15022, San Luis. Lima, PERÚ
Tel. +51 1 326 24 24
Cel. +51 994671594
comercial@sodeca.pe



HEADQUARTER

Sodeca, S.L.U.
 Pol. Ind. La Barricona
 Carrer del Metall, 2
 E-17500 Ripoll
 Girona, SPAIN
 Tel. +34 93 852 91 11
 Fax: +34 93 852 90 42
 General sales: comercial@sodeca.com
 Export sales: ventilation@sodeca.com

PRODUCTION PLANT

Sodeca, S.L.U.
 Ctra. de Berga, km 0,7
 E-08580 Sant Quirze de Besora
 Barcelona, SPAIN
 Tel. +34 93 852 91 11
 Fax: +34 93 852 90 42
 General sales: comercial@sodeca.com
 Export sales: ventilation@sodeca.com



www.sodeca.com

