



HCH HCT

Extremely robust wall-mounted or tubular axial fans



HCH



HCT

Axial or tubular wall-mounted fans, PL version fitted with a plastic impeller and AL version with an aluminium impeller.

Fan:

- Airflow direction from motor to impeller.
- PL version in fibreglass-reinforced polyamide-6 rots and AL version in cast aluminium. Models 40-2T and HCT-45-2T only in AL version.
- HCH: Sheet steel metal support ring.
- HCT: Tubular casing in sheet steel with external terminal box.

Motor:

- IE3 efficiency motors for powers equal to or higher than 0.75kW except single-phase, 2-speed and 8-pole.
- Class F motors with ball bearings, IP55 protection, except single-phase models from size 45 to size 56, IP54 protection. 1 or 2 speeds, depending on model.

- Single-phase 230V-50Hz and three-phase 230/400V-50Hz (up to 4kW) and 400/690V-50Hz (powers higher than 4kW).
- Operating temperature: -25°C+ 50°C.

Finish:

- Anti-corrosive finish of polyester resin polymerised at 190°C, previously degreased with phosphate-free nanotechnological treatment.

On request:

- Airflow direction from impeller to motor.
- 100% reversible impellers.
- Special windings for different voltages.
- ATEX-certified Category 2.



Order code

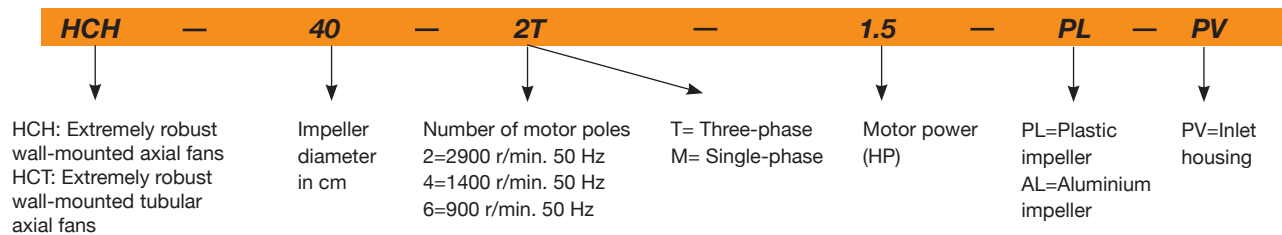

Technical characteristics

Model	Speed (r/min)	Max. admissible current (A)			Installed power (kW)	Maximum flow rate (m³/h)	Sound pressure level dB(A)	Approx. weight (kg)		According to ErP	
		230 V	400 V	690 V				HCH	HCT	HCH	HCT
- HCT 25-2T	2670	0.64	0.37		0.09	1950	64	-	7	-	2015
- HCT 25-2M	2760	0.79			0.09	1950	64	-	7	-	*
- HCT 25-4T	1320	0.65	0.38		0.09	1000	50	-	7	-	Excluded
- HCT 25-4M	1380	0.65			0.10	1000	50	-	7	-	Excluded
- HCT 31-2T	2750	1.21	0.7		0.18	2900	70	-	8	-	2015
- HCT 31-2M	2780	1.42			0.18	2900	70	-	8	-	*
- HCT 31-4T	1320	0.65	0.38		0.09	1550	52	-	8	-	Excluded
- HCT 31-4M	1380	0.65			0.10	1550	52	-	8	-	Excluded
HCH HCT 35-2T	2710	1.92	1.11		0.37	5750	77	9	12	2015	2015
- HCT 35-2M	2780	2.53			0.37	5750	77	-	12	-	2015
HCH HCT 35-4T	1320	0.65	0.38		0.09	3100	59	7	10	2015	2015
- HCT 35-4M	1380	0.65			0.10	3100	59	-	10	-	2015
HCH HCT 40-2T-1.5 IE3	2830	4.03	2.34		1.10	8800	84	18	26	2015	2015
HCH HCT 40-4T-0.33	1350	1.66	0.96		0.25	5150	64	13	21	2015	2015
- HCT 45-2T-2 IE3	2875	5.34	3.07		1.50	10650	86	-	35	-	2015
- HCT 45-2T-3 IE3	2910	7.32	4.21		2.20	12750	88	-	39	-	2015

Technical characteristics

Model	Speed (r/min)	Max. admissible current (A)			Installed power (kW)	Maximum flow rate (m ³ /h)	Sound pressure level dB(A)	Approx. weight (kg)		According to ErP	
		230 V	400 V	690 V				HCH	HCT	HCH	HCT
HCH HCT 45-4T-0.5	1370	2.02	1.17		0.37	7100	68	15	24	2015	2015
HCH HCT 45-4M-0.5	1400	2.76			0.37	7100	68	15	24	2015	2015
HCH - 45-6T-0.33	900	1.51	0.87		0.25	4750	55	14	-	2015	-
- HCT 50-4T-0.75	1380	2.92	1.69		0.55	10400	70	-	28	-	2015
HCH HCT 56-4T-0.75	1380	2.92	1.69		0.55	11050	72	21	33	2015	2015
HCH HCT 56-4T-1 IE3	1420	2.82	1.62		0.75	12950	73	23	35	2015	2015
HCH HCT 56-4T-1.5 IE3	1455	4.07	2.34		1.10	14000	74	30	41	2015	2015
HCH HCT 56-4T-2 IE3	1440	5.41	3.11		1.50	15300	75	36	47	2015	2015
HCH HCT 56-6T-0.33	900	1.51	0.87		0.25	8500	61	18	30	2015	2015
HCH HCT 56-6T-0.5	900	2.24	1.30		0.37	9300	61	20	32	2015	2015
HCH HCT 56-6T-0.75	900	2.99	1.73		0.55	10000	62	22	34	2015	2015
HCH HCT 63-4T-1 IE3	1420	2.82	1.62		0.75	14150	73	28	43	2015	2015
HCH HCT 63-4T-1.5 IE3	1455	4.07	2.34		1.10	17000	74	34	49	2015	2015
HCH HCT 63-4T-2 IE3	1440	5.41	3.11		1.50	18900	75	41	56	2015	2015
HCH HCT 63-4T-3 IE3	1435	7.93	4.56		2.20	22100	76	42	58	2015	2015
HCH HCT 63-4T-4 IE3	1440	10.70	6.15		3.00	25400	77	48	64	2015	2015
HCH HCT 63-6T-0.5	900	2.24	1.30		0.37	12150	64	25	40	2015	2015
HCH HCT 63-6T-0.75	900	2.99	1.73		0.55	12750	65	27	42	2015	2015
HCH HCT 63-6T-1 IE3	940	3.36	1.93		0.75	13800	66	36	51	*	*
HCH HCT 71-4T-1.5 IE3	1455	4.07	2.34		1.10	19750	78	37	56	2015	2015
HCH HCT 71-4T-2 IE3	1440	5.41	3.11		1.50	21100	79	44	63	2015	2015
HCH HCT 71-4T-3 IE3	1435	7.93	4.56		2.20	23950	81	46	65	2015	2015
HCH HCT 71-4T-4 IE3	1440	10.70	6.15		3.00	29400	82	52	71	2015	2015
HCH HCT 71-6T-0.75	900	2.99	1.73		0.55	15150	67	29	49	2015	2015
HCH HCT 71-6T-1 IE3	940	3.36	1.93		0.75	17250	68	39	58	2015	2015
HCH HCT 71-6T-1.5 IE3	945	4.68	2.69		1.10	20950	69	44	63	2015	2015
HCH HCT 80-4T-3 IE3	1435	7.93	4.56		2.20	28000	82	54	73	2015	2015
HCH HCT 80-4T-4 IE3	1440	10.70	6.15		3.00	32700	83	60	79	2015	2015
HCH HCT 80-4T-5.5 IE3	1450	13.90	8.00		4.00	37200	84	62	81	2015	2015
HCH HCT 80-6T-1 IE3	940	3.36	1.93		0.75	20600	71	47	67	2015	2015
HCH HCT 80-6T-1.5 IE3	945	4.68	2.69		1.10	24250	72	52	72	2015	2015
HCH HCT 80-6T-2 IE3	950	6.43	3.70		1.50	28000	73	56	75	2015	2015
HCH HCT 80-6T-3 IE3	950	9.08	5.22		2.20	32500	74	61	80	2015	2015
HCH HCT 90-4T-4 IE3	1440	10.70	6.15		3.00	37750	87	67	95	2015	2015
HCH HCT 90-4T-5.5 IE3	1450	13.90	8.00		4.00	41850	89	69	97	2015	2015
HCH HCT 90-4T-7.5 IE3	1465		10.30	5.97	5.50	47000	91	106	132	2015	2015
HCH HCT 90-4T-10 IE3	1465		13.90	8.06	7.50	53000	92	110	136	2015	2015
HCH HCT 90-6T-3 IE3	950	9.08	5.22		2.20	35000	78	68	96	2015	2015
HCH HCT 90-6T-4 IE3	970	12.00	6.91		3.00	40000	79	88	114	2015	2015
HCH HCT 100-4T-7.5 IE3	1465		10.30	5.97	5.50	52500	92	114	144	2015	2015
HCH HCT 100-4T-10 IE3	1465		13.90	8.06	7.50	58500	93	118	147	2015	2015
HCH HCT 100-4T-15 IE3	1470		20.90	12.10	11.00	68000	94	150	185	2015	2015
HCH HCT 100-4T-20 IE3	1465		27.90	16.20	15.00	71850	95	161	196	2015	2015
HCH HCT 100-6T-3 IE3	950	9.08	5.22		2.20	40500	82	76	107	2015	2015
HCH HCT 100-6T-4 IE3	970	12.00	6.91		3.00	46950	83	96	125	2015	2015
HCH HCT 100-6T-5.5 IE3	960	15.60	8.99		4.00	52000	84	102	131	2015	2015

* Equipment not covered by Directive 2009/125/EC



Erp. (Energy Related Products)

Information on Directive 2009/125/EC can be downloaded from the SODECA website or the QuickFan selector programme.

Accessories

See accessories section.

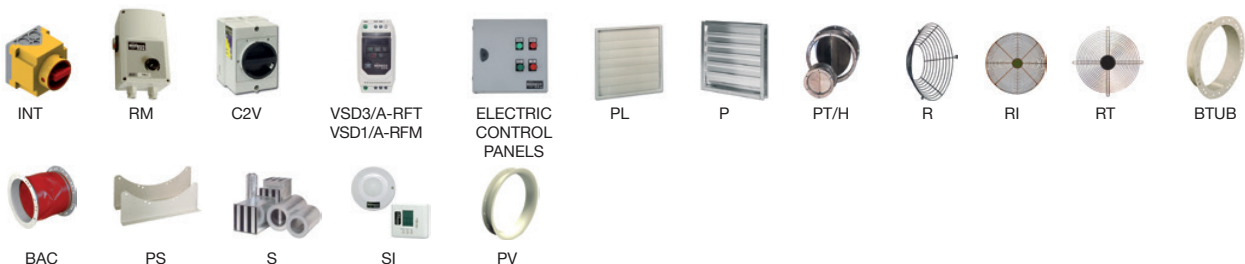

AXIAL FANS AND ROOF-MOUNTED EXTRACT FANS

Acoustic characteristics

The indicated values are determined by measuring the pressure and sound power levels in dB(A) obtained in a free field at a distance equivalent to twice the size of the fan plus the impeller diameter, with a minimum of 1.5 m.

Noise power spectrum Lw(A) in dB(A) frequency band in [Hz]

Model	63	125	250	500	1000	2000	4000	8000	Model	63	125	250	500	1000	2000	4000	8000
25-2	35	50	69	68	69	68	63	54	71-4-1.5	55	75	83	88	90	87	80	69
25-4	21	36	55	54	55	54	49	40	71-4-2	56	76	84	89	91	88	81	70
31-2	41	56	75	74	75	74	69	60	71-4-3	58	78	86	91	93	90	83	72
31-4	23	38	57	56	57	56	51	42	71-4-4	59	79	87	92	94	91	84	73
35-2	48	63	82	81	82	81	76	67	71-6-0.75	44	64	72	77	79	76	69	58
35-4	30	45	64	63	64	63	58	49	71-6-1	45	65	73	78	80	77	70	59
40-2	55	70	89	88	89	88	83	74	71-6-1.5	46	66	74	79	81	78	71	60
40-4	35	50	69	68	69	68	63	54	80-4-3	59	79	87	92	94	91	84	73
45-2-2	51	68	80	88	93	93	89	82	80-4-4	60	80	88	93	95	92	85	74
45-2-3	53	70	82	90	95	95	91	84	80-4-5.5	61	81	89	94	96	93	86	75
45-4-0.5	33	50	62	70	75	75	71	64	80-6-1	48	68	76	81	83	80	73	62
45-6	20	37	49	57	62	62	58	51	80-6-1.5	49	69	77	82	84	81	74	63
50-4	37	54	67	74	79	80	75	68	80-6-2	50	70	78	83	85	82	75	64
56-4-0.75	47	67	75	80	82	79	72	61	80-6-3	51	71	79	84	86	83	76	65
56-4-1	48	68	76	81	83	80	73	62	90-4-4	65	86	93	98	101	97	90	79
56-4-1.5	49	69	77	82	84	81	74	63	90-4-5.5	67	88	95	100	103	99	92	81
56-4-2	50	70	78	83	85	82	75	64	90-4-7.5	69	90	97	102	105	101	94	83
56-6-0.33	36	56	64	69	71	68	61	50	90-4-10	70	91	98	103	106	102	95	84
56-6-0.5	36	56	64	69	71	68	61	50	90-6-3	56	77	84	89	92	88	81	70
56-6-0.75	37	57	65	70	72	69	62	51	90-6-4	57	78	85	90	93	89	82	71
63-4-1	50	70	78	83	85	82	75	64	100-4-7.5	72	92	100	105	107	104	97	86
63-4-1.5	51	71	79	84	86	83	76	65	100-4-10	73	93	101	106	108	105	98	87
63-4-2	52	72	80	85	87	84	77	66	100-4-15	74	94	102	107	109	106	99	88
63-4-3	53	73	81	86	88	85	78	67	100-4-20	75	95	103	108	110	107	100	89
63-4-4	54	74	82	87	89	86	79	68	100-6-3	62	82	90	95	97	94	87	76
63-6-0.5	41	61	69	74	76	73	66	55	100-6-4	63	83	91	96	98	95	88	77
63-6-0.75	42	62	70	75	77	74	67	56	100-6-5.5	64	84	92	97	99	96	89	78
63-6-1	43	63	71	76	78	75	68	57									

Dimensions mm

HCH

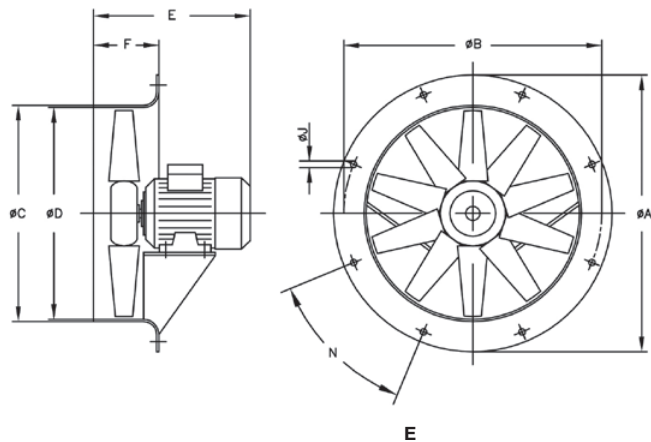

Model	ØA	ØB	ØC	ØD	0.16	0.33	0.5	0.75	1	1.5	2	3	4	5.5	7.5	10	15	20	F	ØJ	N
HCH-35-2	425	395	358	355	-	-	285	-	-	-	-	-	-	-	-	-	-	-	110	10	8x45°
HCH-35-4	425	395	358	355	257	-	-	-	-	-	-	-	-	-	-	-	-	-	110	10	8x45°
HCH-40-2	490	450	414	410	-	-	-	-	-	314	-	-	-	-	-	-	-	-	120	12	8x45°
HCH-40-4	490	450	414	410	-	305	-	-	-	-	-	-	-	-	-	-	-	-	120	12	8x45°
HCH-45-4	540	500	464	460	-	-	295	-	-	-	-	-	-	-	-	-	-	-	120	12	8x45°
HCH-45-6	540	500	464	460	-	295	-	-	-	-	-	-	-	-	-	-	-	-	120	12	8x45°
HCH-56-4	660	620	564	560	-	-	-	316	316	330	354	-	-	-	-	-	-	-	120	12	12x30°
HCH-56-6	660	620	564	560	-	298	316	316	-	-	-	-	-	-	-	-	-	-	120	12	12x30°
HCH-63-4	730	690	645	640	-	-	-	-	332	340	366	420	420	-	-	-	-	-	150	12	12x30°
HCH-63-6	730	690	645	640	-	-	332	332	340	-	-	-	-	-	-	-	-	-	150	12	12x30°
HCH-71-4	810	770	715	710	-	-	-	-	-	334	360	430	430	-	-	-	-	-	150	12	16x22°30'
HCH-71-6	810	770	715	710	-	-	-	323	334	360	-	-	-	-	-	-	-	-	150	12	16x22°30'
HCH-80-4	900	860	805	800	-	-	-	-	-	-	425	425	445	-	-	-	-	-	180	12	16x22°30'
HCH-80-6	900	860	805	800	-	-	-	-	360	386	425	445	-	-	-	-	-	-	180	12	16x22°30'
HCH-90-4	1015	970	906	900	-	-	-	-	-	-	-	436	430	465	465	-	-	-	180	12	16x22°30'
HCH-90-6	1015	970	906	900	-	-	-	-	-	-	436	430	465	-	-	-	-	-	180	12	16x22°30'
HCH-100-4	1115	1070	1006	1000	-	-	-	-	-	-	-	-	-	-	503	503	612	612	200	15	16x22°30'
HCH-100-6	1115	1070	1006	1000	-	-	-	-	-	-	440	503	503	-	-	-	-	-	200	15	16x22°30'

Dimensions mm

HCT

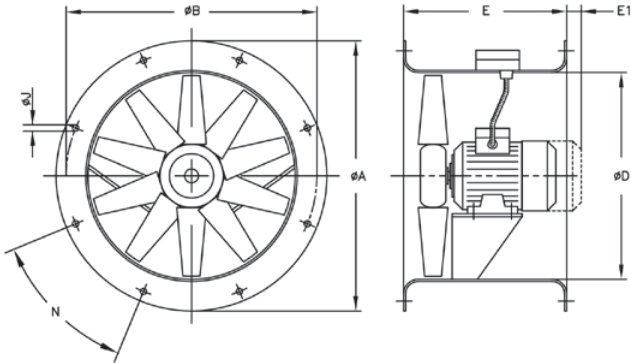

Model	ØA	ØB	ØD	E	E1	ØJ	N
HCT-25	310	280	240	230	10	10	4x90°
HCT-31	350	320	280	270	-	10	4x90°
HCT-35	425	395	355	280	-	10	8x45°
HCT-40	490	450	410	320	-	12	8x45°
HCT-45	540	500	460	360	-	12	8x45°
HCT-50	600	560	514	360	-	12	12x30°
HCT-56	660	620	560	400	-	12	12x30°
HCT-63	730	690	640	430	-	12	12x30°
HCT-71	810	770	710	500	-	12	16x22°30'
HCT-80	900	860	800	500	-	12	16x22°30'
HCT-90	1015	970	900	500	-	15	16x22°30'
HCT-100	1115	1070	1000	600	-	15	16x22°30'
HCT-100-4T-15	1115	1070	1000	700	-	15	16x22°30'
HCT-100-4T-20	1115	1070	1000	700	-	15	16x22°30'

Characteristic curves

Q= Flow rate in m³/h, m³/s and cfm.

Pe= Static pressure in mm H₂O, Pa and inwg.

2-Pole=3000 r/min

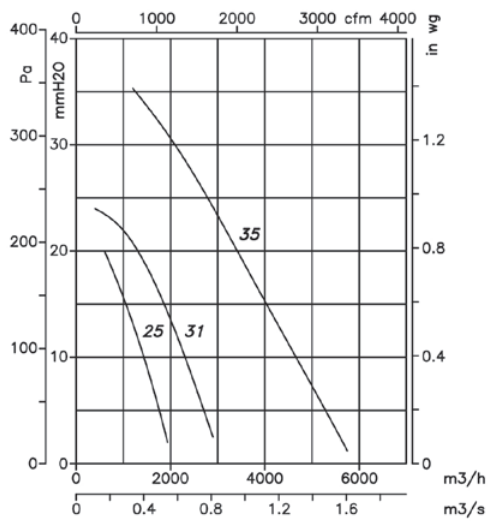

2-Pole=3000 r/min

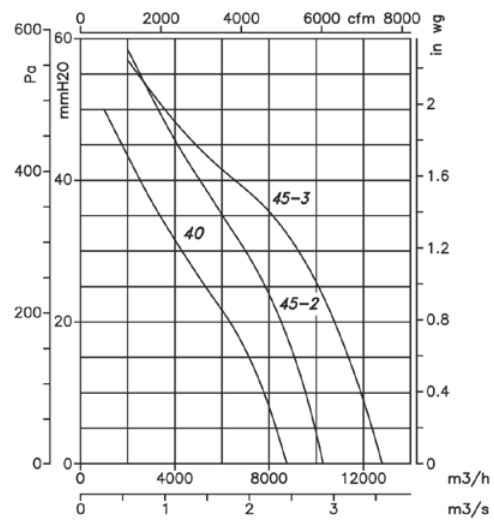

4-Pole=1500 r/min

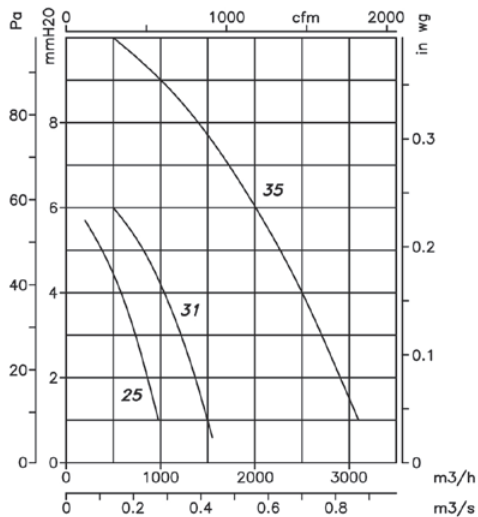

4-Pole=1500 r/min

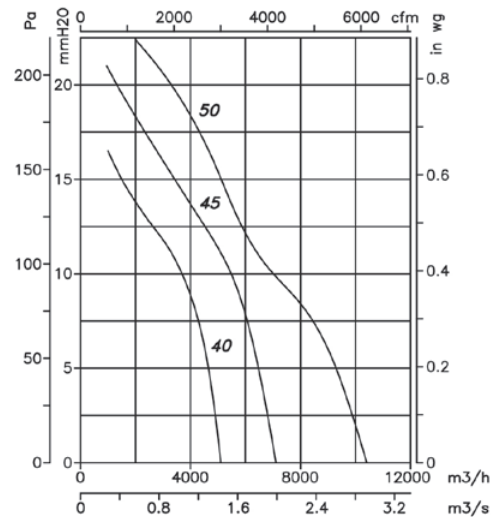

AXIAL FANS AND ROOF-MOUNTED EXTRACT FANS

Characteristic curves

Q= Flow rate in m³/h, m³/s and cfm.

Pe= Static pressure in mm H₂O, Pa and inwg.

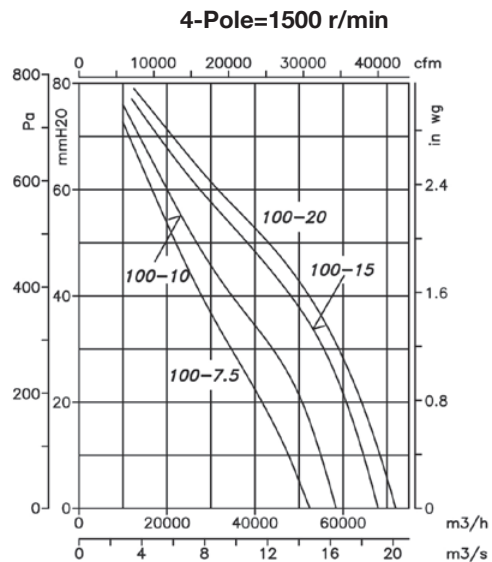
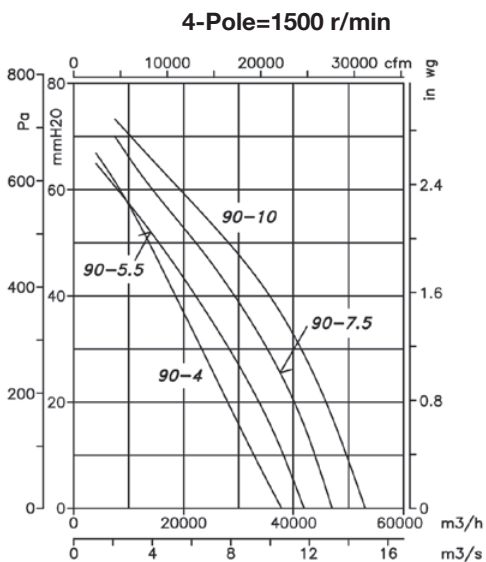
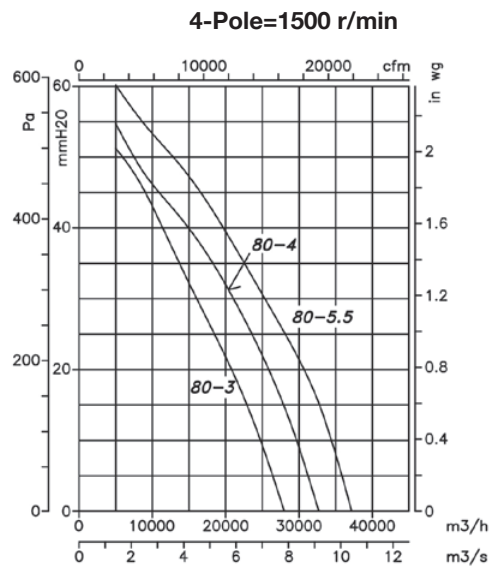
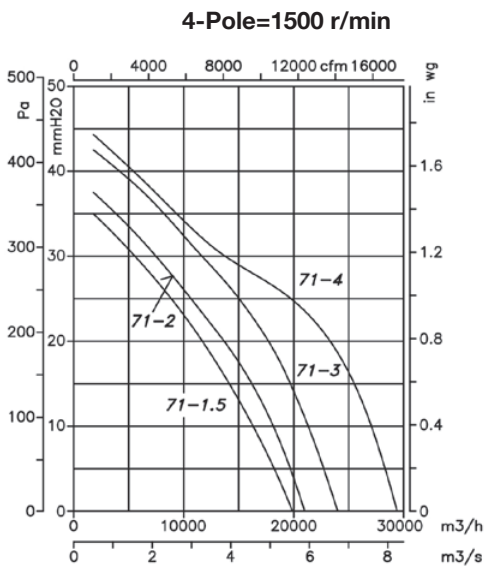
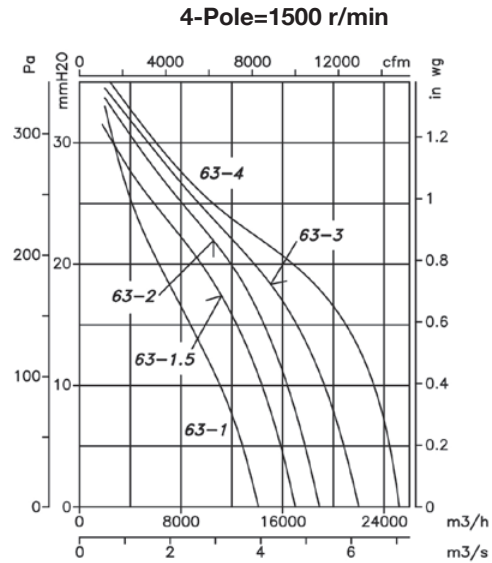
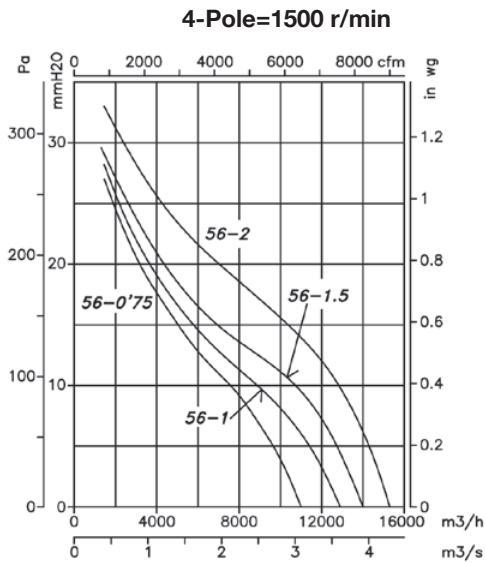

Characteristic curves

Q= Flow rate in m³/h, m³/s and cfm.

Pe= Static pressure in mm H₂O, Pa and inwg.

