

CJTHT/ATEX

400 °C/2h and 300 °C/2h axial exhaust units with ATEX certification



Extraction units with axial fans to work immersed in fire risk areas.

Fan:

- Fan with tubular sheet steel casing.
- Galvanised sheet steel structure with thermal insulation and acoustic insulation.
- Variable angle impeller made of cast aluminium.
- Approved in accordance with standard EN 12101-3, with certifications no.: 0370- CPR-0312 (F400) and 0370-CPR-0974 (F300).

Motor:

- Class H motors for S1 continuous operation and S2 emergency use. With ball bearings, IP55 protection and 1 or 2 speeds, depending on model.
- Motors with IE3 efficiency for powers equal to or greater than 0.75 kW, except single-phase, 2-speed and 8-pole.
- Three-phase 230/400 V 50 Hz (up to 3 kW) and 400/690 V 50 Hz (powers greater than 3 kW).

- Maximum temperature of air to be carried: S1 -20 °C +40 °C continuous service, also suitable for warm climates with temperatures up to 50 °C. S2 operation, 300 °C/2h, 400 °C/2h.

Finish:

- Fan: anti-corrosive in polyester resin polymerized at 190 °C, after degreasing with phosphate-free nanotechnological treatment.
- Box: anti-corrosive in galvanised sheet steel.

Available versions:

- CJTHT: axial fans with acoustically insulated boxes.
- CJTHT/ATEX: axial fans with acoustically insulated boxes and ATEX certification, category 3 Ex II3G for zone 2 (only 400 °C/2h and 300 °C/2h).
- CJTHT/PLUS Axial fans with acoustic attenuators.

On request:

- Airflow direction from impeller to motor.
- 100% reversible impellers.

Order code

From size 40 to size 100

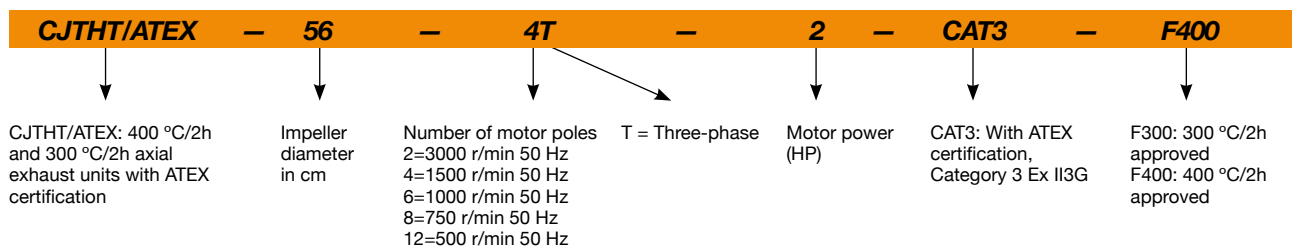

Size 125

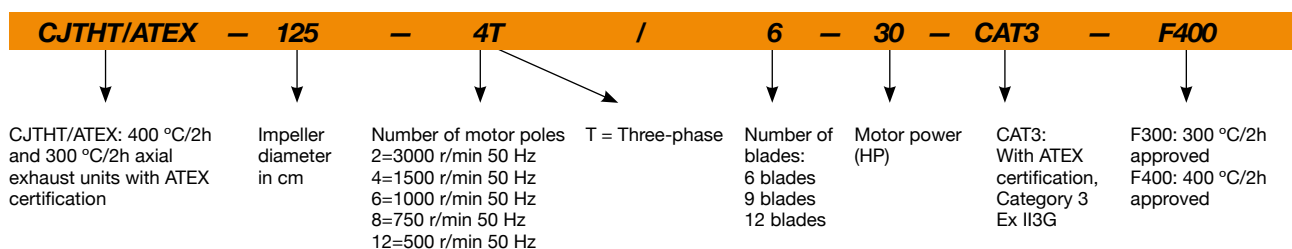

Technical characteristics

Model	Speed (r/min)	Maximum admissible current (A)			Installed power (kW)	Blade tilt angle (°)	Maximum flow rate (m ³ /h)	Sound pressure level ¹ dB (A)	Approx. weight (Kg)
		230V	400V	690V					
CJTHT/ATEX-40-2/4T-1.5/CAT3	2920 / 1445		2.89 / 1.04		1.10 / 0.25	20	7040 / 3480	71 / 56	50
CJTHT/ATEX-40-4T-0.75/CAT3	1420	2.84	1.64		0.55	32	4820	55	41
CJTHT/ATEX-40-6T-0.75/CAT3	930	2.90	1.75		0.55	32	3150	46	49
CJTHT/ATEX-40-6/12T-0.75/CAT3	940 / 455		2.35 / 1.15		0.60 / 0.15	32	3150 / 1520	46 / 31	53
CJTHT/ATEX-45-2/4T-2/CAT3	2940 / 1465		3.58 / 1.19		1.50 / 0.37	16	9400 / 4680	71 / 56	53
CJTHT/ATEX-45-4T-0.75/CAT3	1420	2.84	1.64		0.55	36	7470	58	43
CJTHT/ATEX-45-6T-0.75/CAT3	930	2.90	1.75		0.55	30	4460	48	51
CJTHT/ATEX-45-6/12T-0.75/CAT3	940 / 455		2.35 / 1.15		0.60 / 0.15	30	4460 / 2150	48 / 33	55
CJTHT/ATEX-50-4T-0.75/CAT3	1420	2.84	1.64		0.55	22	8390	60	48
CJTHT/ATEX-50-6T-0.75/CAT3	930	2.90	1.75		0.55	32	7030	52	52
CJTHT/ATEX-56-4T-1/CAT3	1420	3.08	1.79		0.75	22	11280	63	59
CJTHT/ATEX-56-4T-1.5/CAT3	1420	4.10	2.37		1.10	30	13550	63	61
CJTHT/ATEX-56-4/8T-1.5/CAT3	1440 / 705		2.69 / 1.12		1.10 / 0.25	30	13550 / 6610	63 / 48	65
CJTHT/ATEX-56-4T-2/CAT3	1425	5.89	3.38		1.50	36	15030	64	63
CJTHT/ATEX-56-6T-0.75/CAT3	930	2.90	1.75		0.55	38	10140	54	61
CJTHT/ATEX-56-6/12T-0.75/CAT3	940 / 455		2.35 / 1.15		0.60 / 0.15	38	10140 / 4890	54 / 39	65
CJTHT/ATEX-63-4T-1/CAT3	1420	3.08	1.79		0.75	14	15190	67	63
CJTHT/ATEX-63-4T-1.5/CAT3	1420	4.10	2.37		1.10	20	17800	66	66
CJTHT/ATEX-63-4/8T-1.5/CAT3	1440 / 705		2.69 / 1.12		1.10 / 0.25	20	17800 / 8680	66 / 51	69
CJTHT/ATEX-63-4T-2/CAT3	1425	5.89	3.38		1.50	24	19280	66	67
CJTHT/ATEX-63-4/8T-2/CAT3	1415 / 715		3.40 / 1.65		1.50 / 0.30	24	19280 / 9740	66 / 52	74
CJTHT/ATEX-63-4T-3/CAT3	1435	7.86	4.52		2.20	32	22170	68	73
CJTHT/ATEX-63-4/8T-3/CAT3	1415 / 700		4.80 / 1.85		2.20 / 0.45	32	22170 / 10930	68 / 53	87
CJTHT/ATEX-63-4T-4/CAT3	1430	11.01	6.33		3.00	38	24240	69	78
CJTHT/ATEX-63-4/8T-4/CAT3	1425 / 710		6.45 / 2.28		3.00 / 0.60	38	24240 / 12070	69 / 54	91
CJTHT/ATEX-63-6T-0.75/CAT3	930	2.90	1.75		0.55	28	13590	57	66
CJTHT/ATEX-63-6/12T-0.75/CAT3	940 / 455		2.35 / 1.15		0.60 / 0.15	28	13590 / 6550	57 / 42	69
CJTHT/ATEX-63-6T-1/CAT3	940	3.36	1.93		0.75	38	15890	58	67
CJTHT/ATEX-63-6/12T-1/CAT3	935 / 455		3.75 / 2.76		0.80 / 0.20	38	15890 / 7700	58 / 43	71
CJTHT/ATEX-71-4T-1.5/CAT3	1420	4.10	2.37		1.10	12	19480	71	82
CJTHT/ATEX-71-4/8T-1.5/CAT3	1440 / 705		2.69 / 1.12		1.10 / 0.25	12	19480 / 9500	71 / 56	86
CJTHT/ATEX-71-4T-2/CAT3	1425	5.89	3.38		1.50	14	20920	70	84
CJTHT/ATEX-71-4/8T-2/CAT3	1415 / 715		3.40 / 1.65		1.50 / 0.30	14	20920 / 10570	70 / 56	91
CJTHT/ATEX-71-4T-3/CAT3	1435	7.86	4.52		2.20	22	25110	70	90
CJTHT/ATEX-71-4/8T-3/CAT3	1415 / 700		4.80 / 1.85		2.20 / 0.45	22	25110 / 12380	70 / 55	103
CJTHT/ATEX-71-4T-4/CAT3	1430	11.01	6.33		3.00	28	27480	70	95
CJTHT/ATEX-71-4/8T-4/CAT3	1425 / 710		6.45 / 2.28		3.00 / 0.60	28	27480 / 13680	70 / 55	108
CJTHT/ATEX-71-6T-0.75/CAT3	930	2.90	1.75		0.55	20	16100	60	82
CJTHT/ATEX-71-6/12T-0.75/CAT3	940 / 455		2.35 / 1.15		0.60 / 0.15	20	16100 / 7760	60 / 45	86
CJTHT/ATEX-71-6T-1/CAT3	940	3.36	1.93		0.75	26	17310	60	84
CJTHT/ATEX-71-6/12T-1/CAT3	935 / 455		3.75 / 2.76		0.80 / 0.20	26	17310 / 8390	60 / 45	87
CJTHT/ATEX-71-6T-1.5/CAT3	945	4.73	2.72		1.10	34	19930	61	86
CJTHT/ATEX-71-6/12T-1.5/CAT3	940 / 460		3.52 / 2.00		1.20 / 0.30	34	19930 / 9760	61 / 46	97
CJTHT/ATEX-80-4T-3/CAT3	1435	7.86	4.52		2.20	12	25460	75	98
CJTHT/ATEX-80-4/8T-3/CAT3	1415 / 700		4.80 / 1.85		2.20 / 0.45	12	25460 / 12550	75 / 60	111
CJTHT/ATEX-80-4T-4/CAT3	1430	11.01	6.33		3.00	16	30270	74	103
CJTHT/ATEX-80-4/8T-4/CAT3	1425 / 710		6.45 / 2.28		3.00 / 0.60	16	30270 / 15070	74 / 59	115
CJTHT/ATEX-80-4T-5.5/CAT3	1440		7.95 / 4.61		4.00	18	32770	73	113
CJTHT/ATEX-80-4/8T-5.5/CAT3	1455 / 720		7.88 / 2.87		3.80 / 1.00	18	32770 / 16160	73 / 58	147
CJTHT/ATEX-80-6T-1.5/CAT3	945	4.73	2.72		1.10	18	21470	63	95
CJTHT/ATEX-80-6/12T-1.5/CAT3	940 / 460		3.52 / 2.00		1.20 / 0.30	18	21470 / 10510	63 / 48	105
CJTHT/ATEX-80-6T-2/CAT3	945	6.25	3.62		1.50	26	25970	64	99
CJTHT/ATEX-80-6/12T-2/CAT3	960 / 470		4.46 / 3.43		1.60 / 0.40	26	25970 / 12710	64 / 49	113
CJTHT/ATEX-80-6T-3/CAT3	950	9.78	5.62		2.20	32	29930	65	113

Technical characteristics

Model	Speed (r/min)	Maximum admissible current (A)			Installed power (kW)	Blade tilt angle (°)	Maximum flow rate (m³/h)	Sound pressure level¹ dB (A)	Approx. weight (Kg)
		230V	400V	690V					
CJTHT/ATEX-80-6/12T-3/CAT3	940 / 475		5.62 / 3.32		2.20 / 0.55	32	29930 / 15120	65 / 51	118
CJTHT/ATEX-80-8T-0.75/CAT3	700	3.48	2.00		0.55	20	17540	57	99
CJTHT/ATEX-80-8T-1/CAT3	710	5.06	2.92		0.75	28	20680	58	111
CJTHT/ATEX-90-4T-4/CAT3	1430	11.01	6.33		3.00	8	33580	79	127
CJTHT/ATEX-90-4/8T-4/CAT3	1425 / 710		6.45 / 2.28		3.00 / 0.60	8	33580 / 16720	79 / 64	139
CJTHT/ATEX-90-4T-5.5/CAT3	1440		7.95	4.61	4.00	12	38890	78	137
CJTHT/ATEX-90-4/8T-5.5/CAT3	1455 / 720		7.88 / 2.87		3.80 / 1.00	12	38890 / 19170	78 / 63	171
CJTHT/ATEX-90-4T-7.5/CAT3	1460		10.40	6.04	5.50	18	46140	77	171
CJTHT/ATEX-90-4/8T-7.5/CAT3	1455 / 725		11.40 / 3.86		5.50 / 1.10	18	46140 / 22910	77 / 62	190
CJTHT/ATEX-90-4T-10/CAT3	1460		14.20	8.17	7.50	22	50140	76	208
CJTHT/ATEX-90-4/8T-10/CAT3	1455 / 725		15.10 / 5.16		7.50 / 1.50	22	50140 / 24900	76 / 61	198
CJTHT/ATEX-90-6T-2/CAT3	945	6.25	3.62		1.50	16	28780	66	123
CJTHT/ATEX-90-6/12T-2/CAT3	960 / 470		4.46 / 3.43		1.60 / 0.40	16	28780 / 14090	66 / 51	137
CJTHT/ATEX-90-6T-3/CAT3	950	9.78	5.62		2.20	24	34000	66	137
CJTHT/ATEX-90-6/12T-3/CAT3	940 / 475		5.62 / 3.32		2.20 / 0.55	24	34000 / 17180	66 / 52	142
CJTHT/ATEX-90-6T-4/CAT3	970	12.80	6.36		3.00	30	38910	69	171
CJTHT/ATEX-90-6/12T-4/CAT3	970 / 485		7.37 / 3.53		2.80 / 0.70	30	38910 / 19460	69 / 54	171
CJTHT/ATEX-90-8T-1/CAT3	710	5.06	2.92		0.75	18	22910	60	135
CJTHT/ATEX-90-8T-2/CAT3	700	7.32	4.21		1.50	30	29490	63	139
CJTHT/ATEX-90-8T-3/CAT3	710	9.30	5.35		2.20	32	30850	64	171
CJTHT/ATEX-100-4T-7.5/CAT3	1460		10.40	6.04	5.50	10	46870	82	179
CJTHT/ATEX-100-4/8T-7.5/CAT3	1455 / 725		11.40 / 3.86		5.50 / 1.10	10	46870 / 23270	82 / 67	198
CJTHT/ATEX-100-4T-10/CAT3	1460		14.20	8.17	7.50	16	57420	79	216
CJTHT/ATEX-100-4/8T-10/CAT3	1455 / 725		15.10 / 5.16		7.50 / 1.50	14	54710 / 27170	80 / 65	206
CJTHT/ATEX-100-4T-15/CAT3	1460		20.70	11.99	11.00	22	66300	79	251
CJTHT/ATEX-100-4/8T-15/CAT3	1470 / 730		20.70 / 7.19		11.00 / 3.00	22	66300 / 32880	79 / 64	251
CJTHT/ATEX-100-4T-20/CAT3	1460		27.80	16.03	15.00	28	76160	80	258
CJTHT/ATEX-100-4/8T-20/CAT3	1470 / 725		31.72 / 11.75		15.00 / 3.80	28	76160 / 37560	80 / 65	258
CJTHT/ATEX-100-4T/9-15/CAT3	1460		20.70	11.99	11.00	18	55345	80	260
CJTHT/ATEX-100-4T/9-20/CAT3	1460		27.80	16.03	15.00	22	63265	80	268
CJTHT/ATEX-100-4T/9-25/CAT3	1475		35.40	20.39	18.50	26	70625	80	308
CJTHT/ATEX-100-4T/9-30/CAT3	1475		42.20	24.44	22.00	30	74845	82	316
CJTHT/ATEX-100-6T-3/CAT3	950	9.78	5.62		2.20	16	37620	70	145
CJTHT/ATEX-100-6/12T-3/CAT3	940 / 475		5.62 / 3.32		2.20 / 0.55	16	37620 / 19000	70 / 56	150
CJTHT/ATEX-100-6T-4/CAT3	970	12.80	6.36		3.00	20	41180	69	179
CJTHT/ATEX-100-6/12T-4/CAT3	970 / 485		7.37 / 3.53		2.80 / 0.70	20	41180 / 20590	69 / 54	179
CJTHT/ATEX-100-6T-5.5/CAT3	970		8.37	4.82	4.00	26	47780	70	187
CJTHT/ATEX-100-6T/9-5.5/CAT3	970		11.00	6.35	4.00	20	39020	70	196
CJTHT/ATEX-100-6T/9-7.5/CAT3	970		12.30	7.07	5.50	26	46765	71	200
CJTHT/ATEX-100-6T/9-10/CAT3	970		15.20	8.83	7.50	34	52255	74	225
CJTHT/ATEX-125-4T/6-20/CAT3	1455		27.80	16.03	15.00	10	78610	87	466
CJTHT/ATEX-125-4/8T/6-20/CAT3	1455 / 720		31.72 / 11.75		15.00 / 3.80	10	78610 / 38770	87 / 72	485
CJTHT/ATEX-125-4T/6-25/CAT3	1470		35.40	20.39	18.50	14	92000	86	549
CJTHT/ATEX-125-4/8T/6-27/CAT3	1470 / 730		39.70 / 14.10		20.00 / 5.00	16	98100 / 48550	85 / 70	557
CJTHT/ATEX-125-4T/6-30/CAT3	1470		42.20	24.44	22.00	16	98830	85	554
CJTHT/ATEX-125-4/8T/6-37/CAT3	1480 / 740		54.55 / 18.50		28.00 / 6.50	20	110250 / 54940	85 / 70	633
CJTHT/ATEX-125-4T/6-40/CAT3	1475		55.19	31.87	30.00	22	117000	85	606
CJTHT/ATEX-125-4T/6-50/CAT3	1480		66.40	38.26	37.00	26	130450	85	734
CJTHT/ATEX-125-4T/6-60/CAT3	1475		80.90	46.90	45.00	28	135820	85	747
CJTHT/ATEX-125-4T/6-75/CAT3	1480		98.60	57.20	55.00	34	152100	88	828
CJTHT/ATEX-125-4T/9-25/CAT3	1470		35.40	20.39	18.50	10	79680	87	558
CJTHT/ATEX-125-4T/9-30/CAT3	1470		42.20	24.44	22.00	12	88290	86	563
CJTHT/ATEX-125-4/8T/9-27/CAT3	1470 / 730		39.70 / 14.10		20.00 / 5.00	12	88290 / 43690	86 / 71	566
CJTHT/ATEX-125-4/8T/9-37/CAT3	1480 / 740		54.55 / 18.50		28.00 / 6.50	16	104040 / 51840	85 / 70	642

Technical characteristics

Model	Speed (r/min)	Maximum admissible current (A)			Installed power (kW)	Blade tilt angle (°)	Maximum flow rate (m³/h)	Sound pressure level¹ dB (A) Inlet	Approx. weight (Kg)
		230V	400V	690V					
CJTHT/ATEX-125-4T/9-40/CAT3	1475		55.19	31.87	30.00	16	104040	85	615
CJTHT/ATEX-125-4T/9-50/CAT3	1480		66.40	38.26	37.00	20	118350	85	743
CJTHT/ATEX-125-4T/9-60/CAT3	1475		80.90	46.90	45.00	24	134970	85	756
CJTHT/ATEX-125-4T/9-75/CAT3	1480		98.60	57.20	55.00	28	146770	86	837
CJTHT/ATEX-125-4T/9-100/CAT3	1480		128.00	74.22	75.00	34	158560	88	998
CJTHT/ATEX-125-4T/12-50/CAT3	1480		66.80	38.70	37.00	18	101660	86	752
CJTHT/ATEX-125-4T/12-60/CAT3	1475		80.90	46.90	45.00	20	109180	86	765
CJTHT/ATEX-125-4T/12-75/CAT3	1480		98.60	57.20	55.00	26	131240	86	846
CJTHT/ATEX-125-4T/12-100/CAT3	1480		128.00	74.22	75.00	32	154100	88	1016
CJTHT/ATEX-125-6T/6-5.5/CAT3	940		8.37	4.82	4.00	10	51300	77	402
CJTHT/ATEX-125-6T/6-7.5/CAT3	960		12.30	7.07	5.50	14	60640	75	410
CJTHT/ATEX-125-6/12T/6-7.5/CAT3	980 / 485		14.50 / 5.17		5.50 / 1.00	14	60640 / 30010	75 / 60	454
CJTHT/ATEX-125-6T/6-10/CAT3	970		15.20	8.83	7.50	20	72250	74	458
CJTHT/ATEX-125-6/12T/6-10/CAT3	975 / 490		13.6 / 5.69		7.20 / 1.80	20	72250 / 36310	74 / 60	466
CJTHT/ATEX-125-6T/6-15/CAT3	970		22.50	13.07	11.00	26	85450	74	475
CJTHT/ATEX-125-6/12T/6-15/CAT3	975 / 485		23.1 / 8.41		11.00 / 3.00	26	85450 / 42510	74 / 59	566
CJTHT/ATEX-125-6T/6-20/CAT3	970		29.00	16.78	15.00	30	92860	76	542
CJTHT/ATEX-125-6/12T/6-24/CAT3	980 / 485		41.60 / 13.21		17.60 / 2.85	34	99650 / 49320	78 / 63	631
CJTHT/ATEX-125-6T/9-10/CAT3	970		15.20	8.83	7.50	14	63490	77	467
CJTHT/ATEX-125-6/12T/9-10/CAT3	975 / 490		13.6 / 5.69		7.20 / 1.80	14	63490 / 31910	77 / 63	475
CJTHT/ATEX-125-6T/9-15/CAT3	970		22.50	13.07	11.00	20	77550	75	484
CJTHT/ATEX-125-6/12T/9-15/CAT3	975 / 485		23.1 / 8.41		11.00 / 3.00	20	77550 / 38580	75 / 60	575
CJTHT/ATEX-125-6T/9-20/CAT3	970		29.00	16.78	15.00	26	92950	75	551
CJTHT/ATEX-125-6/12T/9-24/CAT3	980 / 485		41.60 / 13.21		17.60 / 2.85	30	98530 / 48760	76 / 61	640
CJTHT/ATEX-125-6T/9-25/CAT3	975		36.10	20.77	18.50	32	101450	77	627
CJTHT/ATEX-125-6T/9-30/CAT3	975		42.30	24.35	22.00	36	106525	80	638
CJTHT/ATEX-125-6T/12-10/CAT3	970		15.20	8.83	7.50	12	49630	79	476
CJTHT/ATEX-125-6T/12-15/CAT3	970		22.50	13.07	11.00	18	67315	77	493
CJTHT/ATEX-125-6T/12-20/CAT3	970		29.00	16.78	15.00	24	81840	76	560
CJTHT/ATEX-125-6T/12-25/CAT3	975		36.10	20.77	18.50	30	96765	77	636
CJTHT/ATEX-125-6T/12-30/CAT3	975		42.30	24.35	22.00	32	102040	78	647
CJTHT/ATEX-125-6T/12-40/CAT3	985		56.00	32.50	30.00	34	106355	79	762

1 The noise level values are pressures in dB(A) measured at a distance of 3 metres in a free field.

Acoustic characteristics

Sound power spectrum Lw(A) in dB(A) per Hz frequency band
Values measured at inlet with maximum flow rate

	63	125	250	500	1000	2000	4000	8000		63	125	250	500	1000	2000	4000	8000
40-2-1.5	47	63	75	83	88	86	82	75	56-12-0.75 (2V)	29	39	49	53	54	52	45	37
40-4-1.5 (2V)	32	48	60	68	73	71	67	60	63-4-1	48	64	76	82	84	81	74	66
40-4-0.75	37	53	63	70	71	68	67	68	63-4-1.5	47	63	75	81	83	80	73	65
40-6-0.75	28	44	54	61	62	59	58	59	63-8-1.5 (2V)	31	47	59	65	67	64	57	49
40-12-0.75 (2V)	12	28	38	45	46	43	42	43	63-4-2	54	66	75	81	81	81	75	67
45-2-2	47	60	74	86	87	86	82	74	63-8-2 (2V)	39	51	60	66	66	66	60	52
45-4-2 (2V)	32	45	59	71	72	71	67	59	63-4-3	56	68	77	83	83	83	77	69
45-4-0.75	47	59	67	73	73	73	68	60	63-8-3 (2V)	41	53	62	68	68	68	62	54
45-6-0.75	37	49	57	63	63	63	58	50	63-4-4	57	69	78	84	84	84	78	70
45-12-0.75 (2V)	21	33	41	47	47	47	42	34	63-8-4 (2V)	42	54	63	69	69	69	63	55
50-4-0.75	49	61	69	75	75	75	70	62	63-6-0.75	48	58	68	72	73	71	64	56
50-6-0.75	41	53	61	67	67	67	62	54	63-12-0.75 (2V)	32	42	52	56	57	55	48	40
56-4-1	51	63	72	78	78	78	72	64	63-6-1	49	59	69	73	74	72	65	57
56-4-1.5	51	63	72	78	78	78	72	64	63-12-1 (2V)	33	43	53	57	58	56	49	41
56-8-1.5 (2V)	35	47	56	62	62	62	56	48	71-4-1.5	57	73	80	86	86	86	82	74
56-4-2	52	64	73	79	79	79	73	65	71-8-1.5 (2V)	41	57	64	70	70	70	66	58
56-6-0.75	45	55	65	69	70	68	61	53	71-4-2	56	72	79	85	85	85	81	73

Acoustic characteristics

Sound power spectrum Lw(A) in dB(A) per Hz frequency band
Values measured at inlet with maximum flow rate

	63	125	250	500	1000	2000	4000	8000		63	125	250	500	1000	2000	4000	8000
71-8-2 (2V)	41	57	64	70	70	70	66	58	100-12-4 (2V)	41	56	66	69	70	67	59	51
71-4-3	56	72	79	85	85	85	81	73	100-6-5.5	57	72	82	85	86	83	75	67
71-8-3 (2V)	41	57	64	70	70	70	66	58	100-6/9-5.5	57	72	82	85	86	83	75	67
71-4-4	63	75	79	85	85	86	83	75	100-6/9-7.5	58	73	83	86	87	84	76	68
71-8-4 (2V)	48	60	64	70	70	71	68	60	100-6/9-10	61	76	86	89	90	87	79	71
71-6-0.75	46	53	73	76	76	71	63	55	125-4/6-20	69	85	96	103	104	102	95	87
71-12-0.75 (2V)	30	37	57	60	60	55	47	39	125-8/6-20 (2V)	54	70	81	88	89	87	80	72
71-6-1	46	64	73	76	76	71	64	55	125-4/6-25	68	84	95	102	103	101	94	86
71-12-1 (2V)	30	48	57	60	60	55	48	39	125-4/6-27	67	83	94	101	102	100	93	85
71-6-1.5	47	65	74	77	77	72	65	56	125-8/6-27 (2V)	52	68	79	86	87	85	78	70
71-12-1.5 (2V)	31	49	58	61	61	56	49	40	125-4/6-30	67	83	94	101	102	100	93	85
80-4-3	55	71	84	91	91	88	82	74	125-4/6-37	67	83	94	101	102	100	93	85
80-8-3 (2V)	40	56	69	76	76	73	67	59	125-8/6-37 (2V)	52	68	79	86	87	85	78	70
80-4-4	54	70	83	90	90	87	81	73	125-4/6-40	67	83	94	101	102	100	93	85
80-8-4 (2V)	39	55	68	75	75	72	66	58	125-4/6-50	67	83	94	101	102	100	93	85
80-4-5.5	53	69	82	89	89	86	80	72	125-4/6-60	67	83	94	101	102	100	93	85
80-8-5.5 (2V)	38	54	67	74	74	71	65	57	125-4/6-75	70	86	97	104	105	103	96	88
80-6-1.5	53	68	75	78	79	76	70	62	125-4/9-25	67	81	94	102	104	101	96	88
80-12-1.5 (2V)	37	52	59	62	63	60	54	46	125-4/9-27	66	80	93	101	103	100	95	87
80-6-2	59	69	75	79	80	78	73	65	125-8/9-27 (2V)	51	65	78	86	88	85	80	72
80-12-2 (2V)	43	53	59	63	64	62	57	49	125-4/9-30	66	80	93	101	103	100	95	87
80-6-3	60	70	76	80	81	79	74	66	125-4/9-37	65	79	92	100	102	99	94	86
80-12-3 (2V)	45	55	61	65	66	64	59	51	125-8/9-37 (2V)	50	64	77	85	87	84	79	71
80-8-0.75	46	59	67	72	74	71	64	53	125-4/9-40	65	79	92	100	102	99	94	86
80-8-1	47	60	68	73	75	72	65	54	125-4/9-50	65	79	92	100	102	99	94	86
90-4-4	61	77	88	94	95	93	88	80	125-4/9-60	73	86	95	99	101	100	96	89
90-8-4 (2V)	46	62	73	79	80	78	73	65	125-4/9-75	74	87	96	100	102	101	97	90
90-4-5.5	60	76	87	93	94	92	87	79	125-4/9-100	76	89	98	102	104	103	99	92
90-8-5.5 (2V)	45	61	72	78	79	77	72	64	125-4/12-50	66	80	93	101	103	100	95	87
90-4-7.5	59	75	86	92	93	91	86	78	125-4/12-60	66	80	93	101	103	100	95	87
90-8-7.5 (2V)	44	60	71	77	78	76	71	63	125-4/12-75	74	87	96	100	102	101	97	90
90-4-10	58	74	85	91	92	90	85	77	125-4/12-100	76	89	98	102	104	103	99	92
90-8-10 (2V)	43	59	70	76	77	75	70	62	125-6/6-5.5	64	79	89	92	93	90	85	77
90-6-2	52	67	78	82	82	78	71	63	125-6/6-7.5	62	77	87	90	91	88	83	75
90-12-2 (2V)	36	51	62	66	66	62	55	47	125-12/6-7.5 (2V)	47	62	72	75	76	73	68	60
90-6-3	52	67	78	82	82	78	71	63	125-6/6-10	61	76	86	89	90	87	82	74
90-12-3 (2V)	37	52	63	67	67	63	56	48	125-12/6-10 (2V)	46	61	71	74	75	72	67	59
90-6-4	60	70	80	85	85	82	76	68	125-6/6-15	61	76	86	89	90	87	82	74
90-12-4 (2V)	45	55	65	70	70	67	61	53	125-12/6-15 (2V)	46	61	71	74	75	72	67	59
90-8-1	42	63	70	75	78	74	67	56	125-6/6-20	63	78	88	91	92	89	84	76
90-8-2	51	66	73	78	81	77	70	59	125-6/6-24	65	80	90	93	94	91	86	78
90-8-3	53	67	74	79	82	78	71	60	125-12/6-24 (2V)	50	65	75	78	79	76	71	63
100-4-7.5	67	83	90	97	98	96	92	84	125-6/9-10	61	76	87	93	94	88	84	77
100-8-7.5 (2V)	52	68	75	82	83	81	77	69	125-12/9-10 (2V)	46	61	72	78	79	73	69	62
100-4-10	65	81	88	95	96	94	90	82	125-6/9-15	59	74	85	91	92	86	82	75
100-8-10 (2V)	50	66	73	80	81	79	75	67	125-12/9-15 (2V)	44	59	70	76	77	71	67	60
100-4-15	71	83	87	93	94	94	91	83	125-6/9-20	59	74	85	91	92	86	82	75
100-8-15 (2V)	56	68	72	78	79	79	76	68	125-6/9-24	60	75	86	92	93	87	83	76
100-4-20	72	84	88	94	95	95	92	84	125-12/9-24 (2V)	45	60	71	77	78	72	68	61
100-8-20 (2V)	57	69	73	79	80	80	77	69	125-6/9-25	61	76	87	93	94	88	84	77
100-4/9-15	65	81	88	95	96	94	90	82	125-6/9-30	64	79	90	96	97	91	87	80
100-4/9-20	72	84	88	94	95	95	92	84	125-6/12-10	63	78	89	95	96	90	86	79
100-4/9-25	72	84	88	94	95	95	92	84	125-6/12-15	61	76	87	93	94	88	84	77
100-4/9-30	74	86	90	96	97	97	94	86	125-6/12-20	60	75	86	92	93	87	83	76
100-6-3	57	72	82	85	86	83	75	67	125-6/12-25	61	76	87	93	94	88	84	77
100-12-3 (2V)	42	57	67	70	71	68	60	52	125-6/12-30	62	77	88	94	95	89	85	78
100-6-4	56	71	81	84	85	82	74	66	125-6/12-40	63	78	89	95	96	90	86	79

Dimensions mm

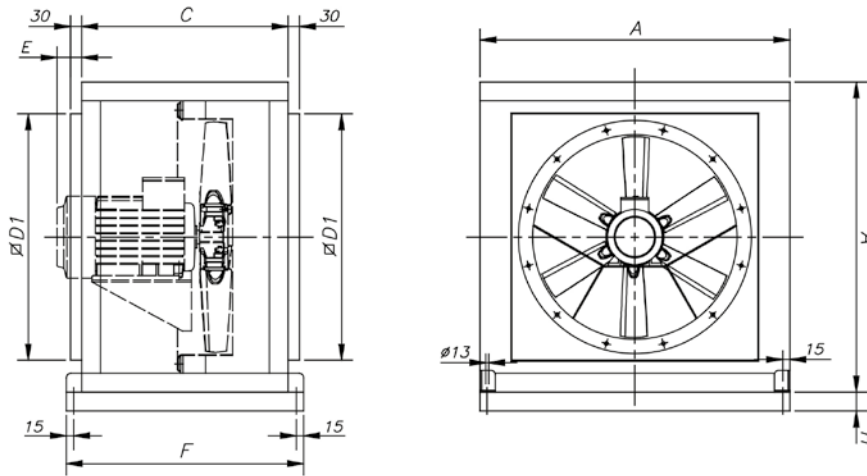

	A	C	ØD1	E	F	H
CJTHT/ATEX-40/45/50	700	550	565	-	630	-
CJTHT/ATEX-56/63	825	550	690	140	630	-
CJTHT/ATEX-71/80	1000	650	850	-	730	-
CJTHT/ATEX-90/100	1200	750	1050	-	830	-
CJTHT/ATEX-125 ≤20 HP	1600	1200	1400	-	1280	-
CJTHT/ATEX-125 >20 HP	1600	1200	1400	123	1280	100

Accessories



INT/ATEX



IAT



CABLE BOX



C2V



VSD3/A-RFT
- VSD1/A-RFM



CENTRAL CO



AET



P-400

EXAMPLE OF SELECTION

Characteristic curves

Q= Flow rate in m³/h, m³/s and cfm

Pe= Static pressure in mm H₂O, Pa and inwg

Impeller diameter in cm: 71

Number of motor poles: 6

Number of blades: 6

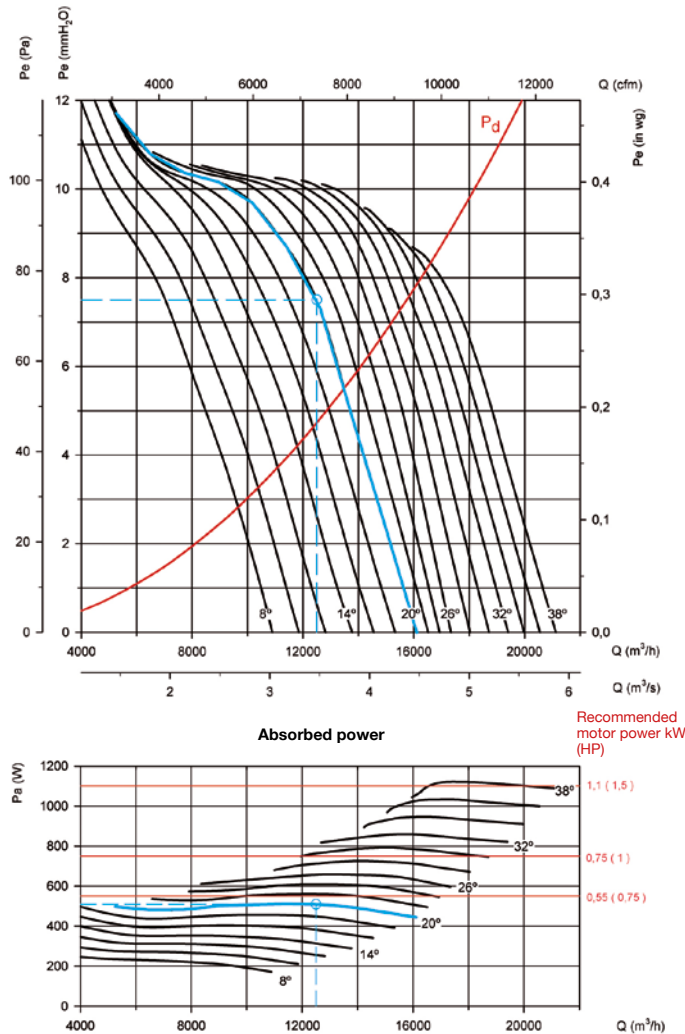

Initial data

Working point:

- Flow rate: 12,500 m³/h
- Loss of load: 7.5 mmH₂O

Steps for the selection of equipment

On the pressure graph:

- Mark the working point, defined by the airflow (12,500 m³/h) and the loss of load (7.5 mmH₂O).
- Select the curve of the equipment which is closest above the working point. In our case, a curve with a blade angle of 20° is obtained.

On the power graph:

- Mark the working point, defined by the airflow (12,500 m³/h) and the selected blade angle (20°).
- Read the absorbed power on the power axis on the left. Pa= 510 W at the working point.
- Look for the straight red line which is closest to the working point above. On the right-hand side of the graph, the value of the installed motor power is obtained. In our case, this is 0.55 kW or 0.75 HP.

EXAMPLE OF ORDER CODE

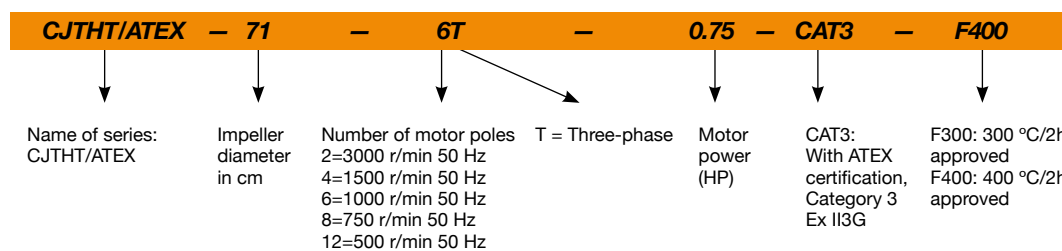

Characteristic curves

Q= Flow rate in m³/h, m³/s and cfm

Pe= Static pressure in mm H₂O, Pa and inwg

Impeller diameter in cm: 40

Number of motor poles: 2

Number of blades: 6

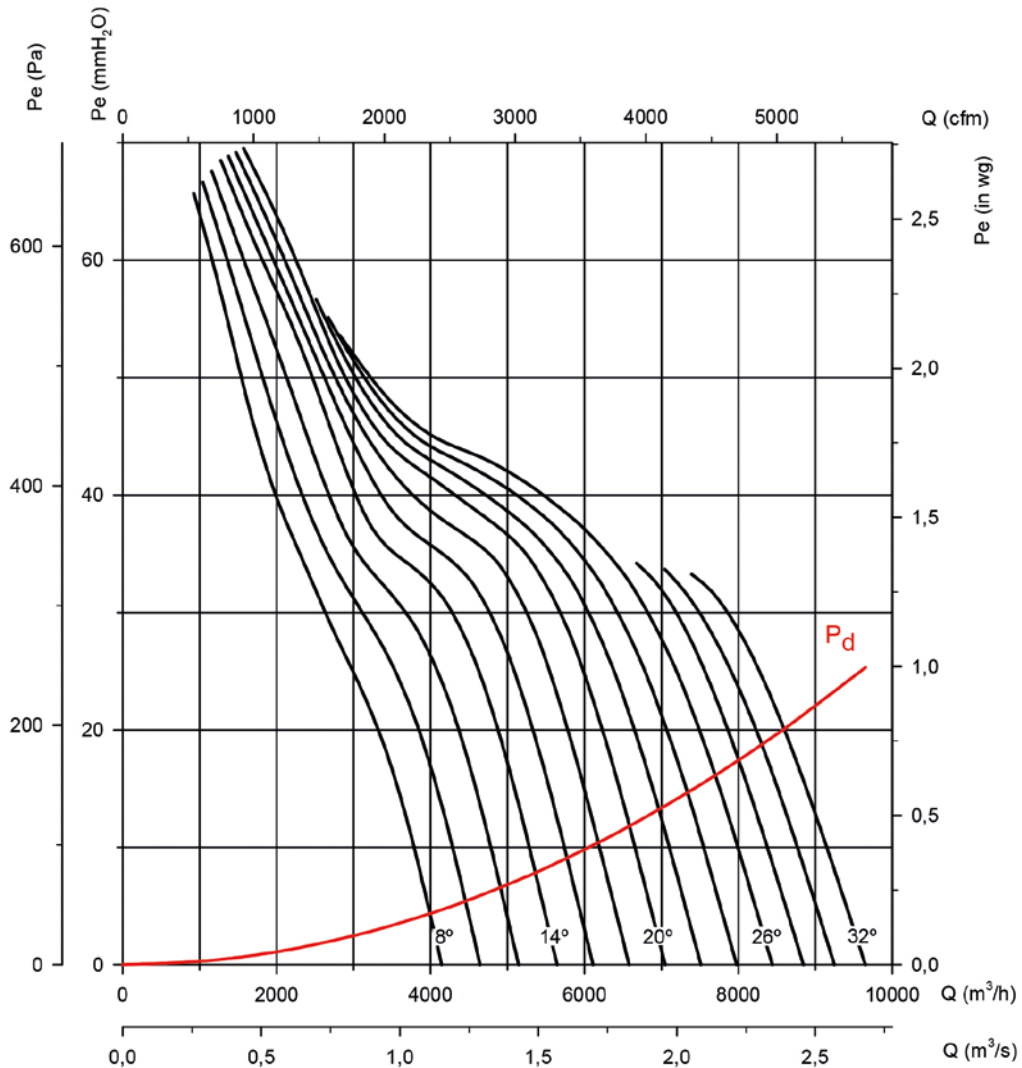

Absorbed power

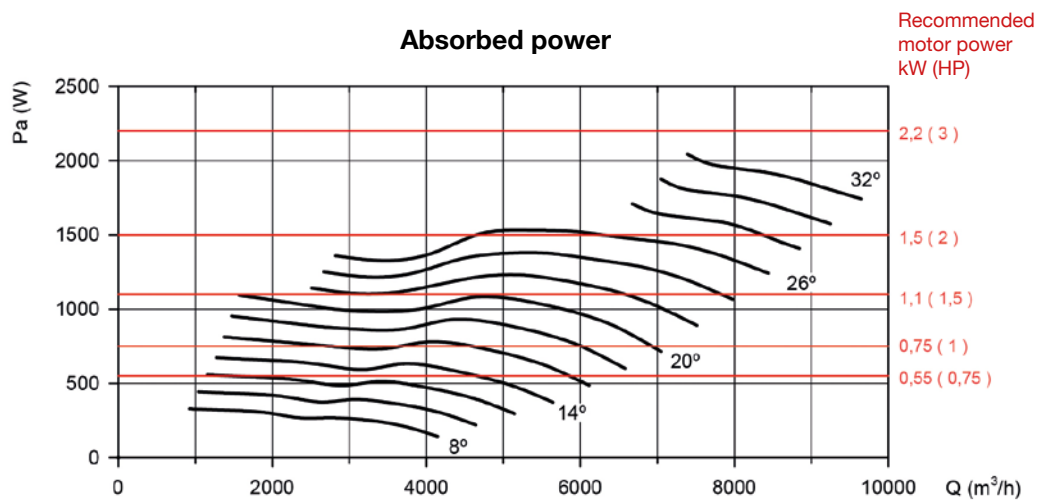

Characteristic curves

Q= Flow rate in m³/h, m³/s and cfm

Pe= Static pressure in mm H₂O, Pa and inwg

Impeller diameter in cm: 40

Number of motor poles: 4

Number of blades: 6

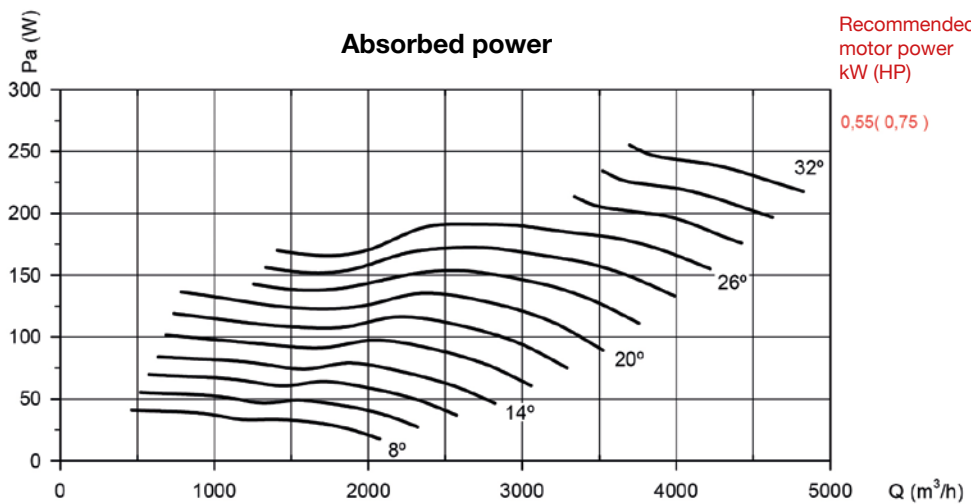
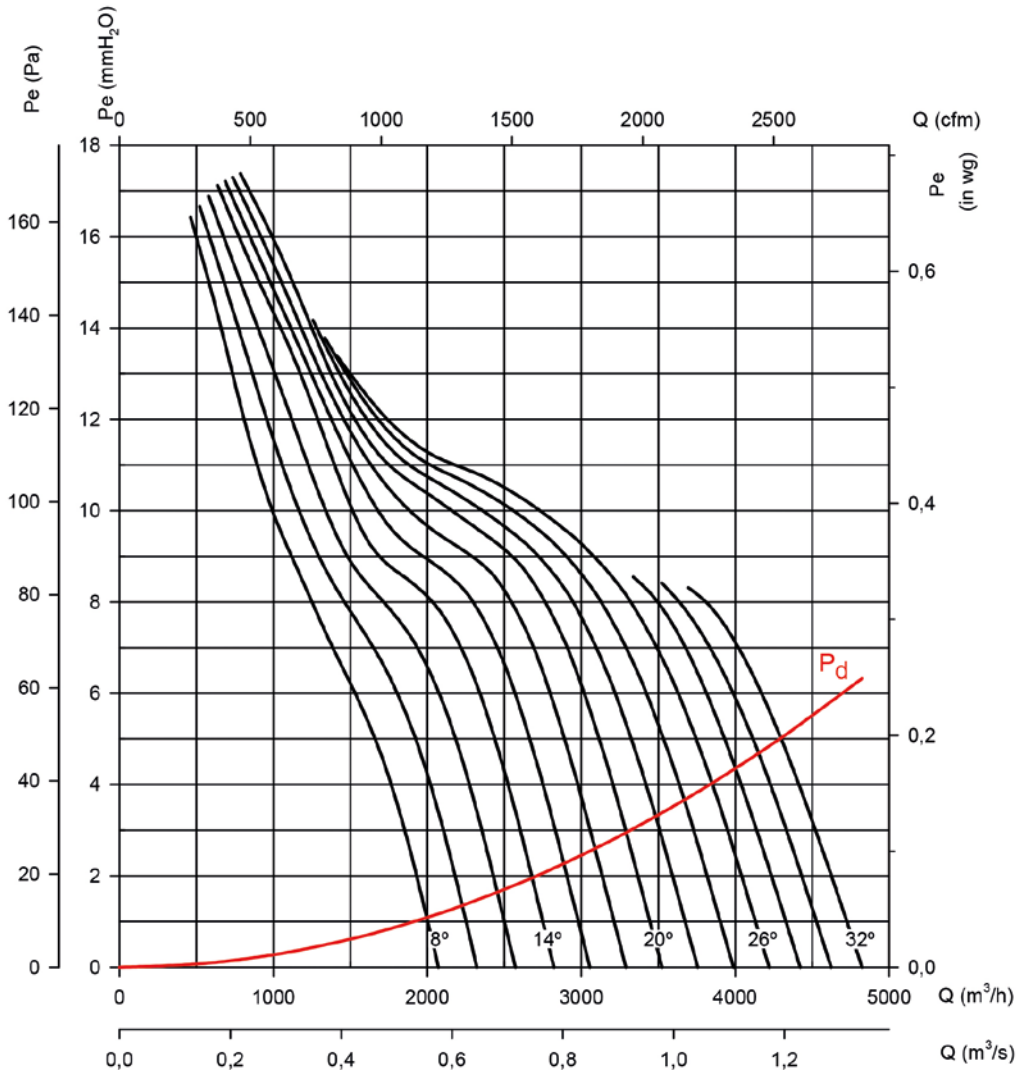

Characteristic curves

Q= Flow rate in m³/h, m³/s and cfm Pe= Static pressure in mm H₂O, Pa and inwg

Impeller diameter in cm: 40

Number of motor poles: 6

Number of blades: 6

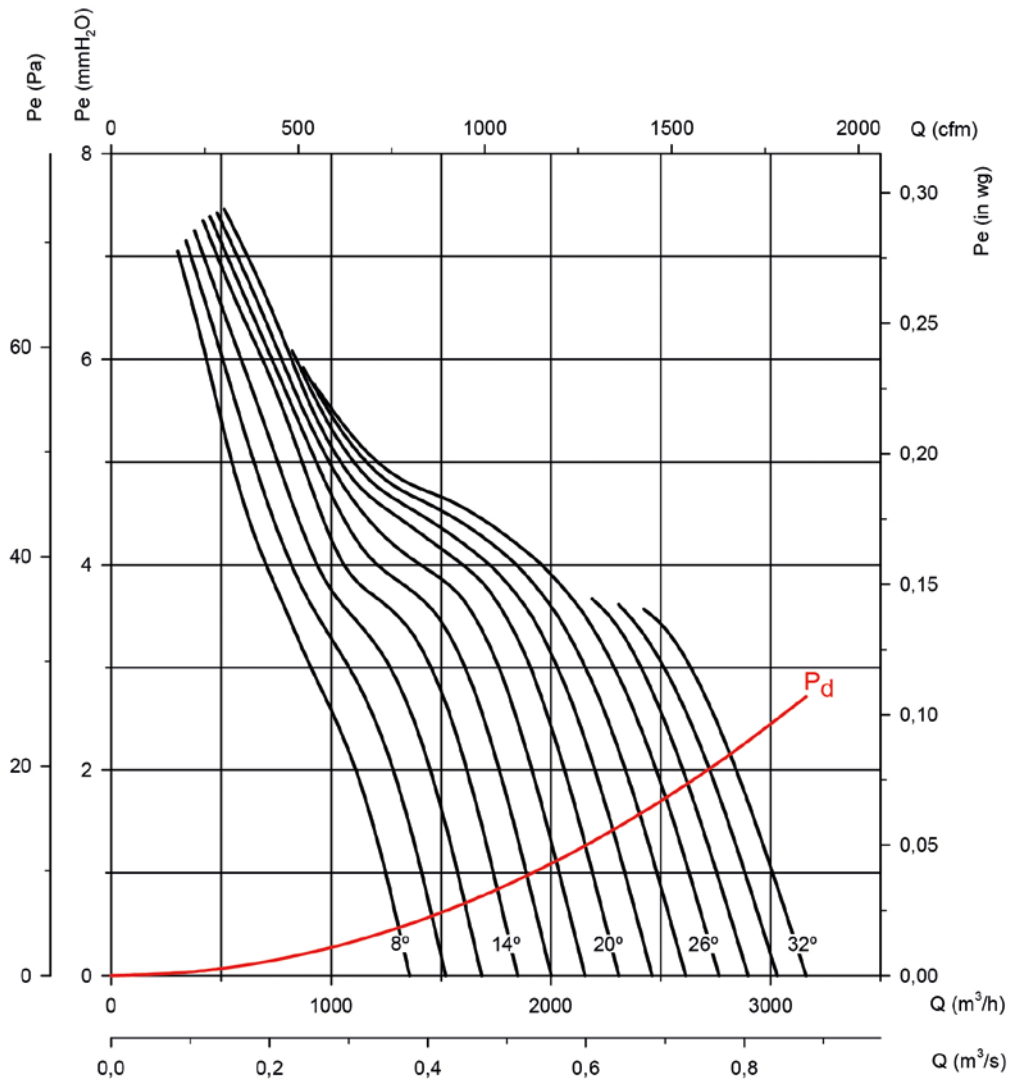

Absorbed power

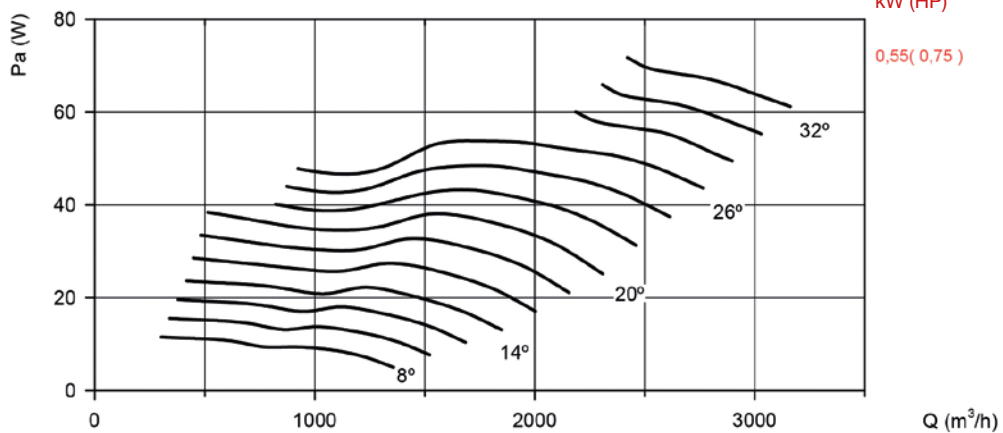

Characteristic curves

Q= Flow rate in m³/h, m³/s and cfm Pe= Static pressure in mm H₂O, Pa and inwg

Impeller diameter in cm: 45

Number of motor poles: 2

Number of blades: 6

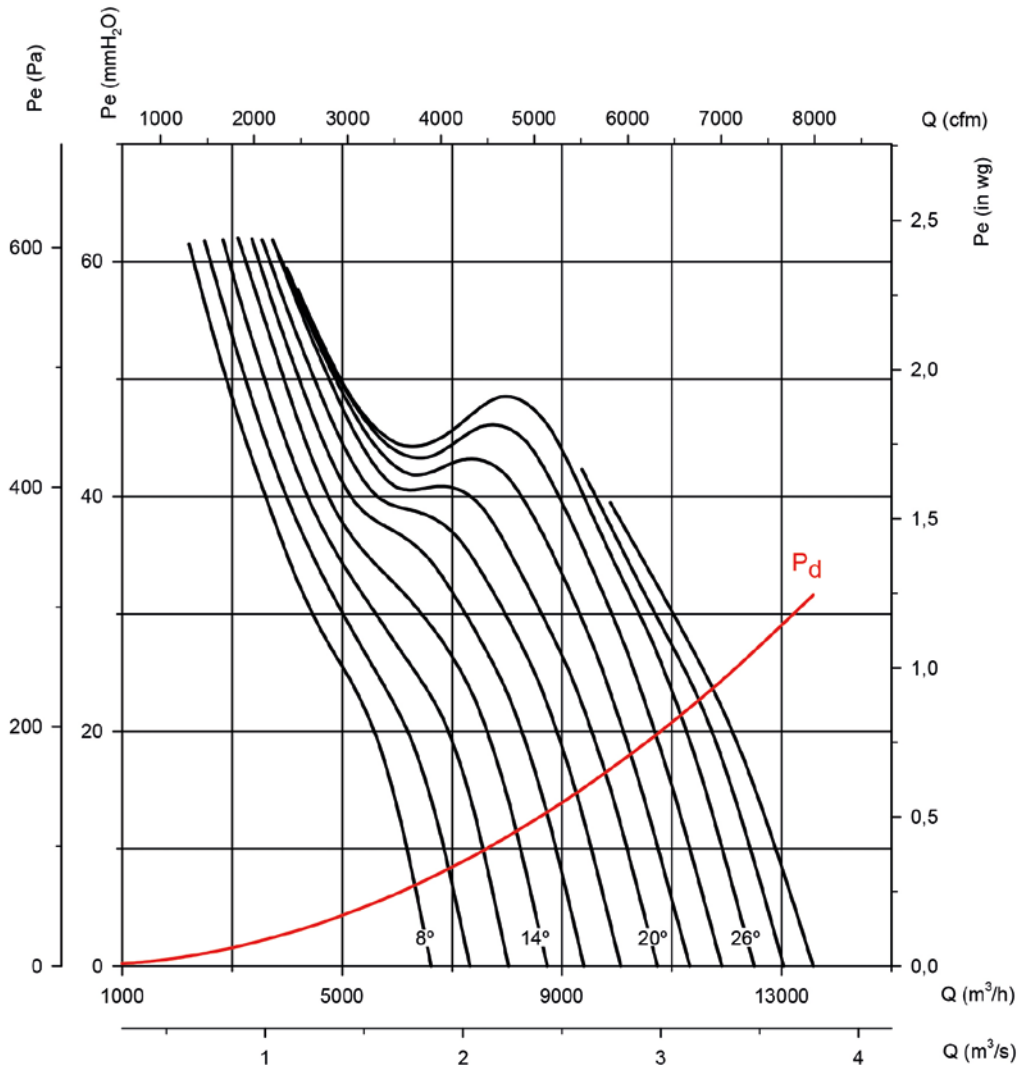

Absorbed power

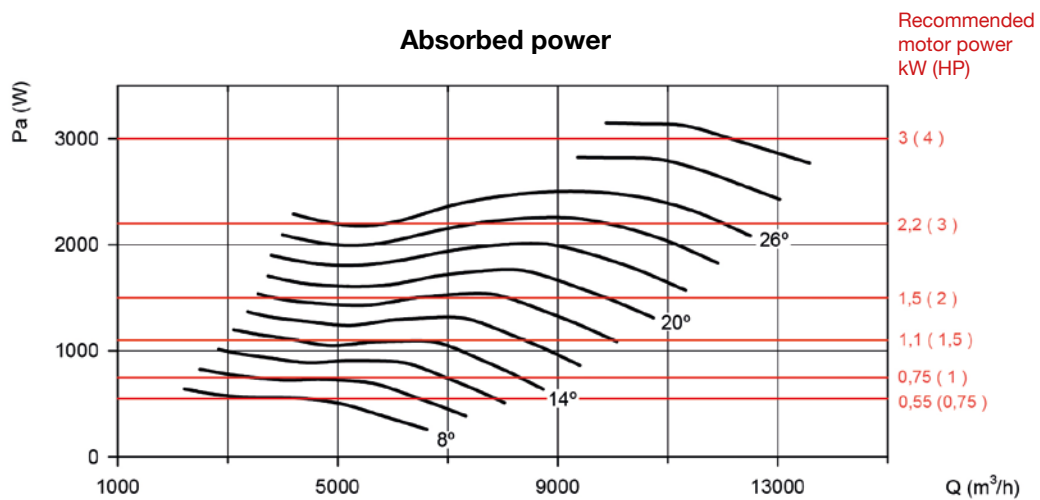

Characteristic curves

Q= Flow rate in m³/h, m³/s and cfm Pe= Static pressure in mm H₂O, Pa and inwg

Impeller diameter in cm: 45

Number of motor poles: 4

Number of blades: 6

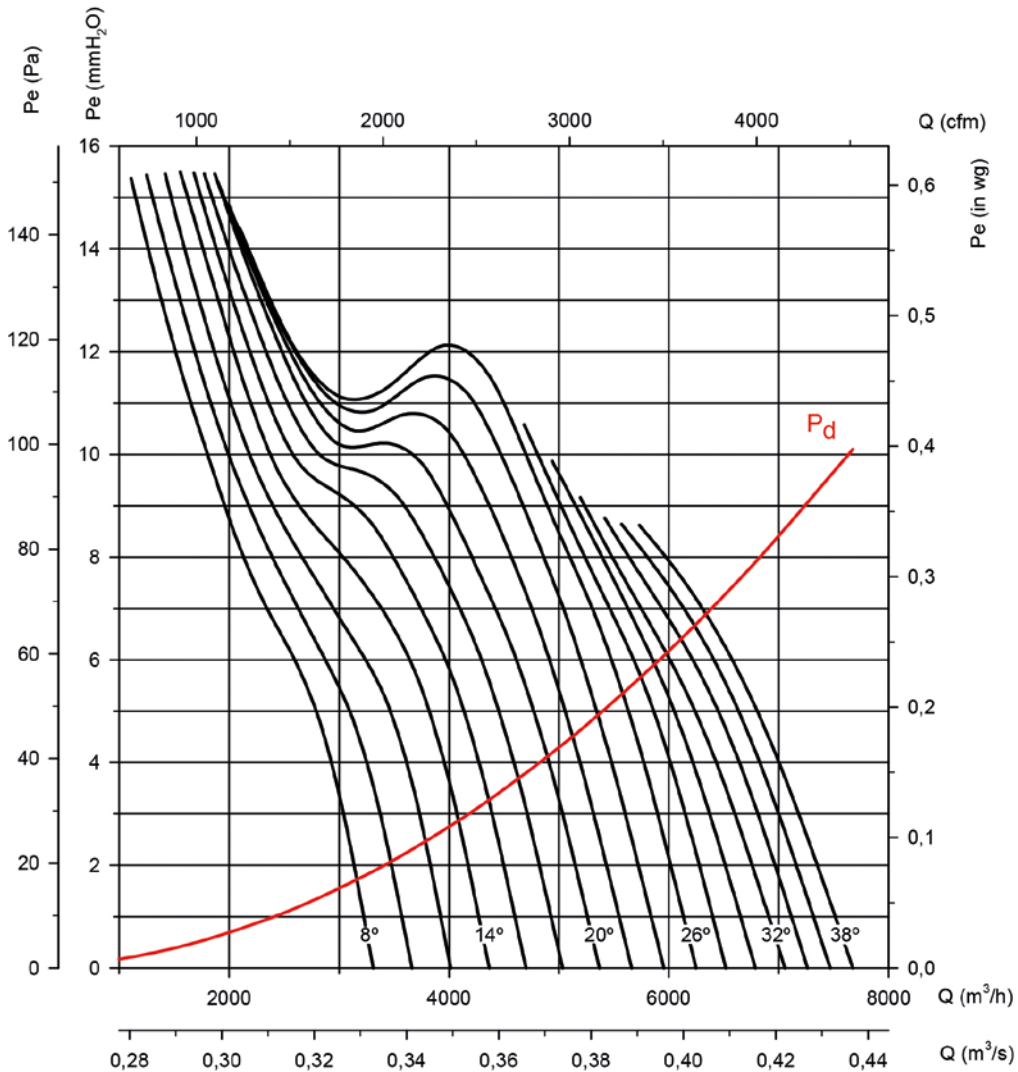

Absorbed power

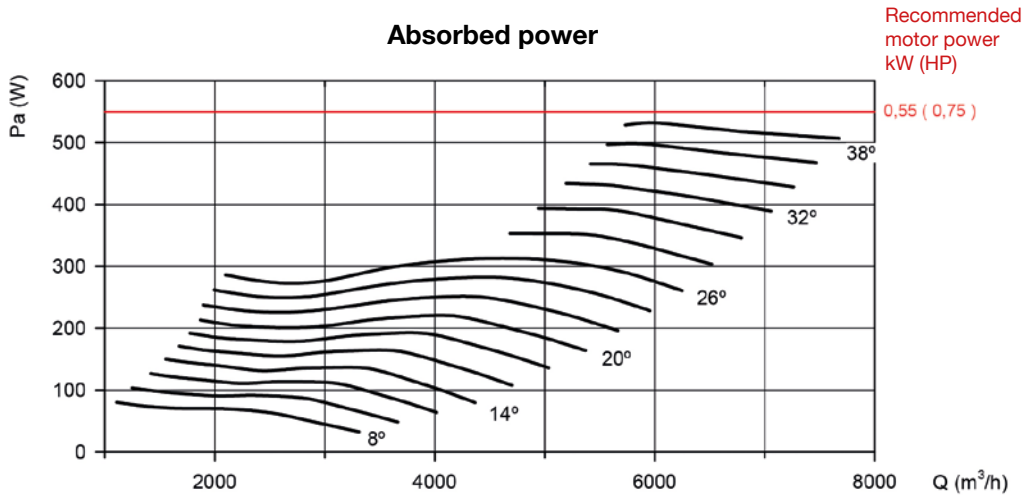

Characteristic curves

Q= Flow rate in m³/h, m³/s and cfm

Pe= Static pressure in mm H₂O, Pa and inwg

Impeller diameter in cm: 45

Number of motor poles: 6

Number of blades: 6

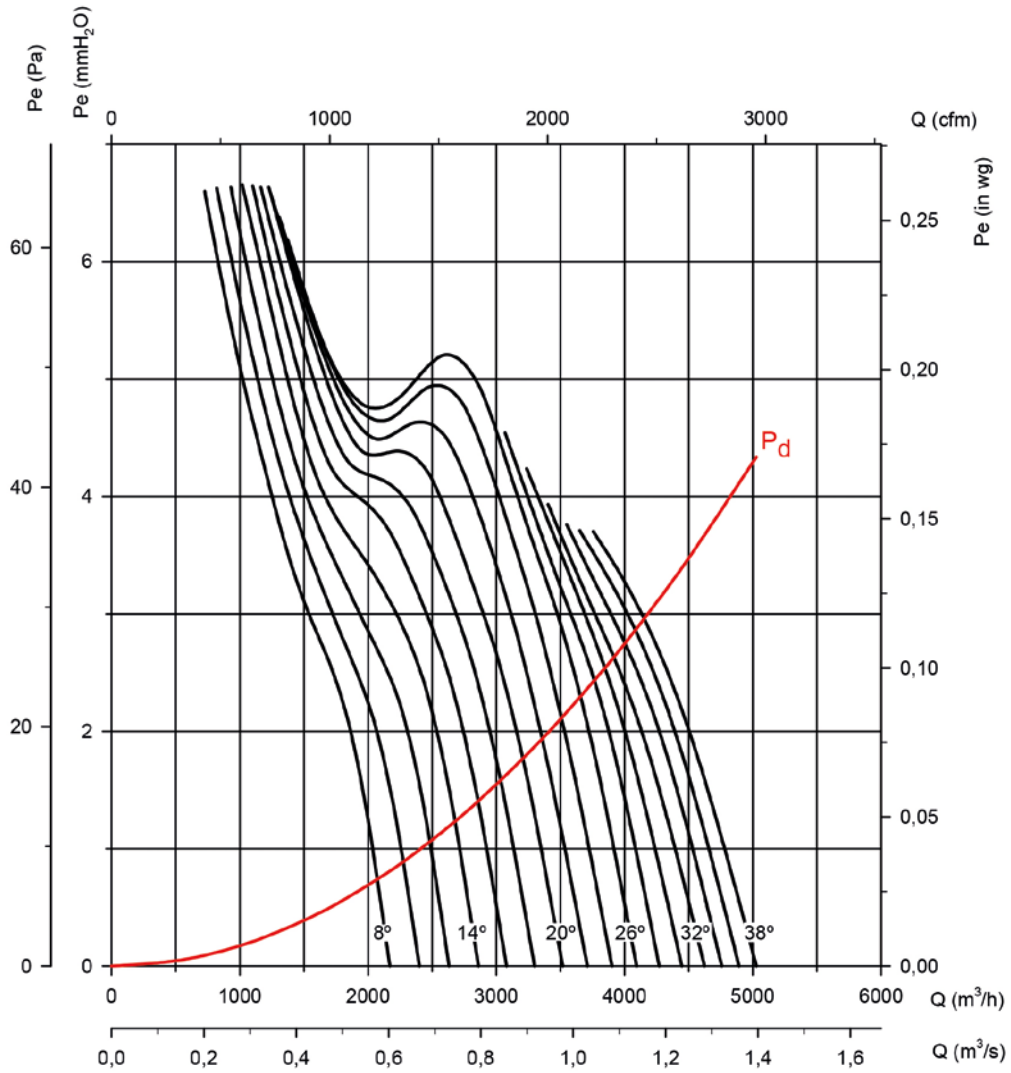

Absorbed power

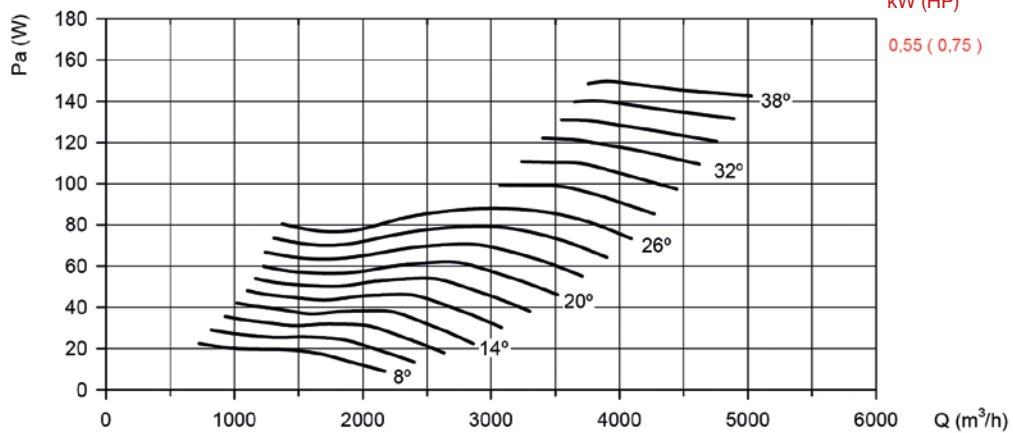

Characteristic curves

Q= Flow rate in m³/h, m³/s and cfm Pe= Static pressure in mm H₂O, Pa and inwg

Impeller diameter in cm: 50

Number of motor poles: 4

Number of blades: 6

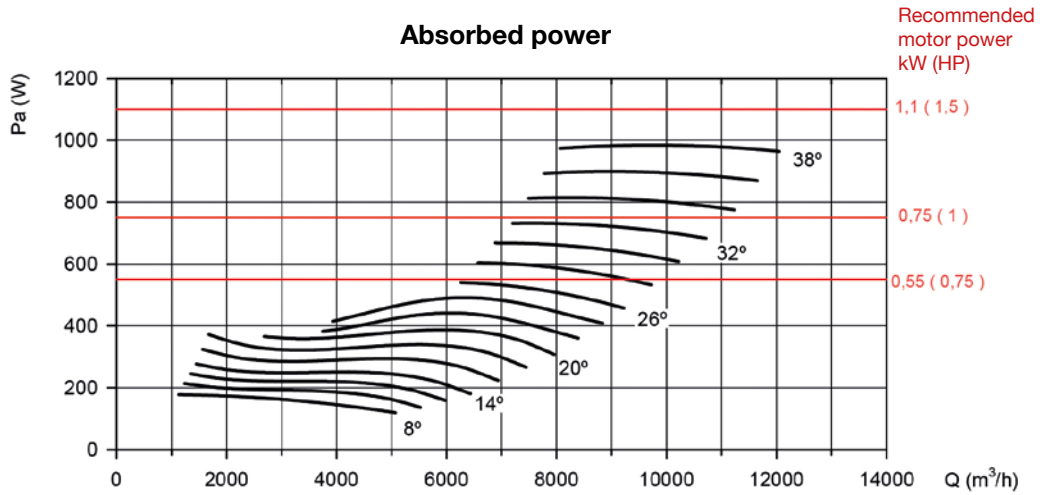
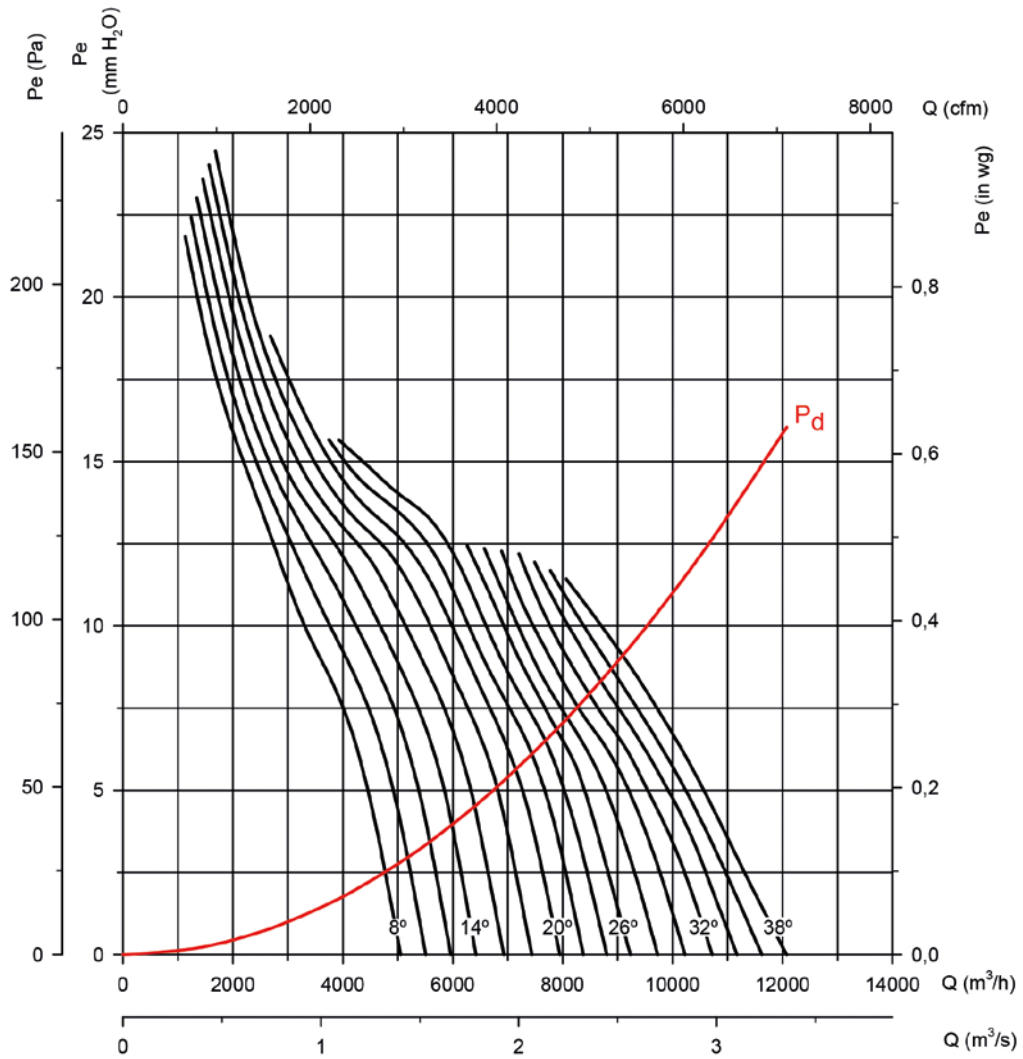

Characteristic curves

Q= Flow rate in m³/h, m³/s and cfm

Pe= Static pressure in mm H₂O, Pa and inwg

Impeller diameter in cm: 50

Number of motor poles: 6

Number of blades: 6

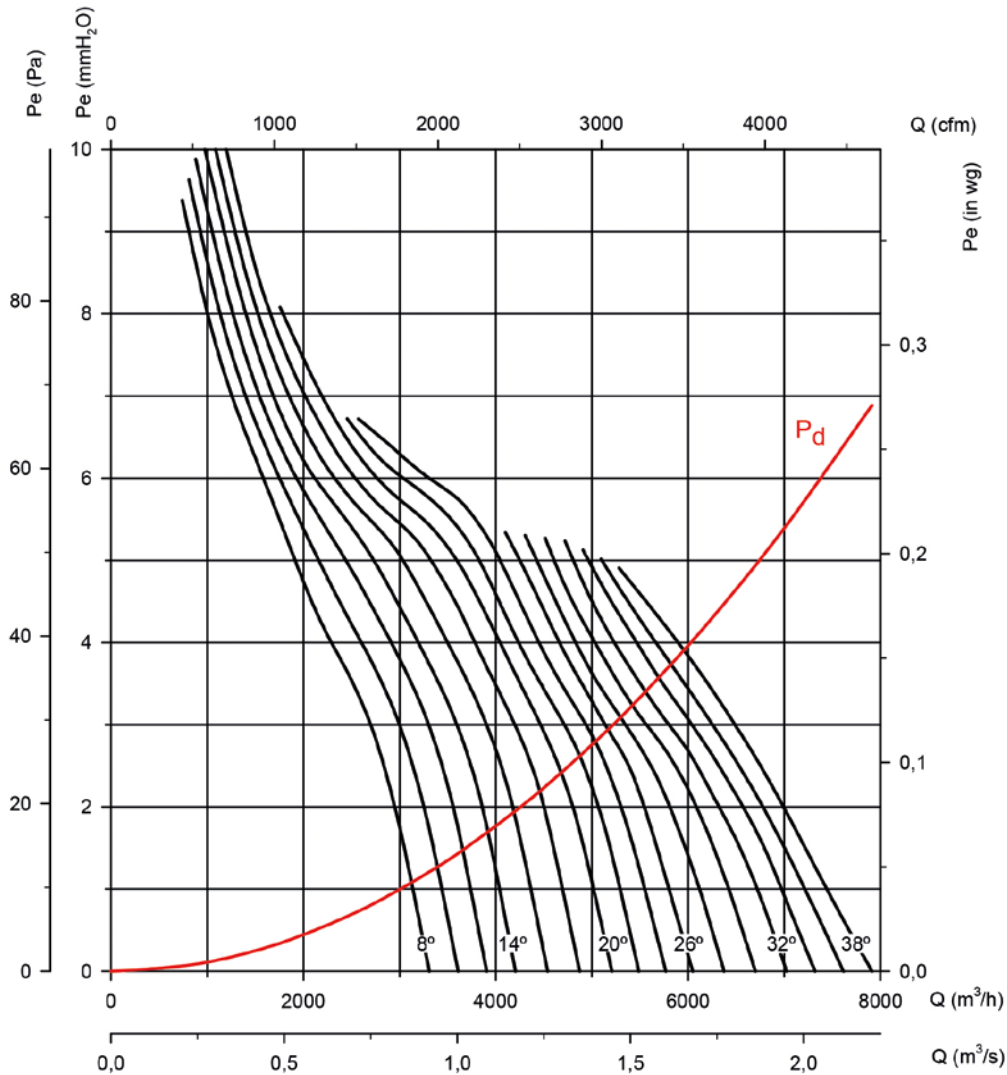

Absorbed power

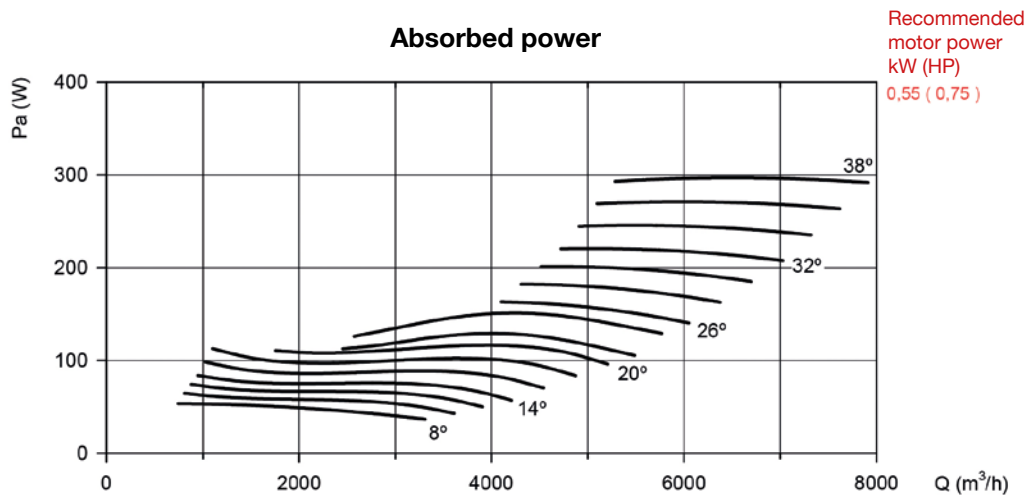

Characteristic curves

Q= Flow rate in m³/h, m³/s and cfm Pe= Static pressure in mm H₂O, Pa and inwg

Impeller diameter in cm: 56

Number of motor poles: 4

Number of blades: 6

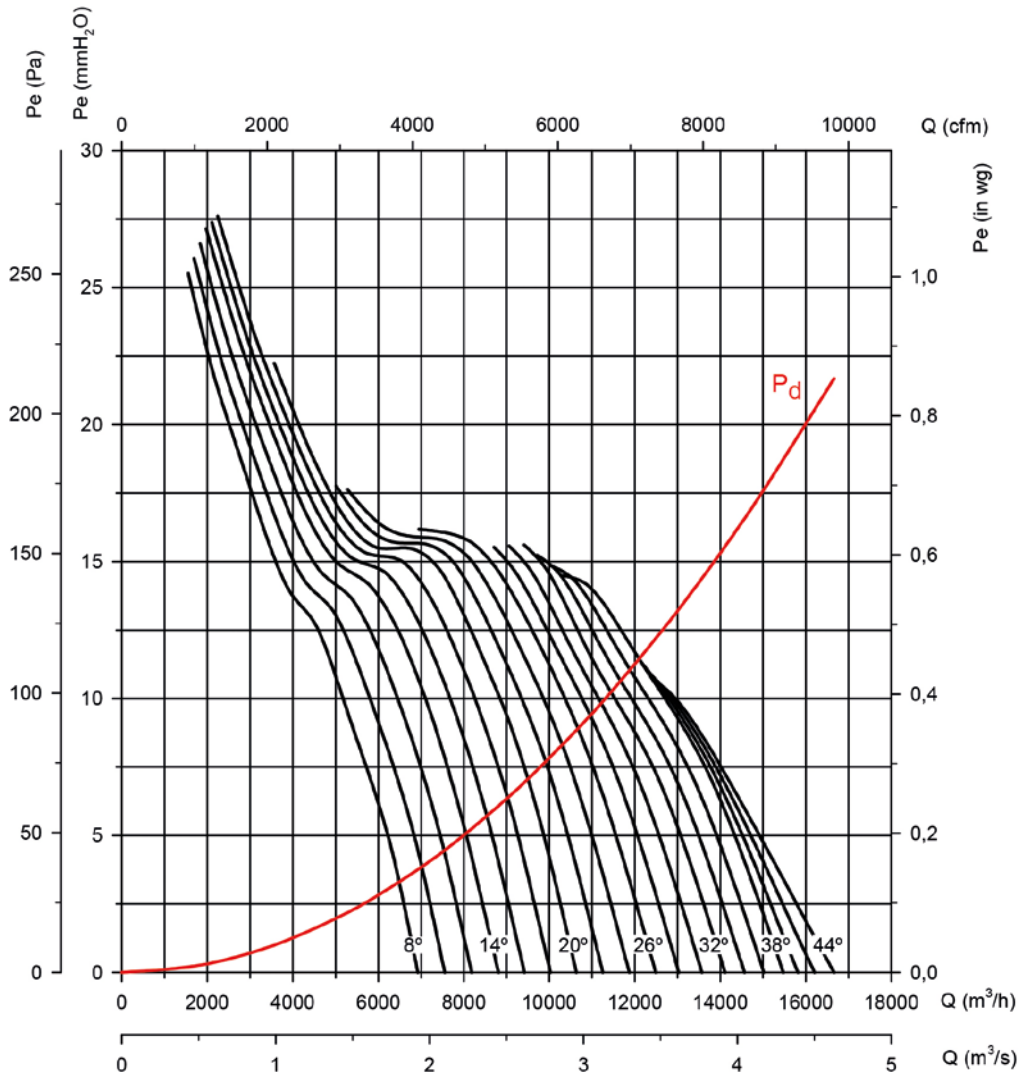

Absorbed power

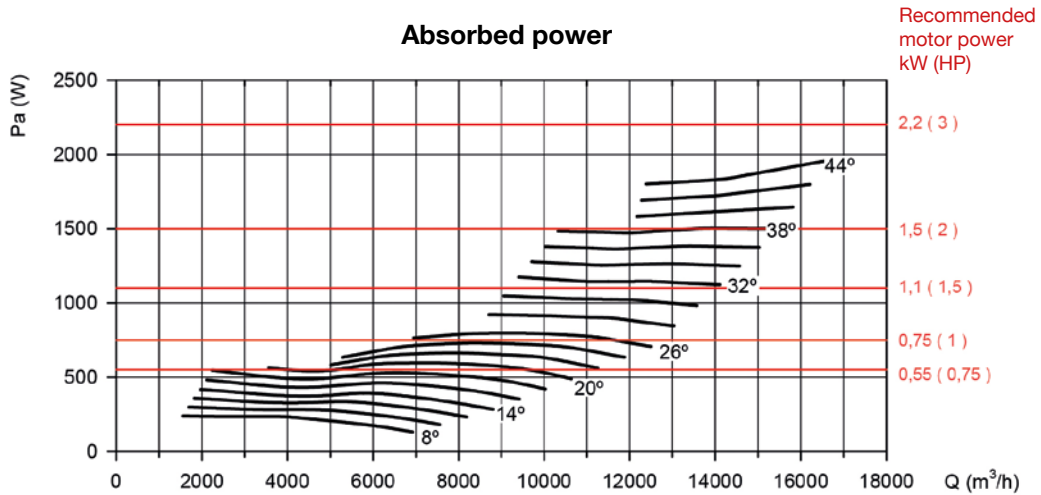

Characteristic curves

Q= Flow rate in m³/h, m³/s and cfm

Pe= Static pressure in mm H₂O, Pa and inwg

Impeller diameter in cm: 56

Number of motor poles: 6

Number of blades: 6

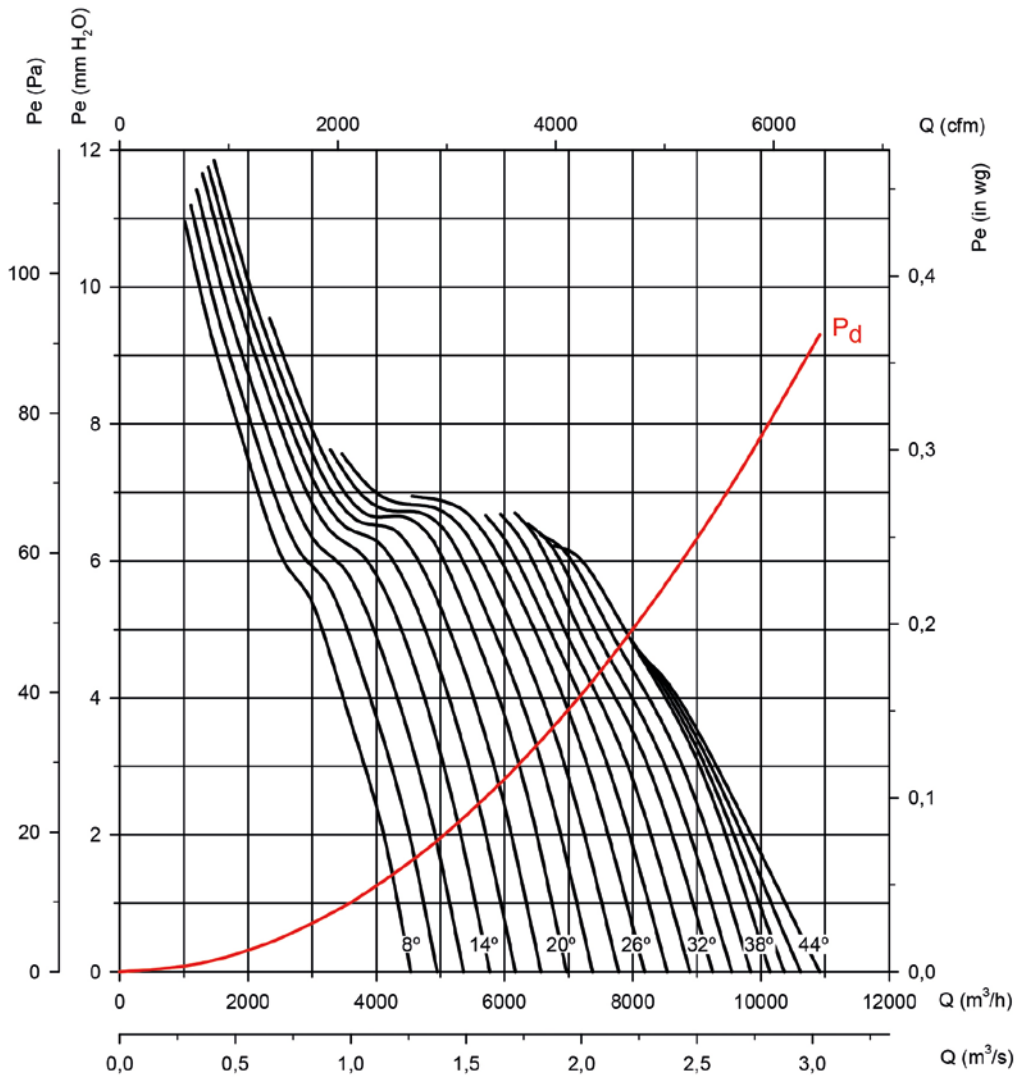

Absorbed power

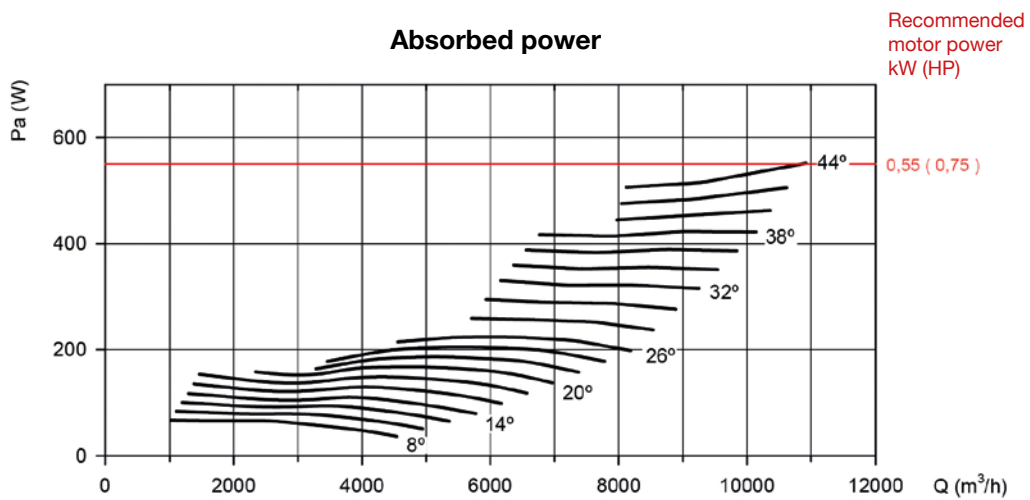

Characteristic curves

Q= Flow rate in m³/h, m³/s and cfm

Pe= Static pressure in mm H₂O, Pa and inwg

Impeller diameter in cm: 63

Number of motor poles: 4

Number of blades: 6

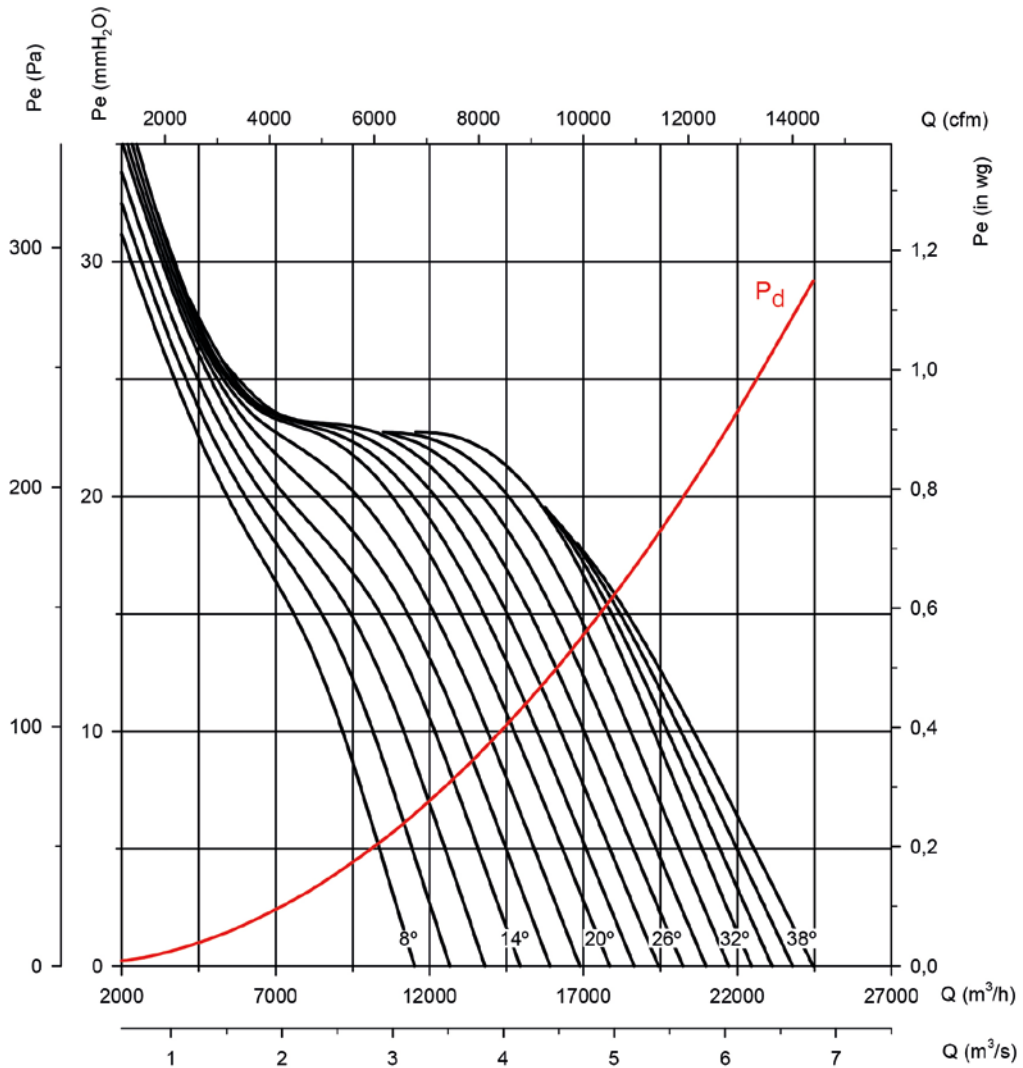

Absorbed power

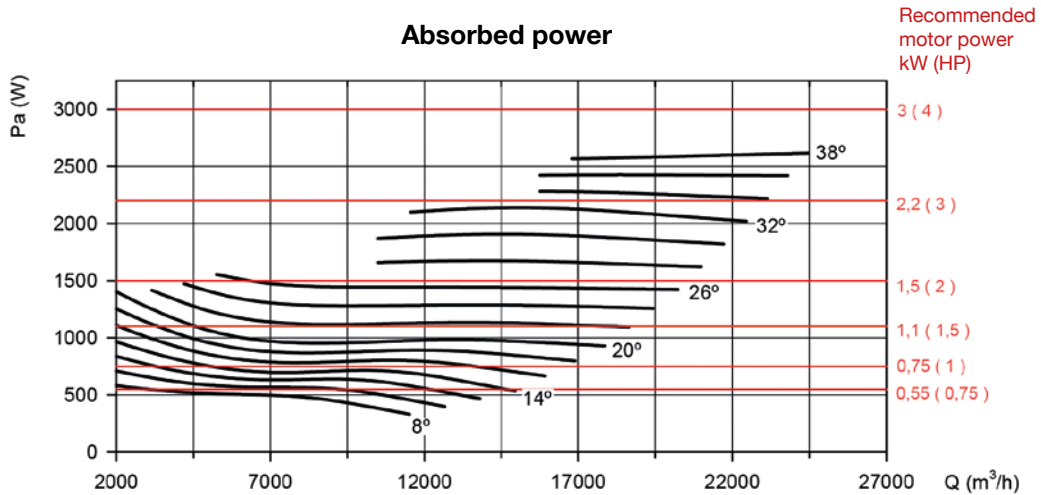

Characteristic curves

Q= Flow rate in m³/h, m³/s and cfm

Pe= Static pressure in mm H₂O, Pa and inwg

Impeller diameter in cm: 63

Number of motor poles: 6

Number of blades: 6

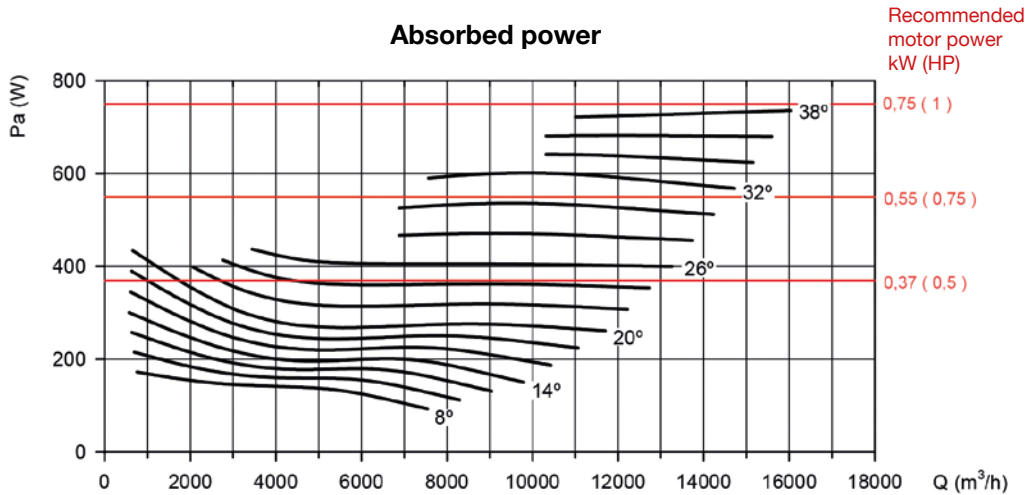
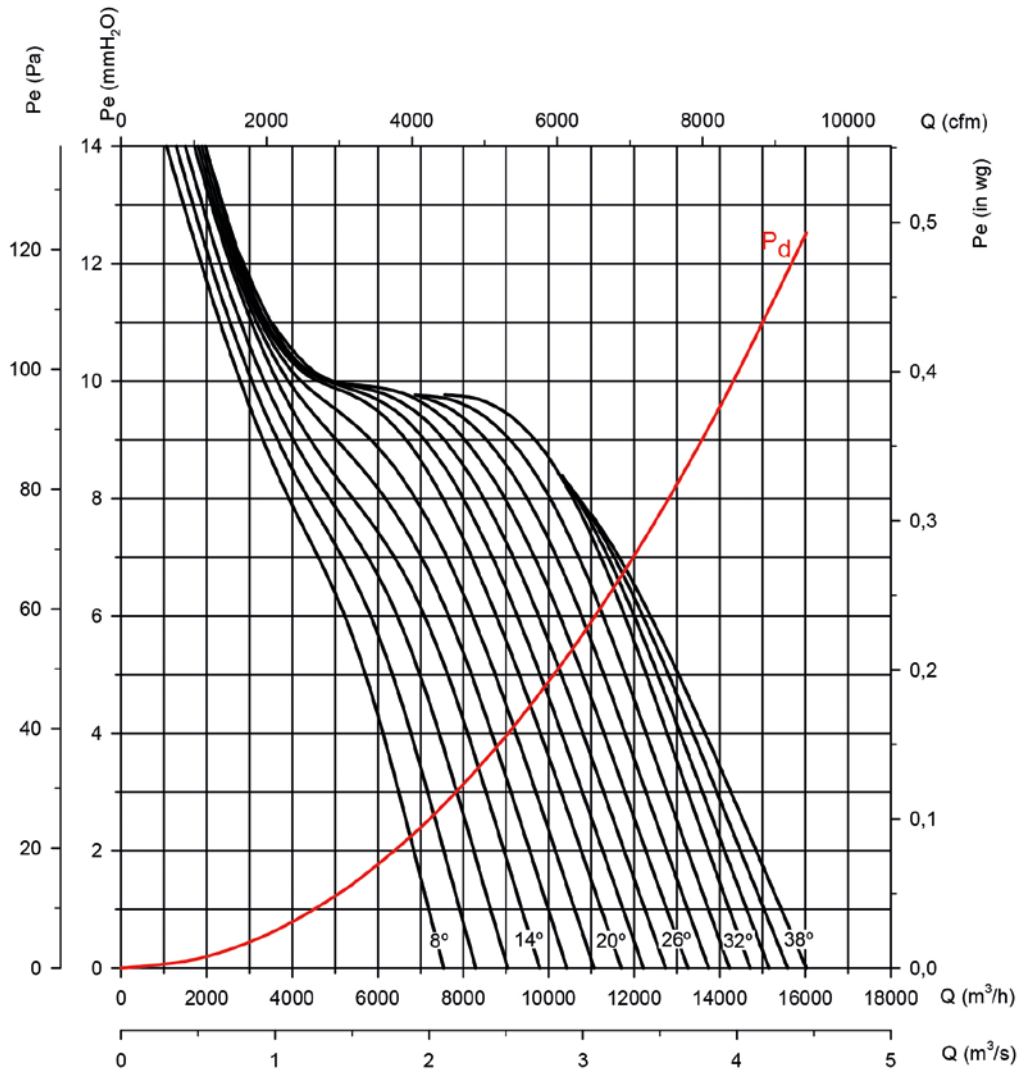

Characteristic curves

Q= Flow rate in m³/h, m³/s and cfm Pe= Static pressure in mm H₂O, Pa and inwg

Impeller diameter in cm: 71

Number of motor poles: 4

Number of blades: 6

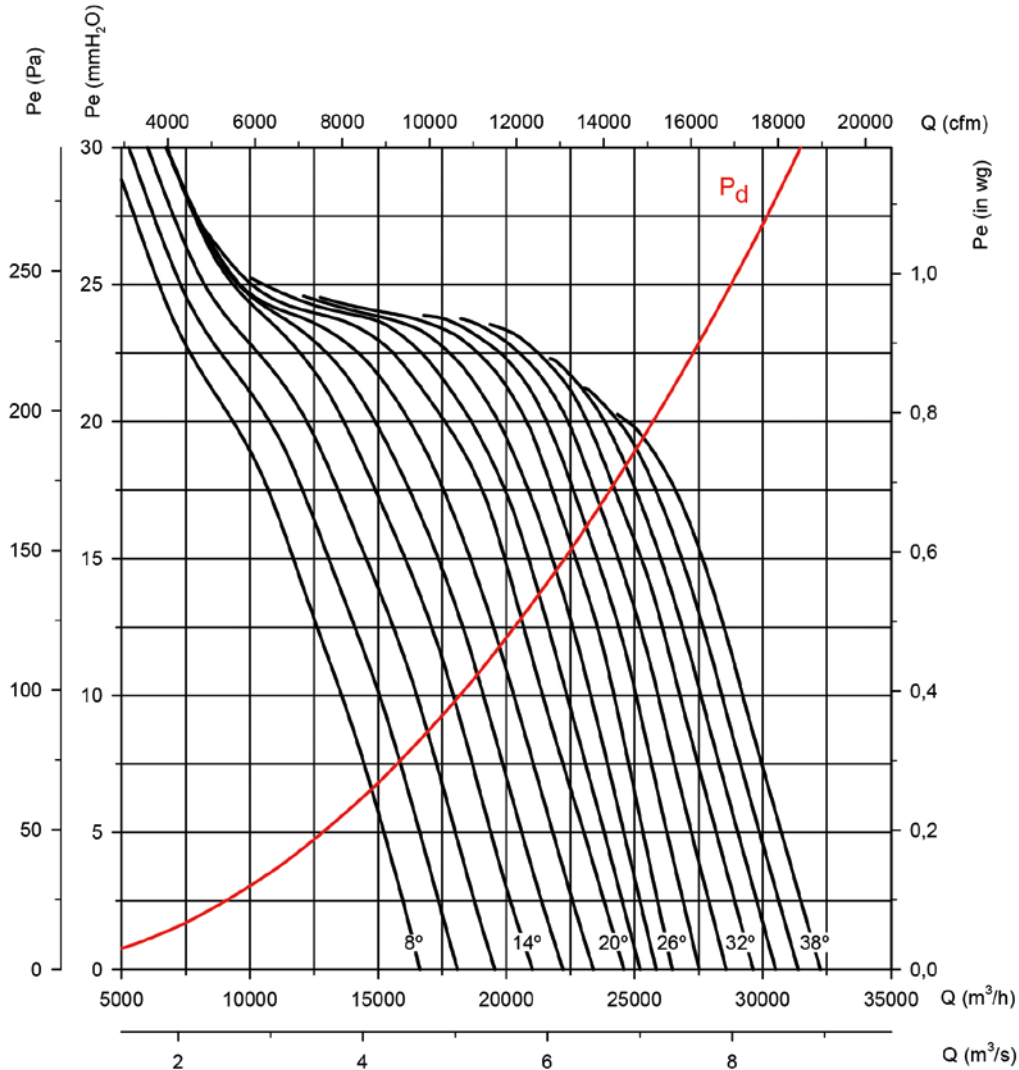

Absorbed power

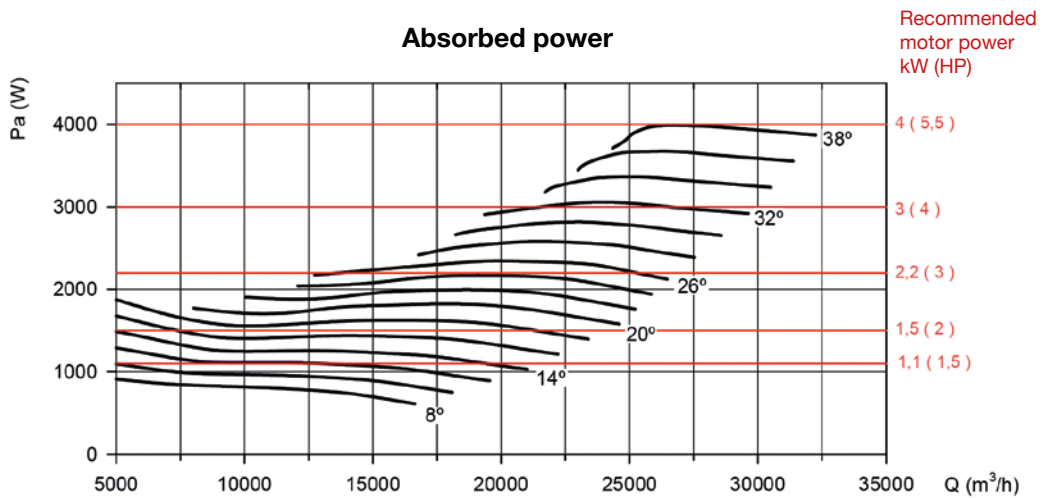

Characteristic curves

Q= Flow rate in m³/h, m³/s and cfm

Pe= Static pressure in mm H₂O, Pa and inwg

Impeller diameter in cm: 71

Number of motor poles: 6

Number of blades: 6

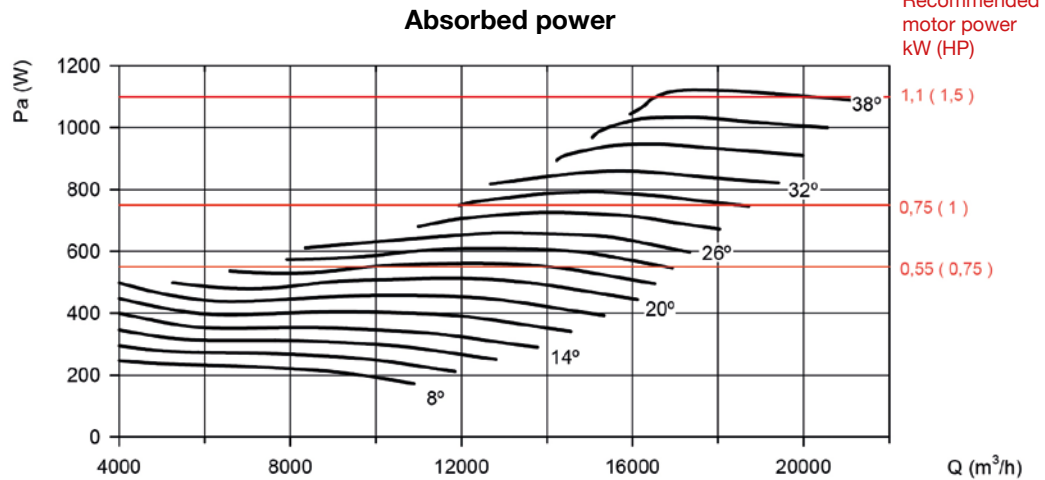
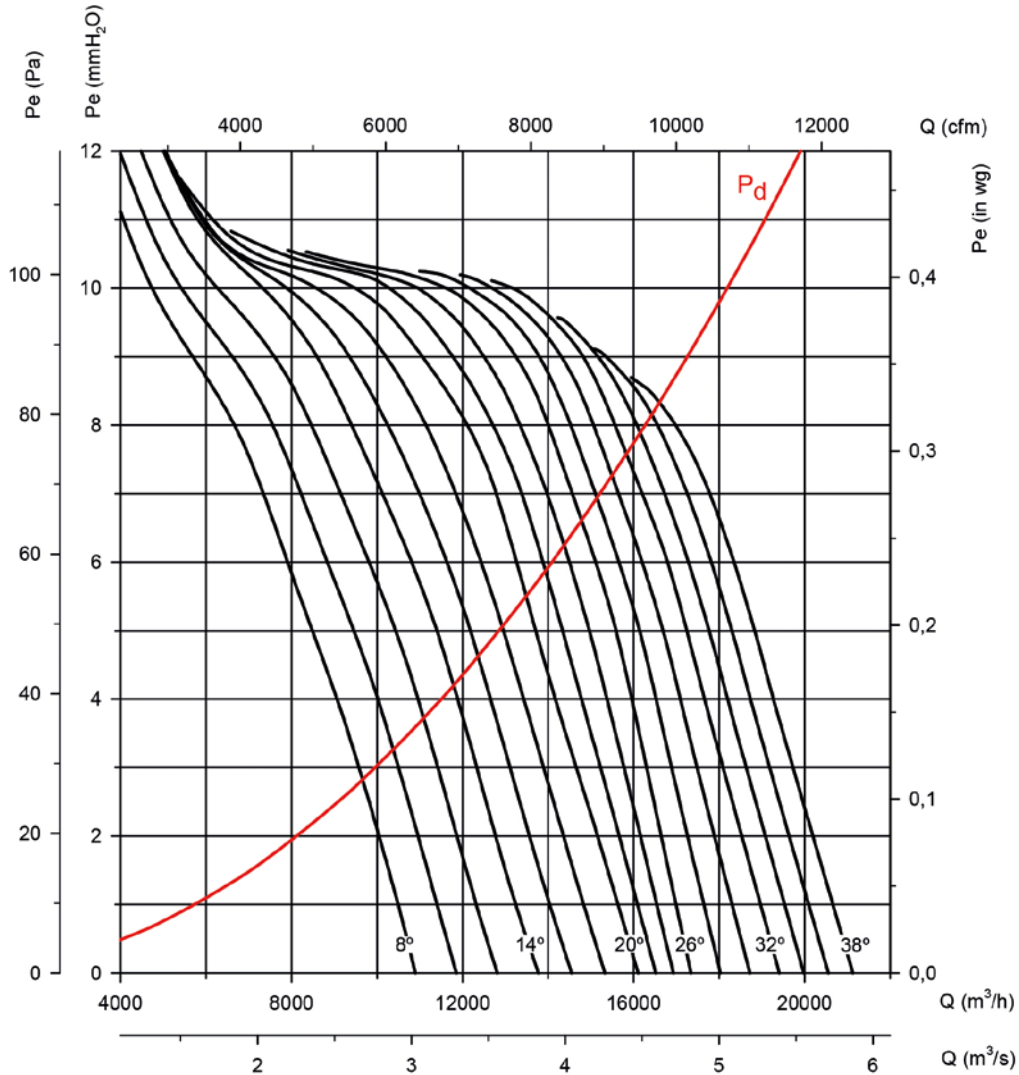

Characteristic curves

Q= Flow rate in m³/h, m³/s and cfm Pe= Static pressure in mm H₂O, Pa and inwg

Impeller diameter in cm: 80

Number of motor poles: 4

Number of blades: 6

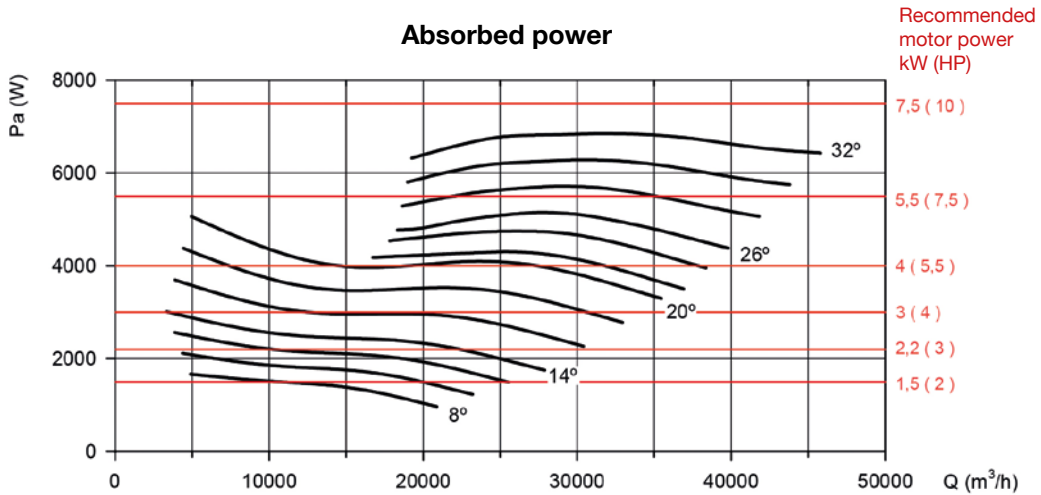
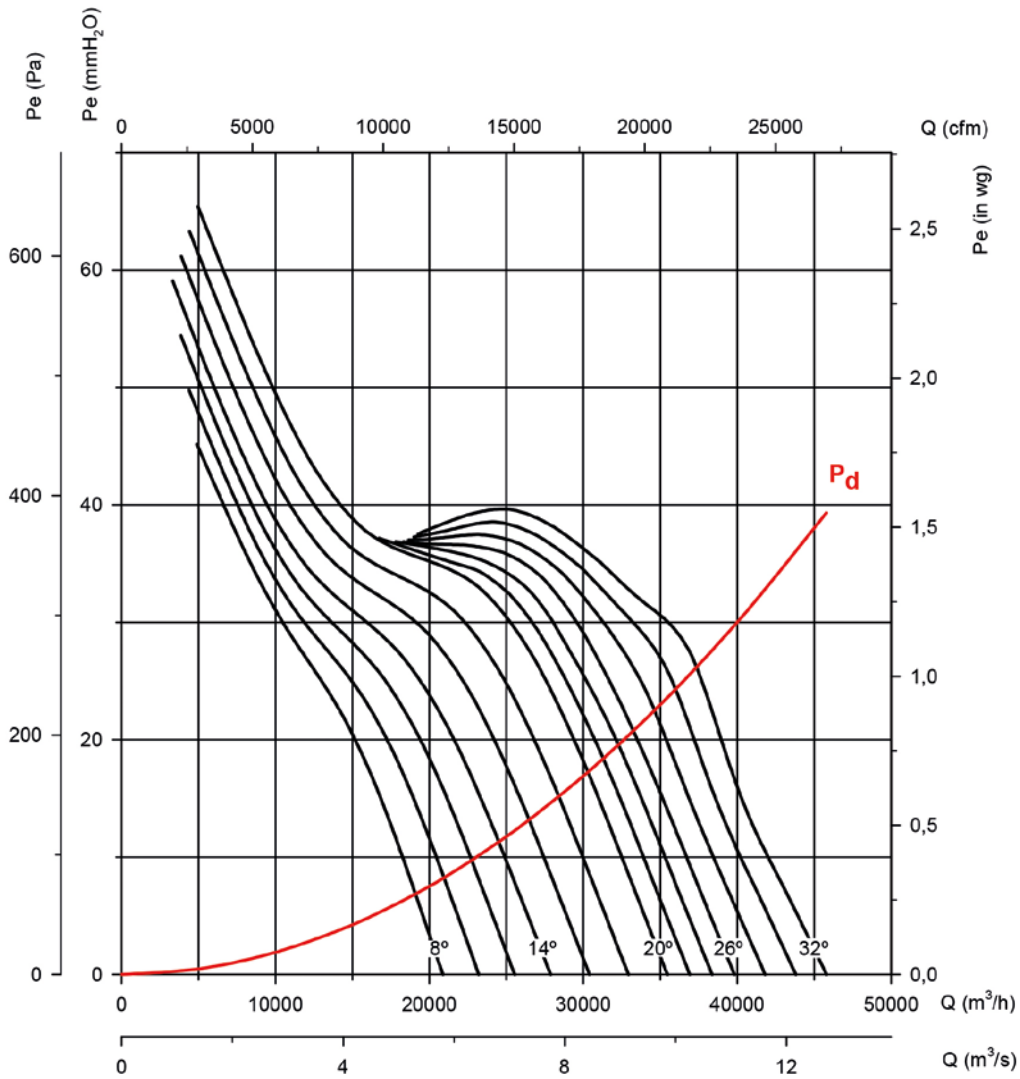

Characteristic curves

Q= Flow rate in m³/h, m³/s and cfm

Pe= Static pressure in mm H₂O, Pa and inwg

Impeller diameter in cm: 80

Number of motor poles: 6

Number of blades: 6

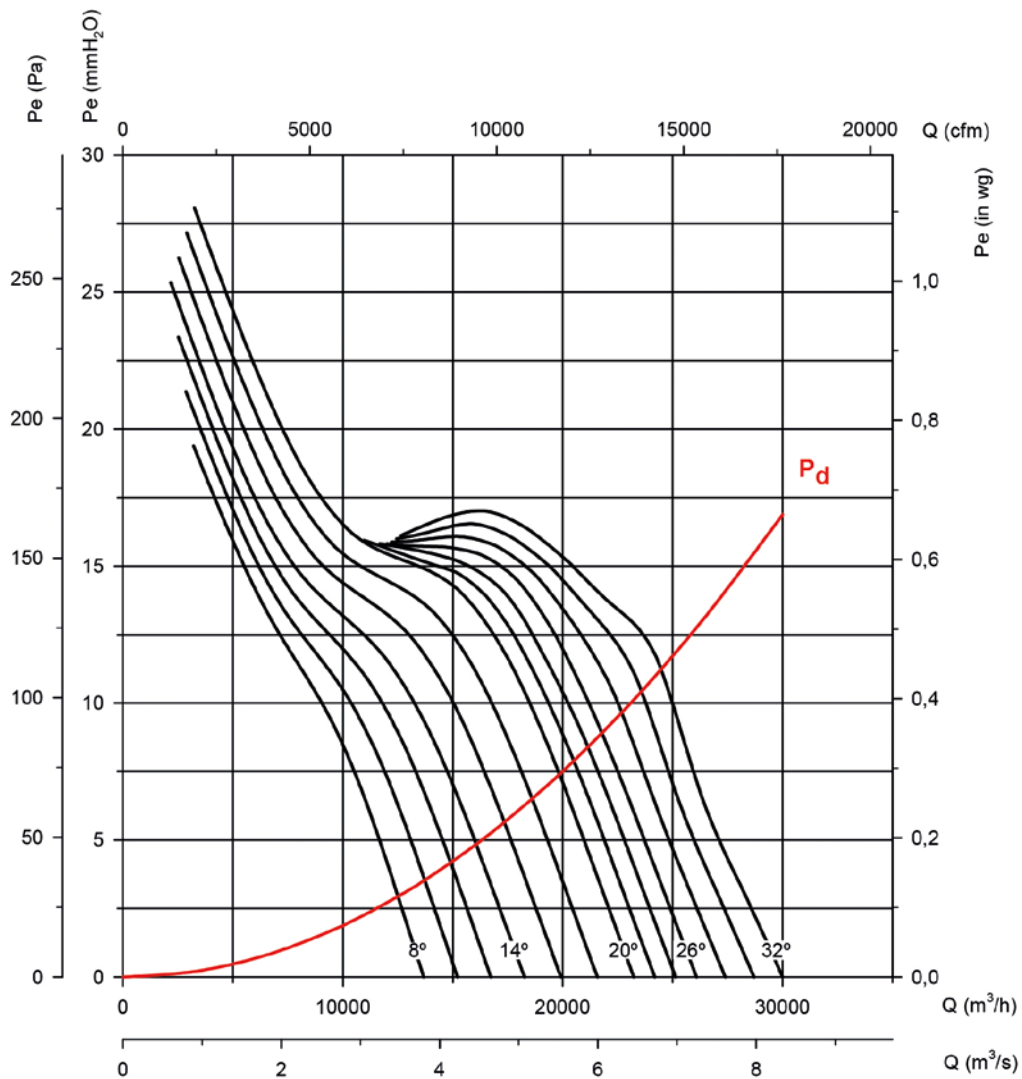

Absorbed power

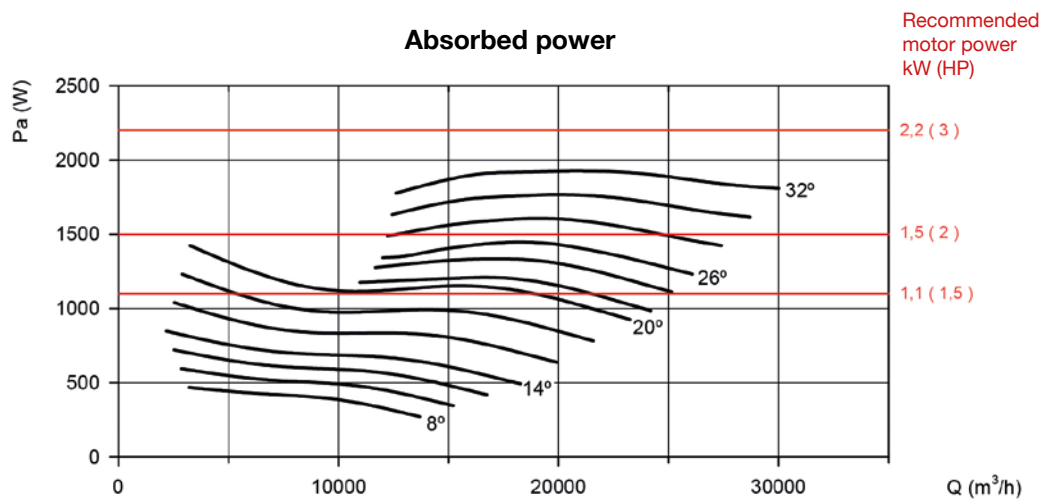

Characteristic curves

Q= Flow rate in m³/h, m³/s and cfm Pe= Static pressure in mm H₂O, Pa and inwg

Impeller diameter in cm: 80

Number of motor poles: 8

Number of blades: 6

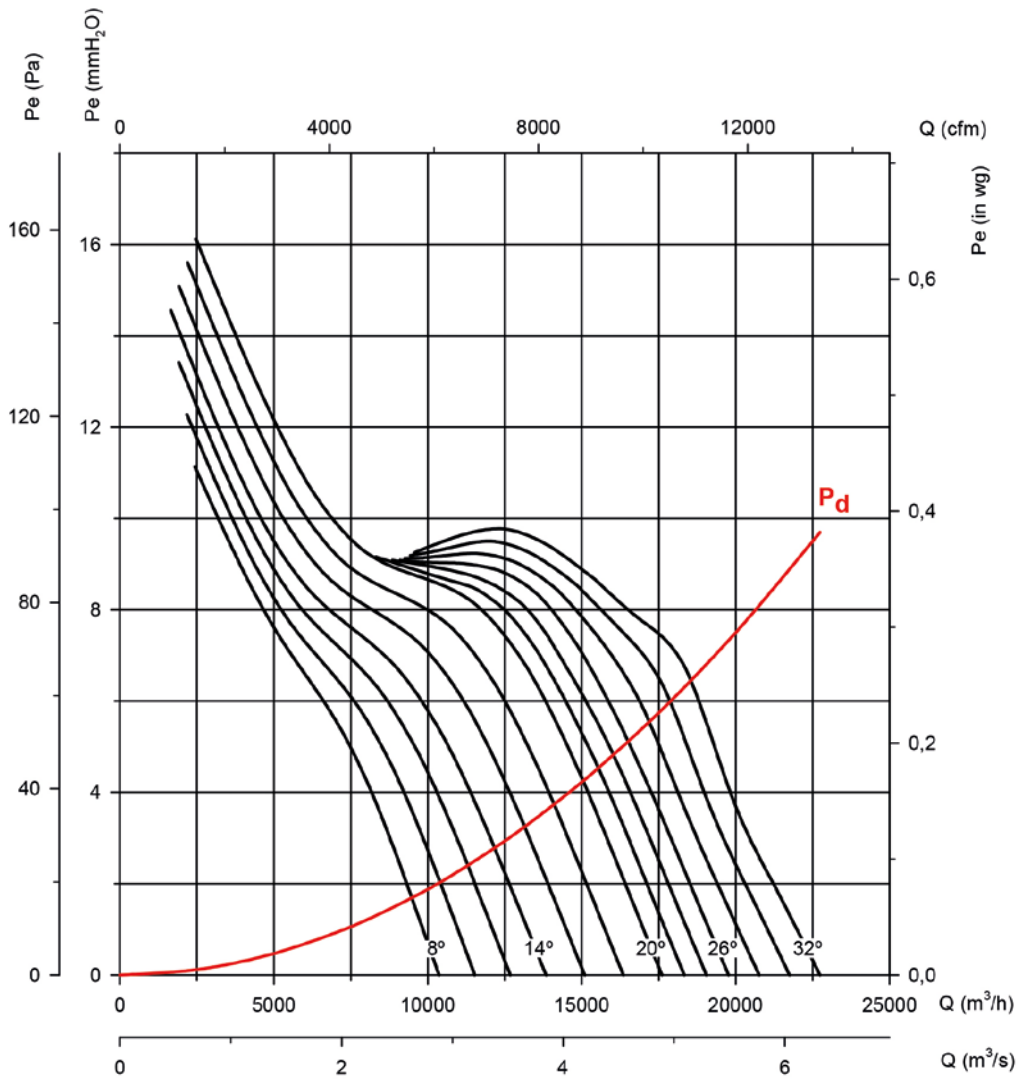

Absorbed power

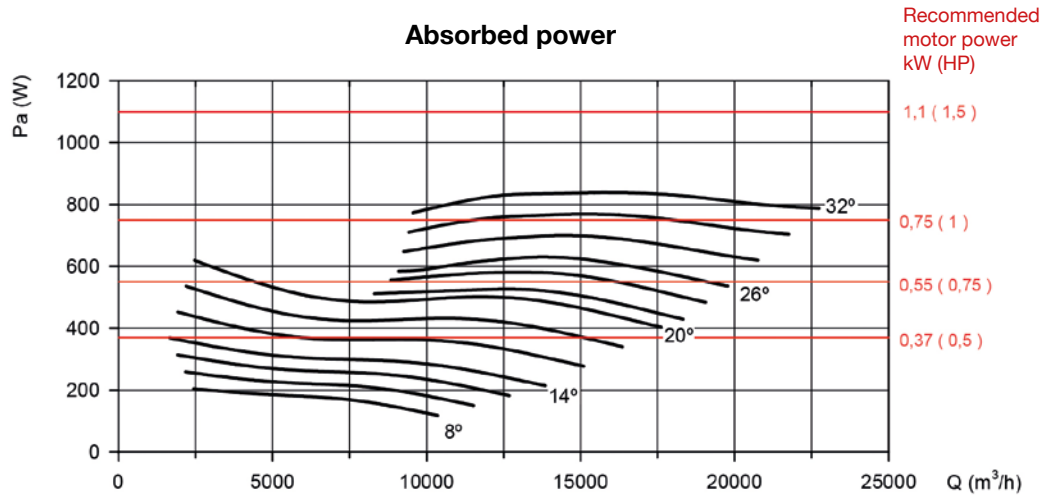

Characteristic curves

Q= Flow rate in m³/h, m³/s and cfm

Pe= Static pressure in mm H₂O, Pa and inwg

Impeller diameter in cm: 90

Number of motor poles: 4

Number of blades: 6

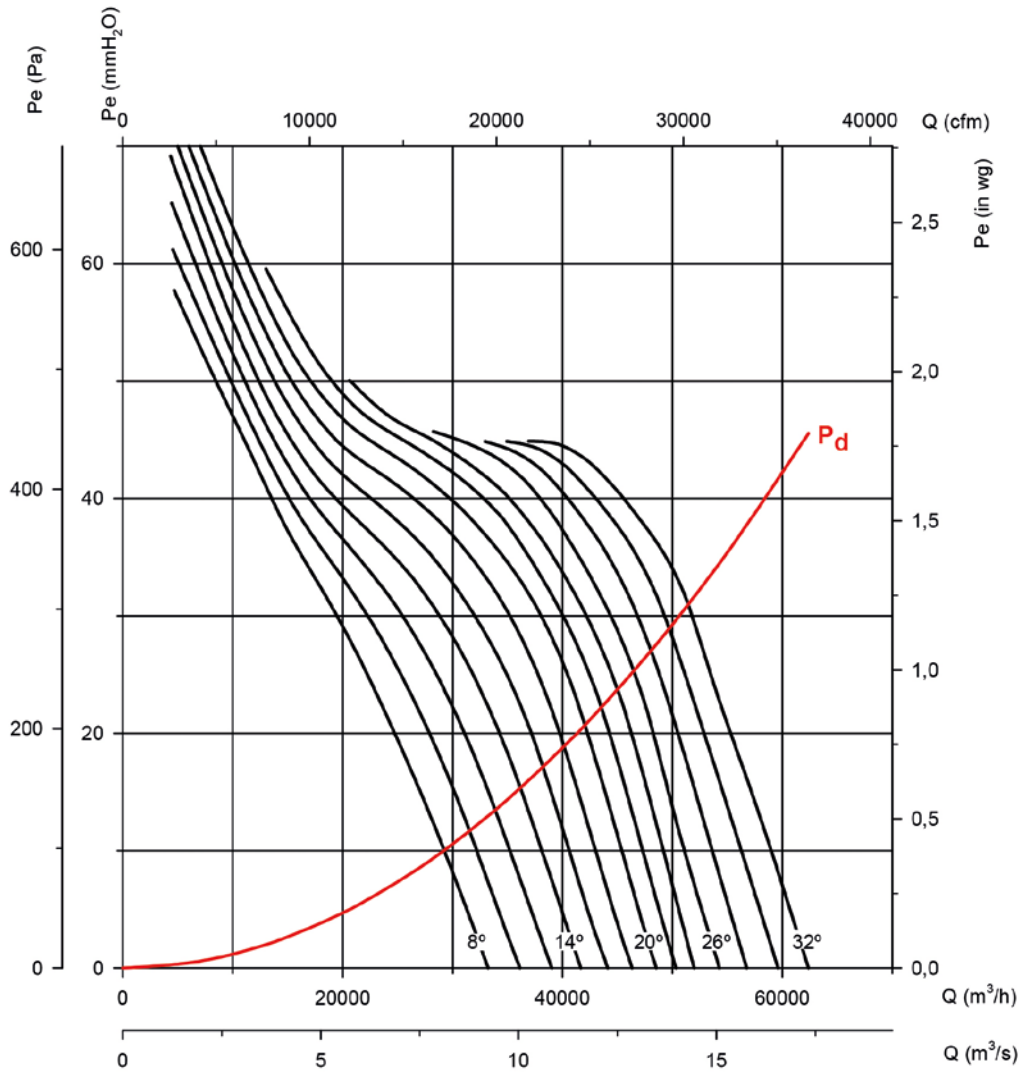

Absorbed power

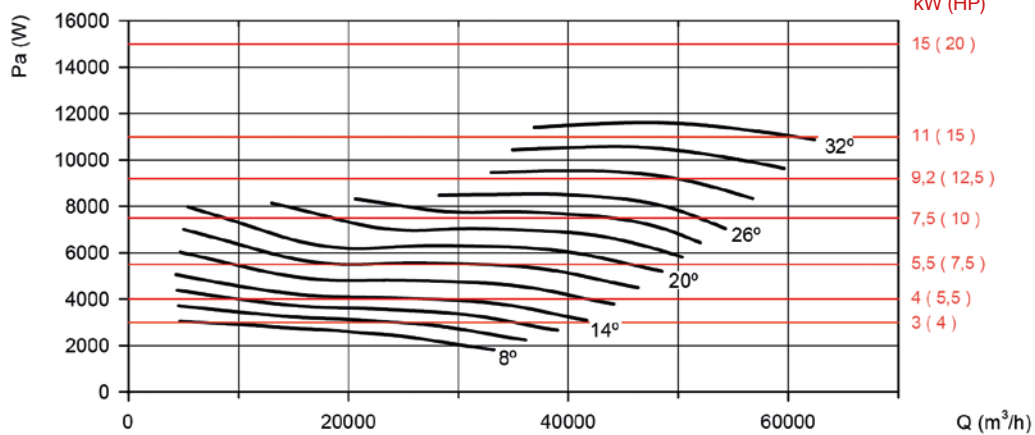

Characteristic curves

Q= Flow rate in m³/h, m³/s and cfm Pe= Static pressure in mm H₂O, Pa and inwg

Impeller diameter in cm: 90

Number of motor poles: 6

Number of blades: 6

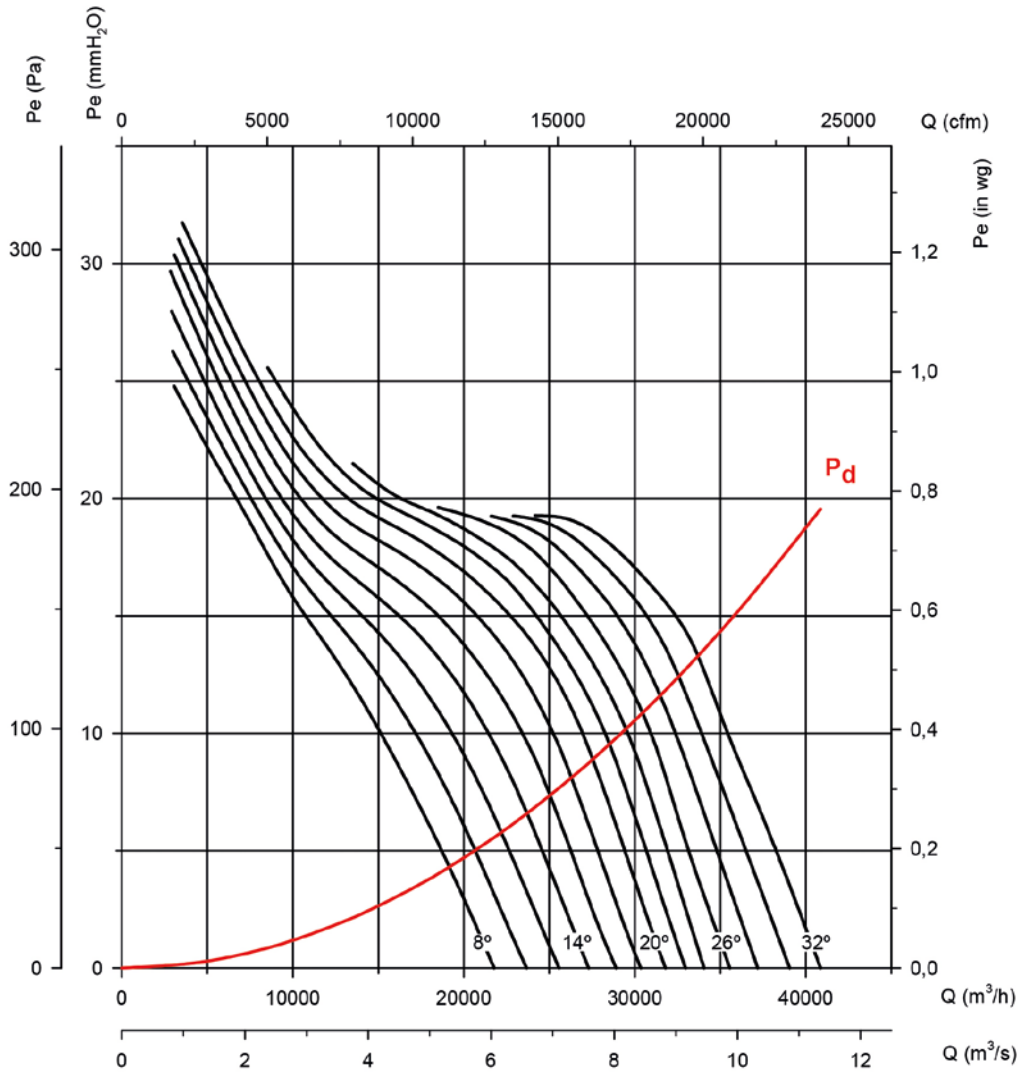

Absorbed power

Recommended motor power kW (HP)

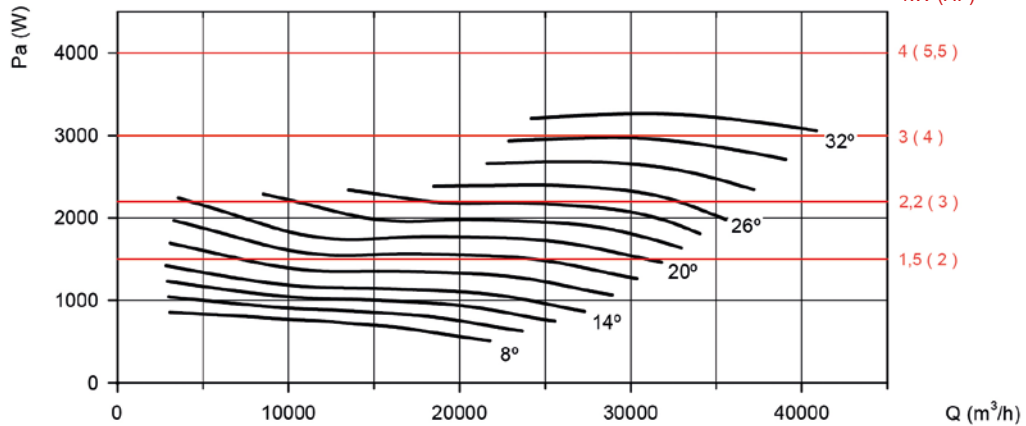

Characteristic curves

Q= Flow rate in m³/h, m³/s and cfm

Pe= Static pressure in mm H₂O, Pa and inwg

Impeller diameter in cm: 90

Number of motor poles: 8

Number of blades: 6

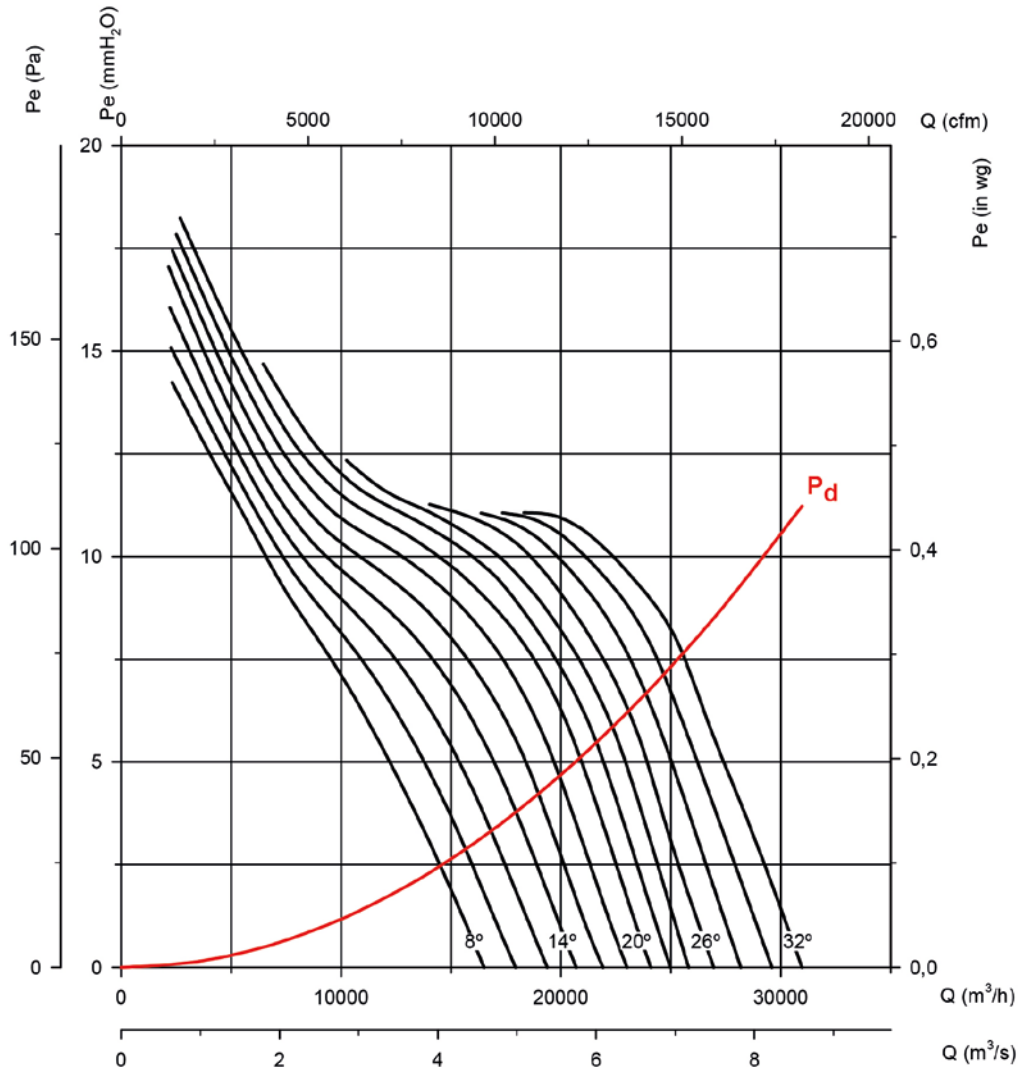

Absorbed power

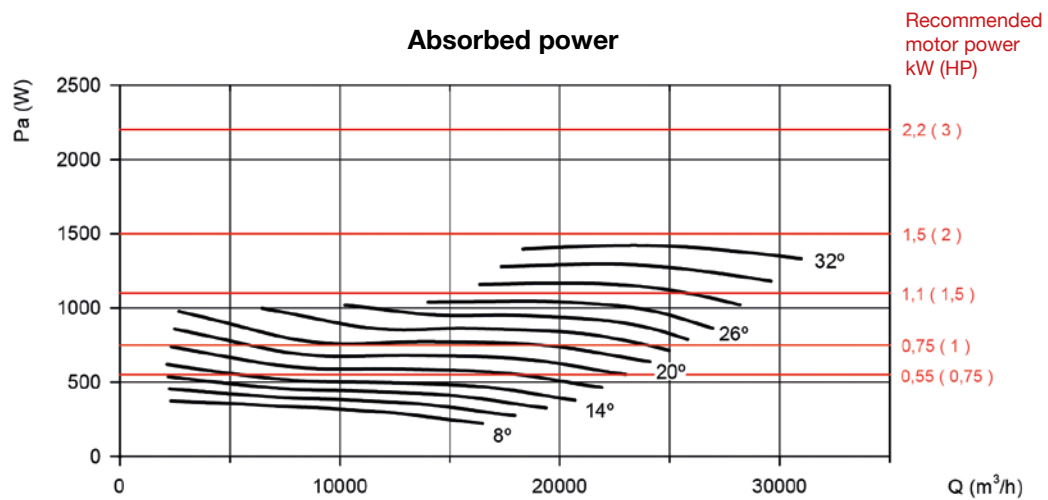

Characteristic curves

Q= Flow rate in m³/h, m³/s and cfm Pe= Static pressure in mm H₂O, Pa and inwg

Impeller diameter in cm: 100

Number of motor poles: 4

Number of blades: 6

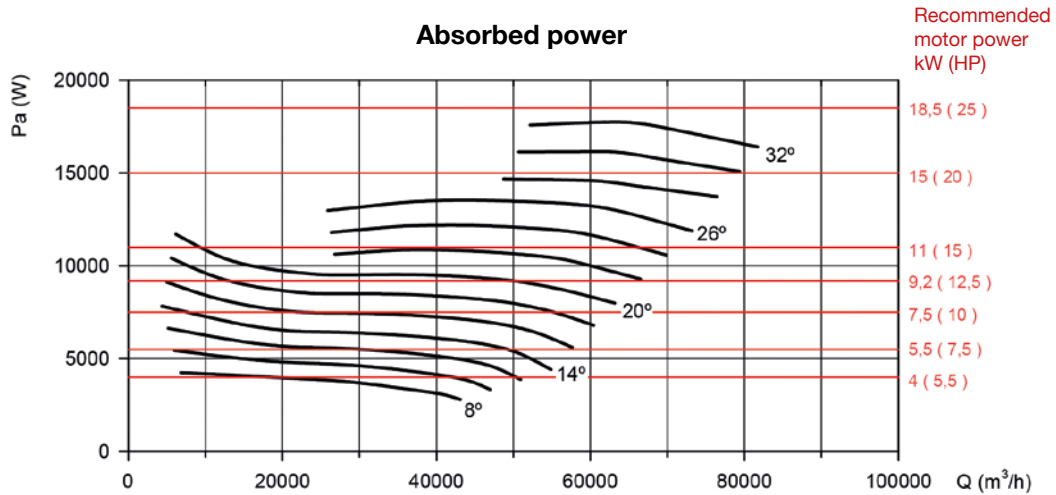
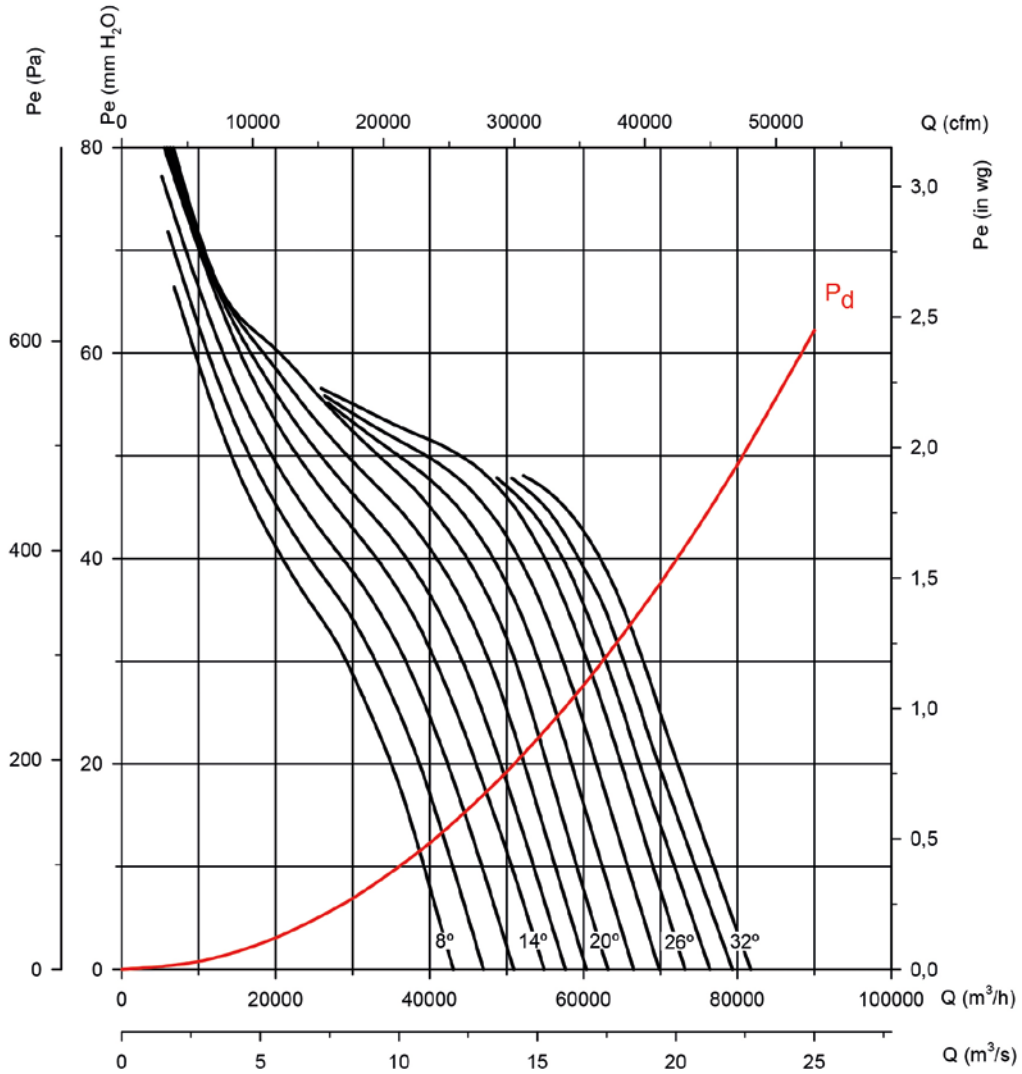

Characteristic curves

Q= Flow rate in m³/h, m³/s and cfm

Pe= Static pressure in mm H₂O, Pa and inwg

Impeller diameter in cm: 100

Number of motor poles: 4

Number of blades: 9

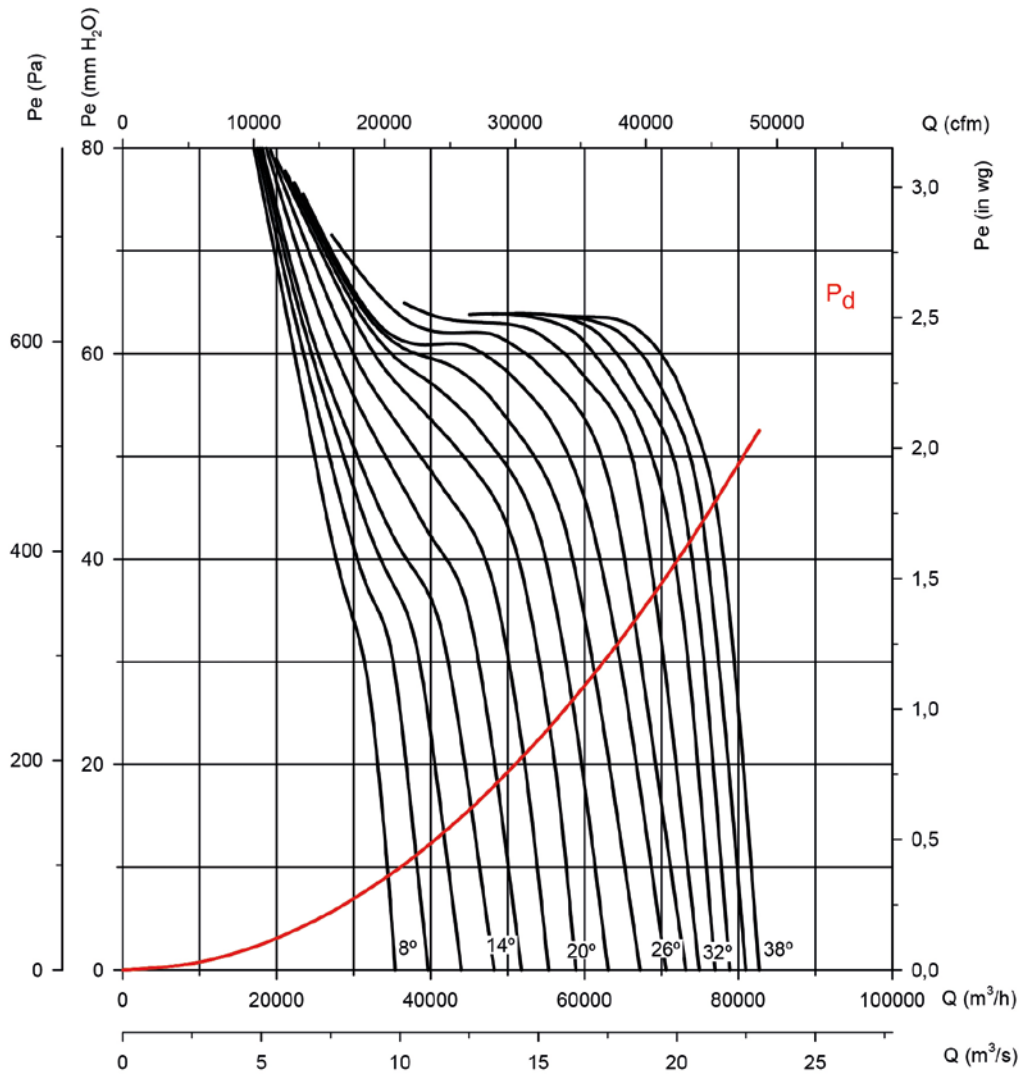

Absorbed power

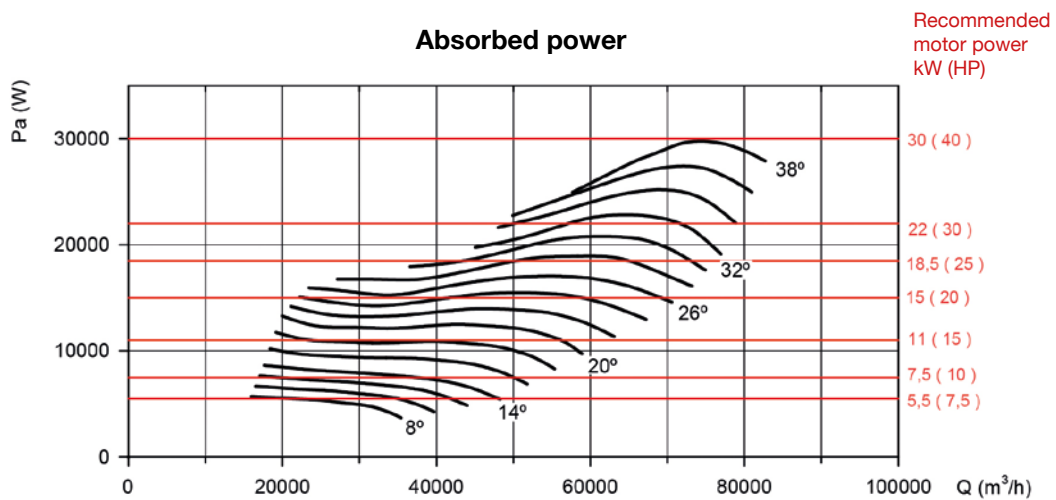

Characteristic curves

Q= Flow rate in m³/h, m³/s and cfm Pe= Static pressure in mm H₂O, Pa and inwg

Impeller diameter in cm: 100

Number of motor poles: 6

Number of blades: 6

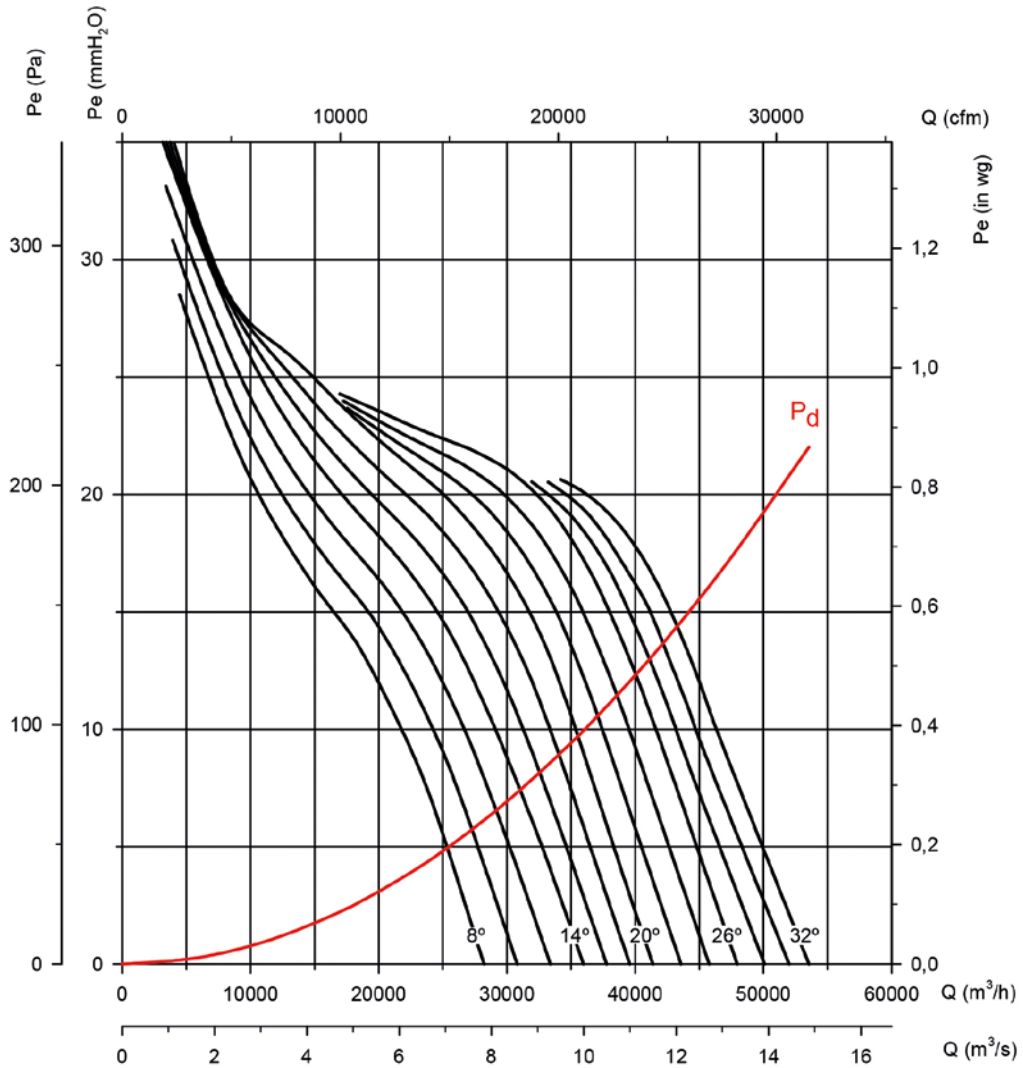

Absorbed power

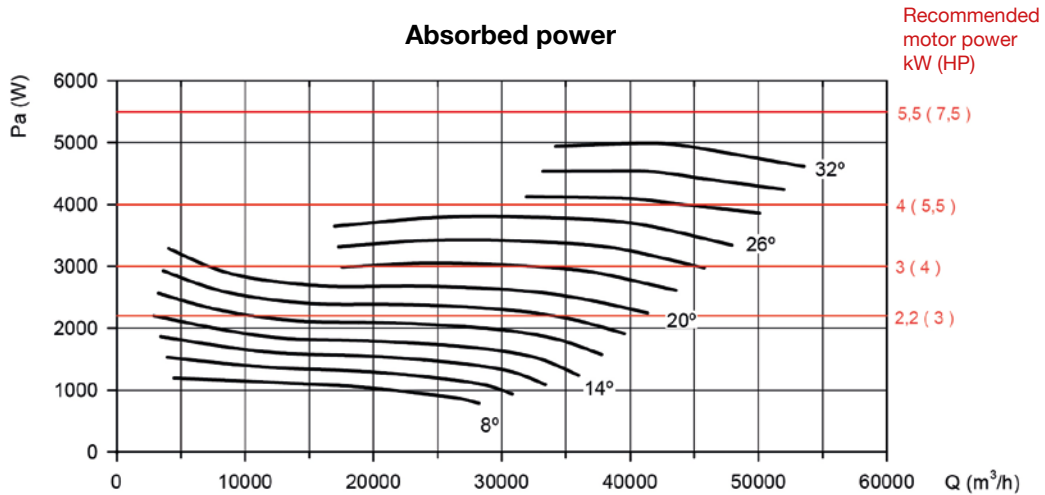

Characteristic curves

Q= Flow rate in m³/h, m³/s and cfm

Pe= Static pressure in mm H₂O, Pa and inwg

Impeller diameter in cm: 100

Number of motor poles: 6

Number of blades: 9

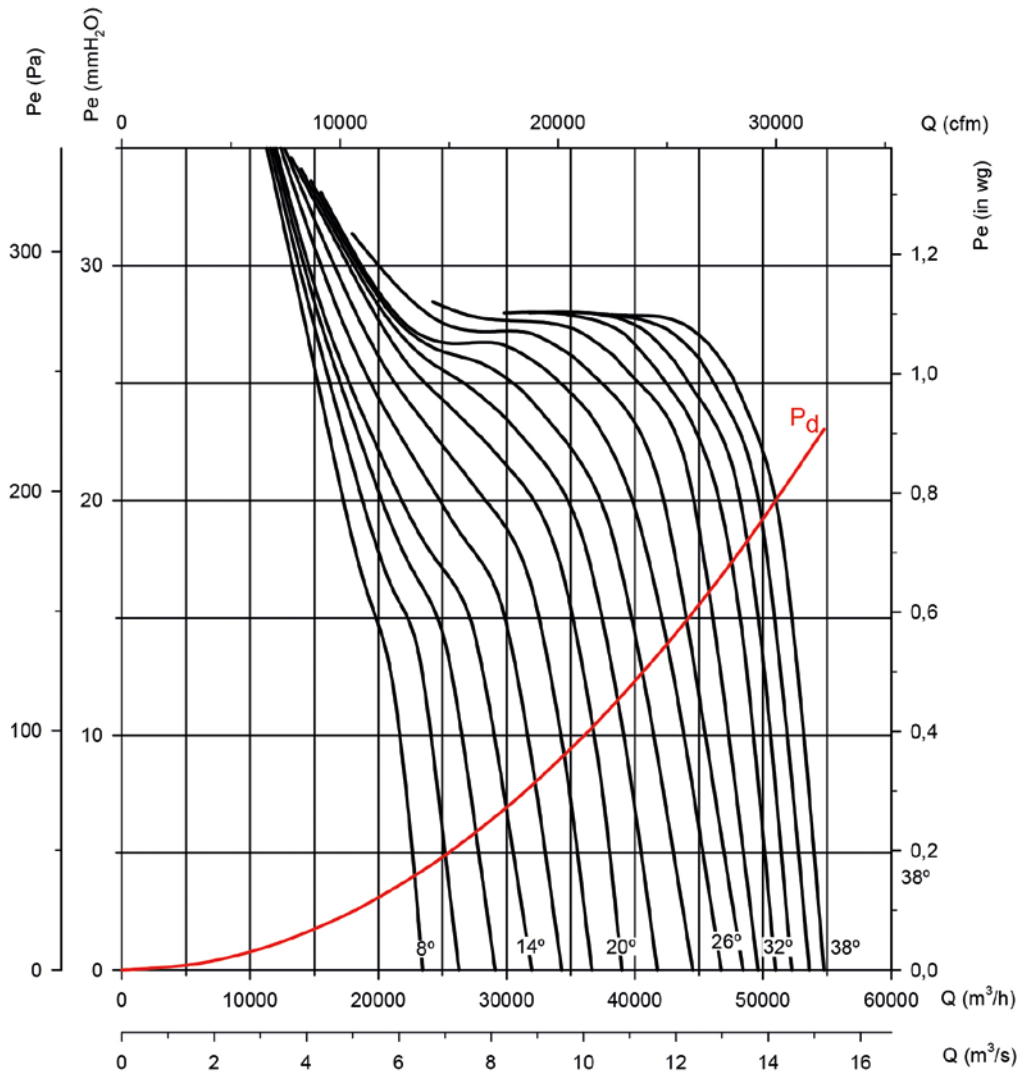

Absorbed power

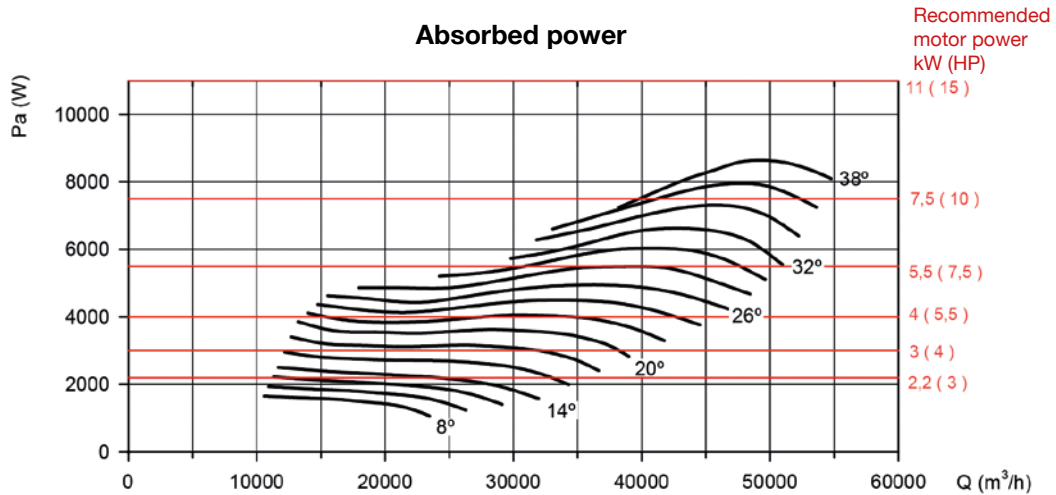

Characteristic curves

Q= Flow rate in m³/h, m³/s and cfm Pe= Static pressure in mm H₂O, Pa and inwg

Impeller diameter in cm: 125

Number of motor poles: 4

Number of blades: 6

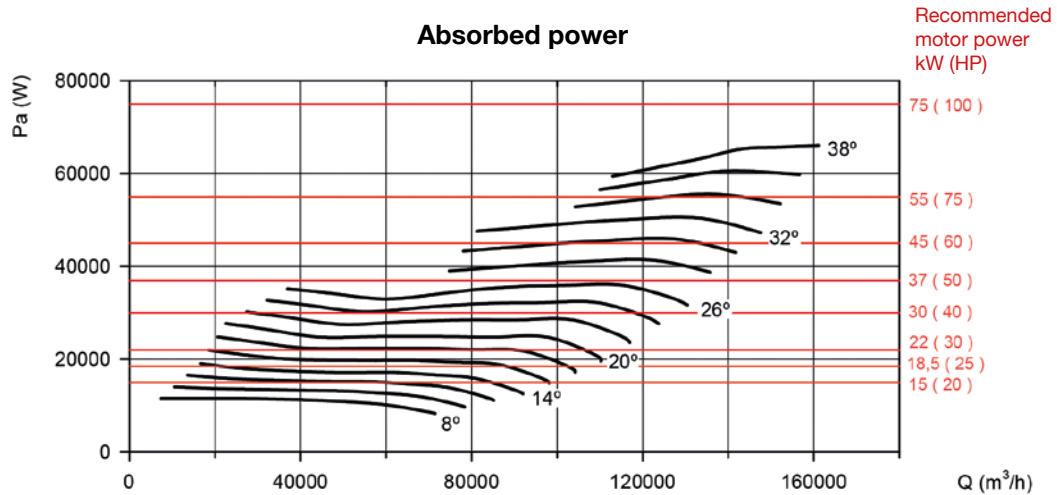
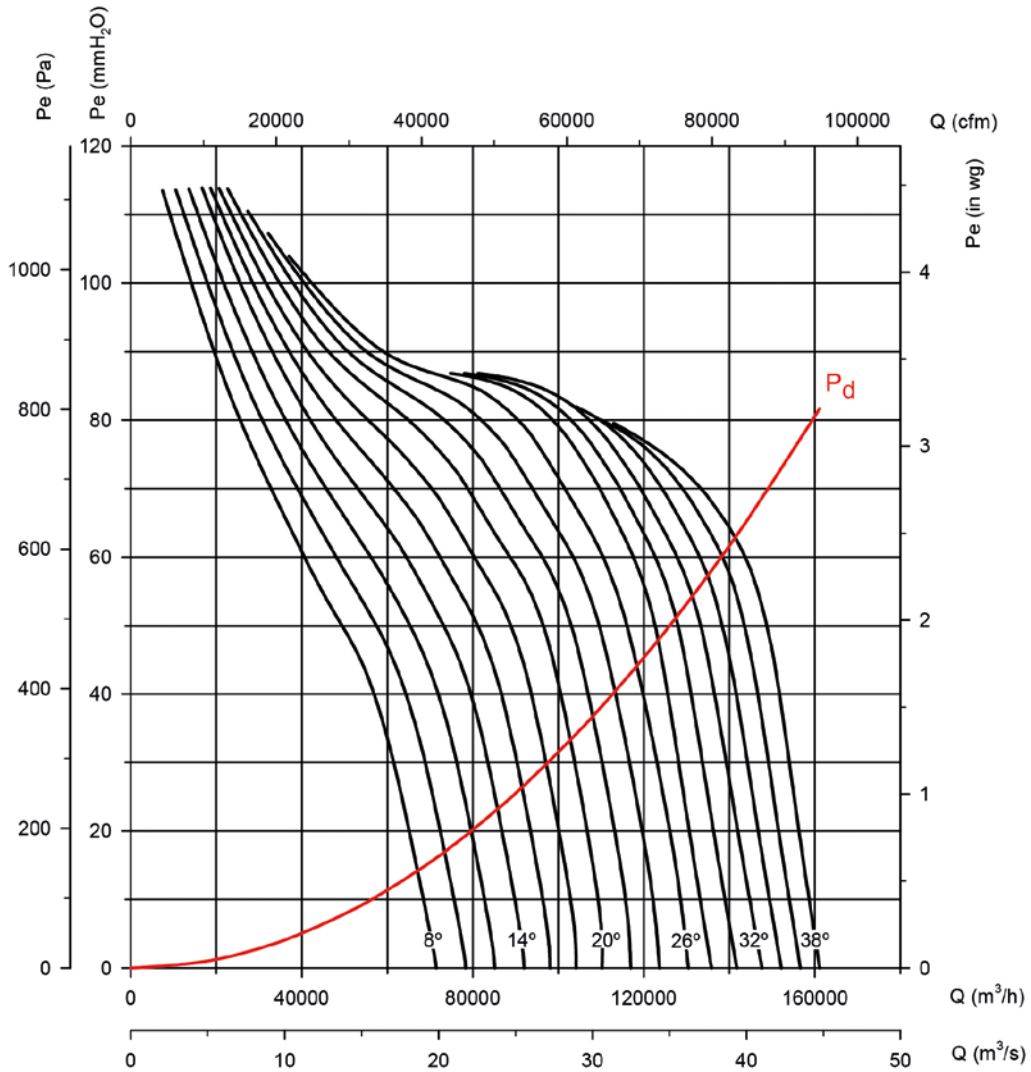

Characteristic curves

Q= Flow rate in m³/h, m³/s and cfm

Pe= Static pressure in mm H₂O, Pa and inwg

Impeller diameter in cm: 125

Number of motor poles: 4

Number of blades: 9

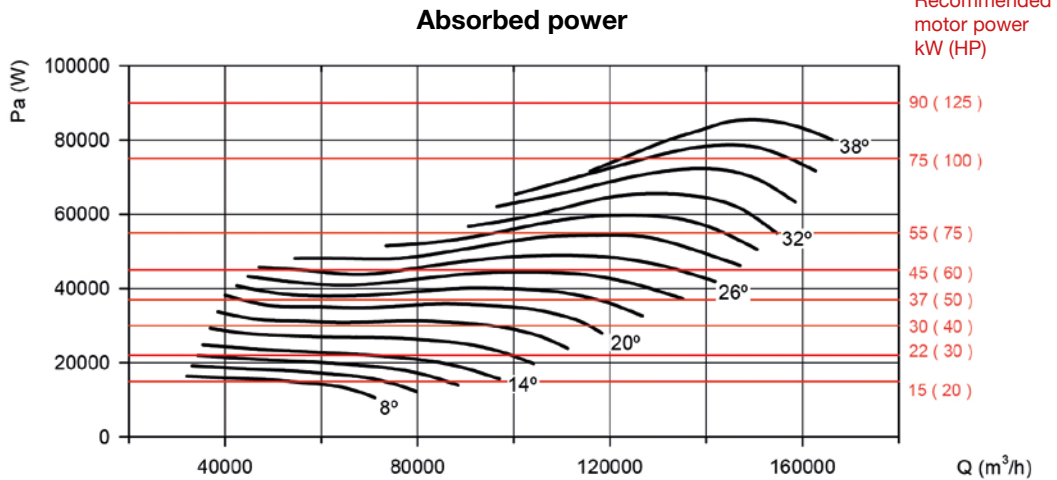
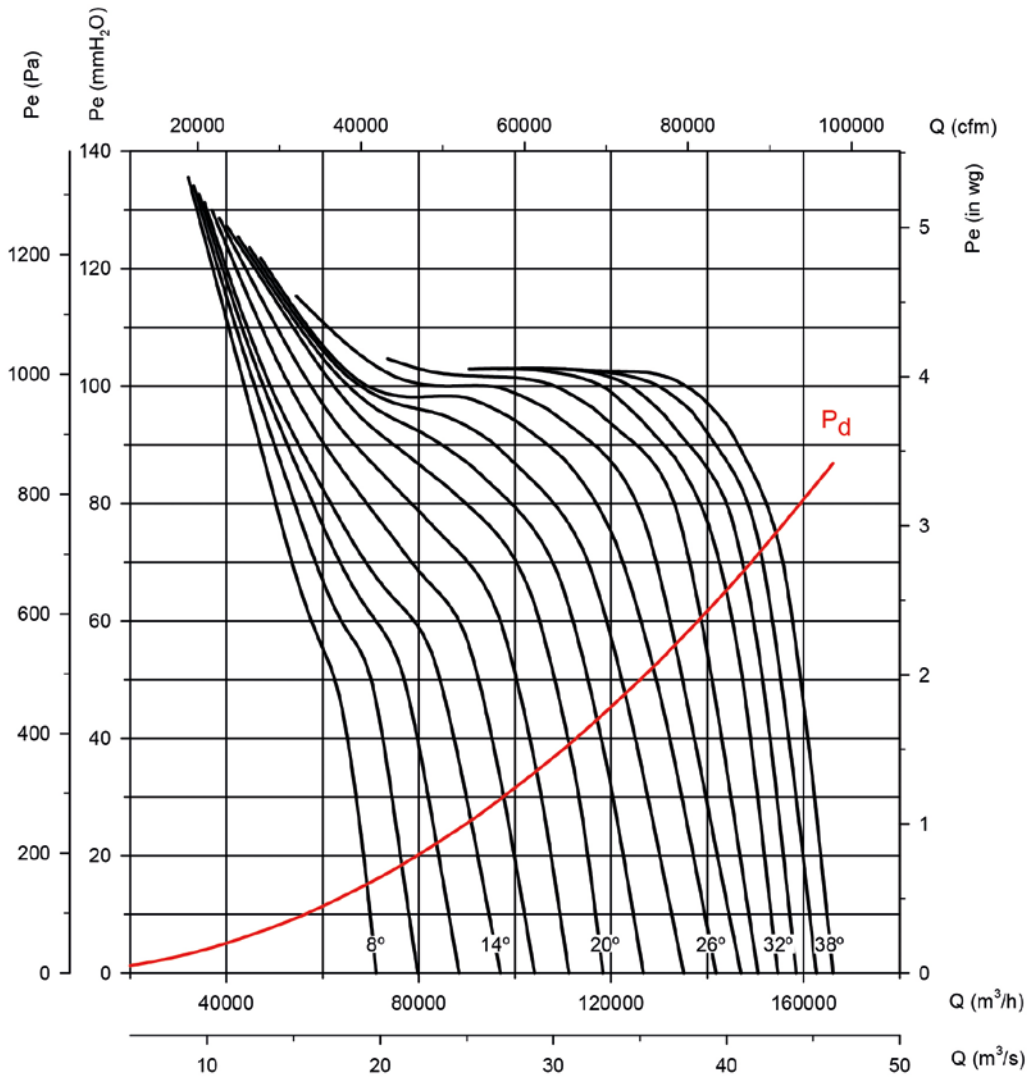

Characteristic curves

Q= Flow rate in m³/h, m³/s and cfm Pe= Static pressure in mm H₂O, Pa and inwg

Impeller diameter in cm: 125

Number of motor poles: 4

Number of blades: 12

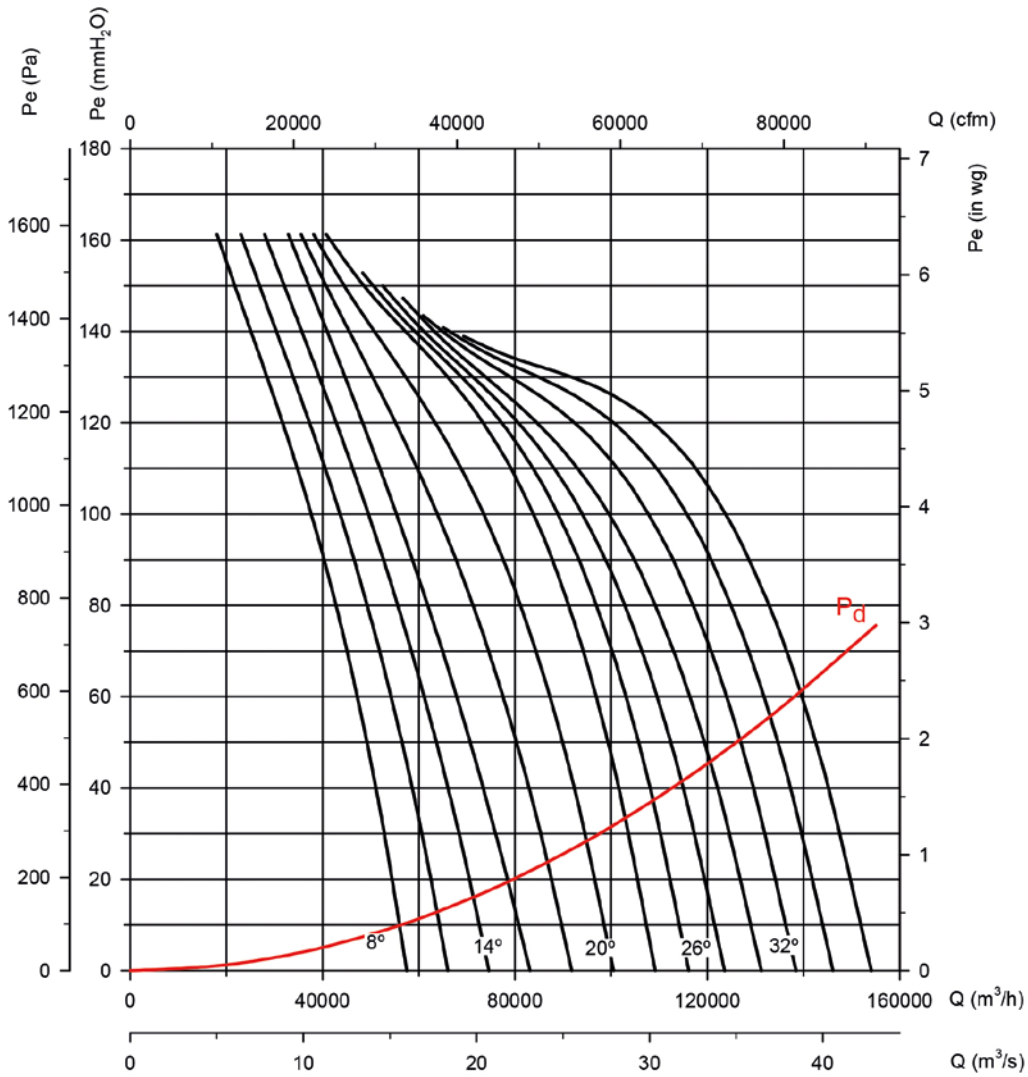

Absorbed power

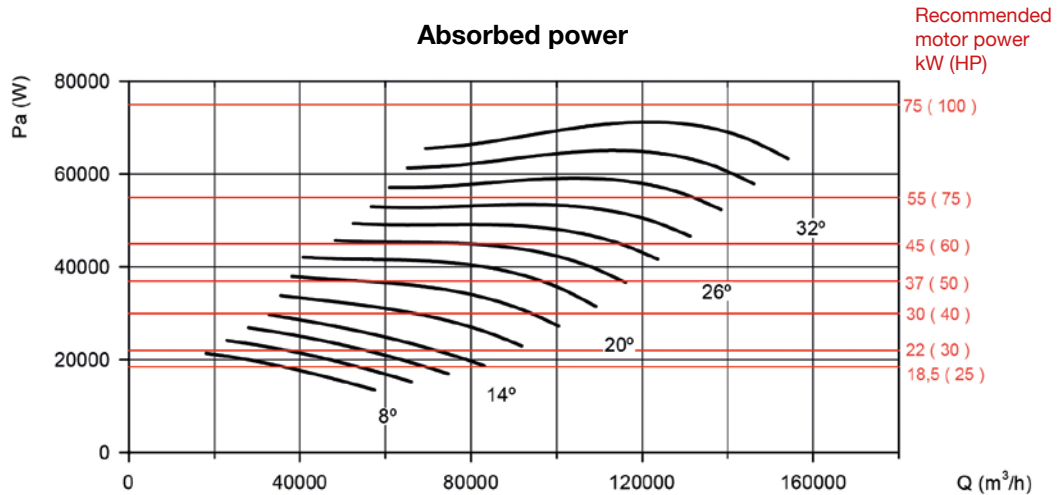

Characteristic curves

Q= Flow rate in m³/h, m³/s and cfm

Pe= Static pressure in mm H₂O, Pa and inwg

Impeller diameter in cm: 125

Number of motor poles: 6

Number of blades: 6

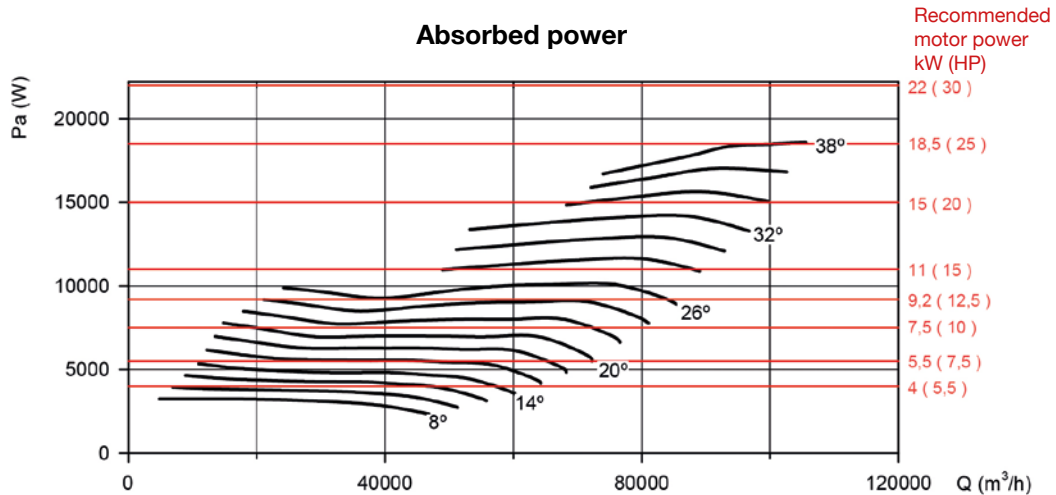
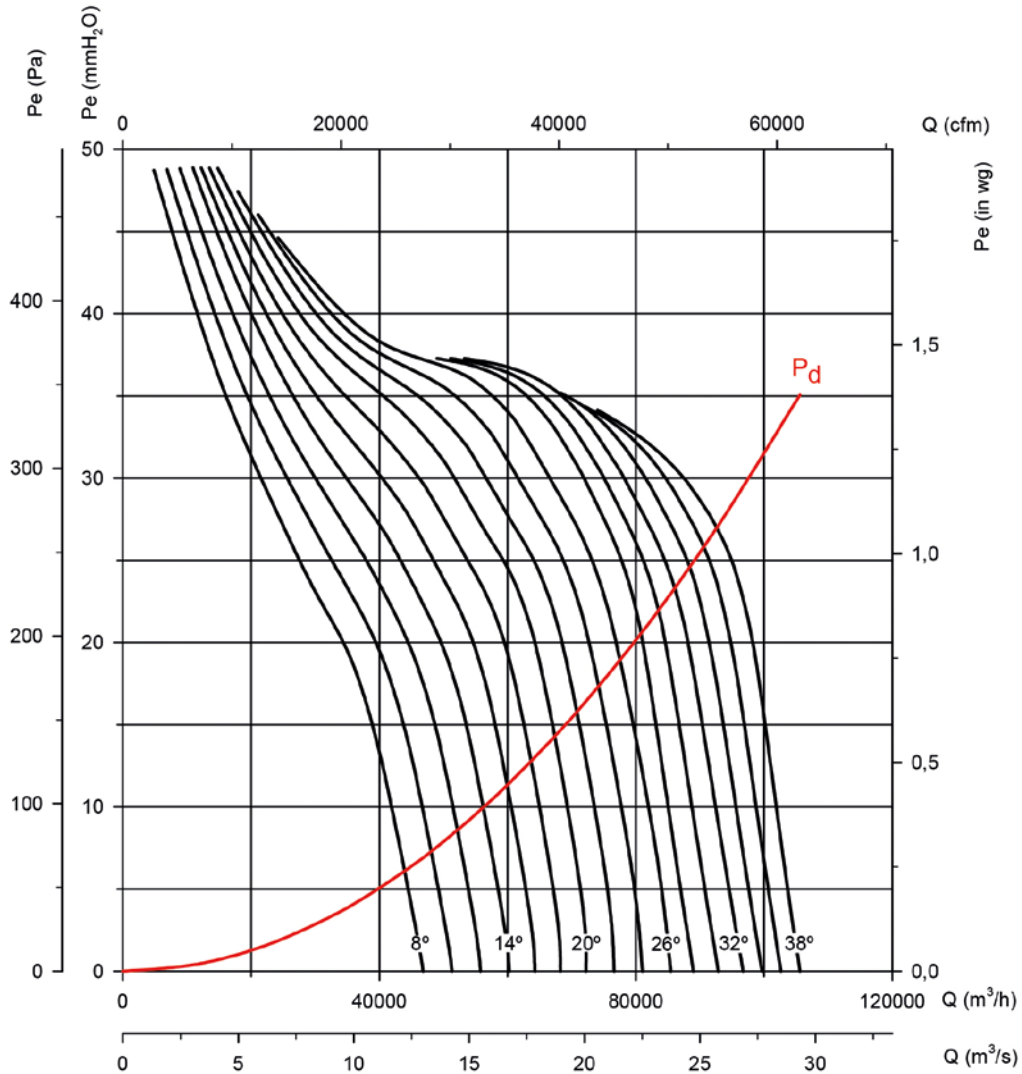

Characteristic curves

Q= Flow rate in m³/h, m³/s and cfm Pe= Static pressure in mm H₂O, Pa and inwg

Impeller diameter in cm: 125

Number of motor poles: 6

Number of blades: 9

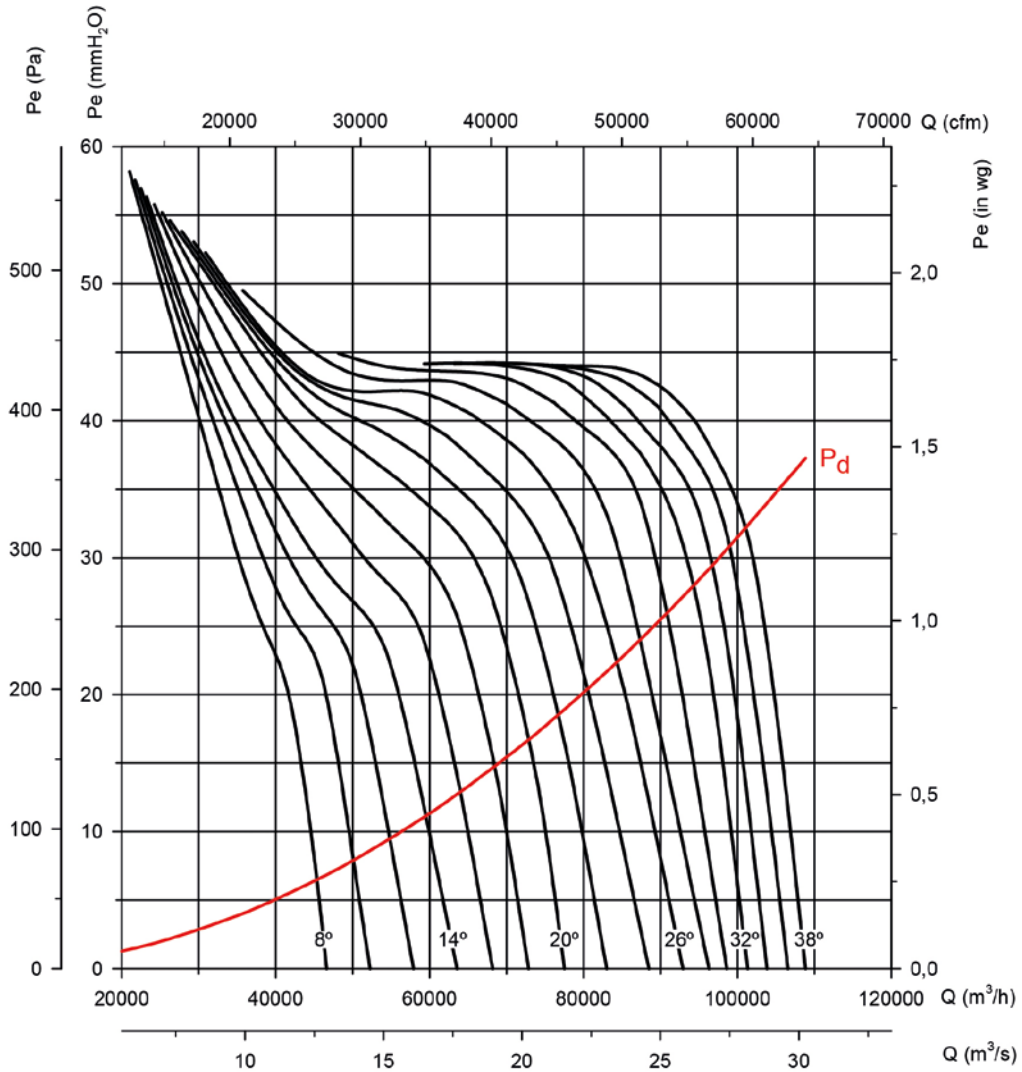

Absorbed power

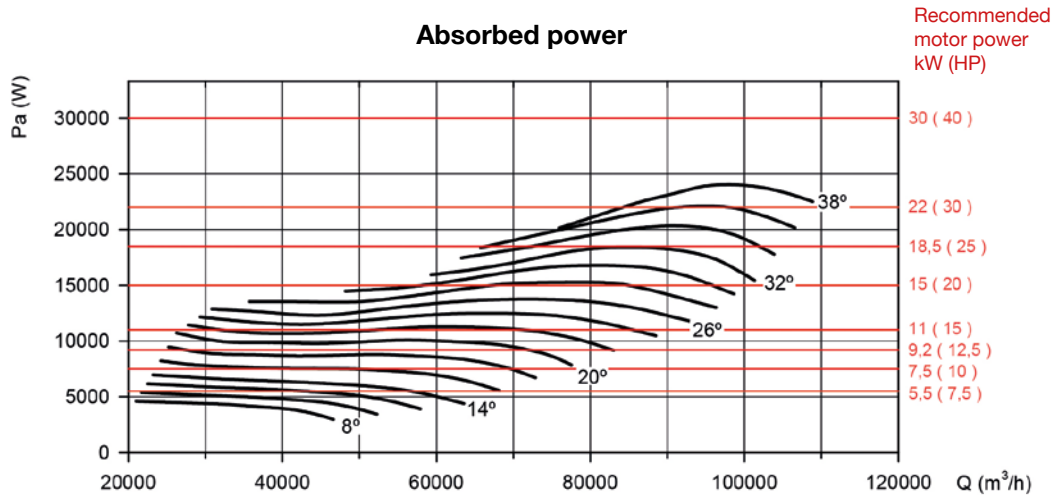

Characteristic curves

Q= Flow rate in m³/h, m³/s and cfm

Pe= Static pressure in mm H₂O, Pa and inwg

Impeller diameter in cm: 125

Number of motor poles: 6

Number of blades: 12

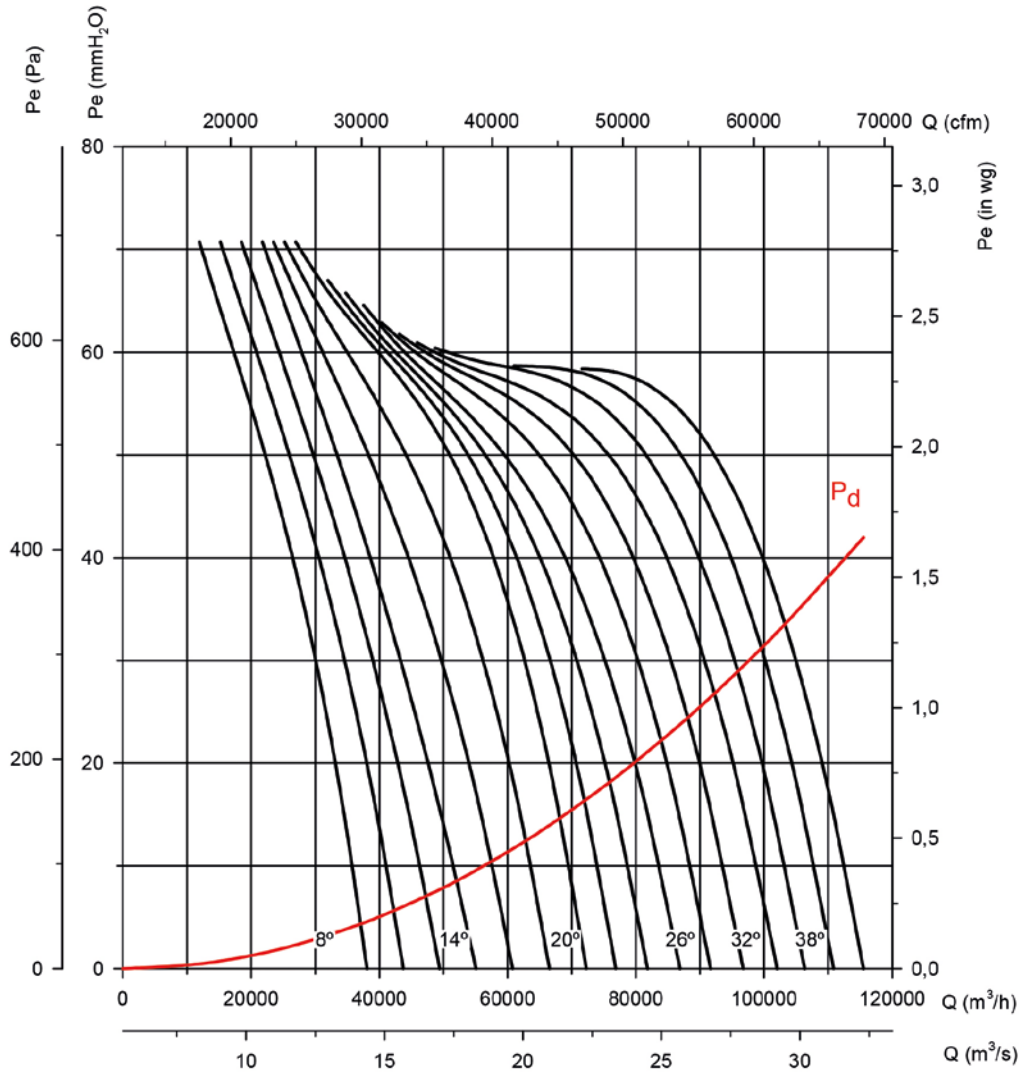

Absorbed power

